



# SAILRITE

Est. 1969

## SNEAK PEEK AT NEW VIDEOS

Learn how to make a mainsail cover, boom tent and bimini p.5

## PROTECT YOUR BOAT WITH THE BEST

New Polyform fenders & buoys p.216

## NEW BIMINI KITS

Now even more options to help you build a custom bimini p.232

# UPGRADE YOUR ULTRA FEED<sup>®</sup>

Create a stationary workstation with the new Ultrafeed Industrial Sewing Table p.108

**TURN THAT FIXER  
UPPER INTO  
YOUR IDEAL BOAT**

WE CAN HELP YOU DO IT!

p.2

## FEATURED CONTENT



### Meet the Sailrite Customer Service Crew

Page 1



### Turn That Fixer Upper Into the Boat You Really Want

Page 2



### 6 Timesaving Tools to Speed Up Any Project

Page 4



### 3 New Sailboat Projects

Page 5



### New Things We're Excited About!

Page 6



### Customer Project Photos

Page 8



### Camp Whitley Pontoon Boat Makeover

Page 161



### Welcome to the 2018 Marine Catalog.

We're excited to share with you our newest product additions, how-to videos and articles and a bit about us behind-the-scenes in this year's catalog.

New for 2018, we've made improvements to the bimini kits—changing the frame sizes, adding Sunbrella webbing and our very best Fast Eye Snap Hooks—to further enhance the quality of the kits. Additionally, brand new step-by-step videos for building these kits are being released early this year.

In this catalog, you'll also find the latest Sailrite branded and supported tool—the Sailrite Blade Foam Cutter. After a year of testing and development, we're pleased to release this economical foam cutter for our DIY customers. It even comes in a storage case!

Here at Sailrite headquarters, we've seen increased demand for DIY boating and outdoor canvaswork equipment and have been growing to meet it. We've added new staff members to almost every department including product entry, human resources, sales and web development. You can see a few of our new faces on the adjacent page.

As always, our new videos continue to drive creativity and we were amazed with all the great customer project photos that were sent to us in 2017. Thank you to all our loyal customers who reached out. We love being able to share in your project experiences.

Thank you again for your continued support. Here's to another great year of DIY!



Matt Grant,  
Vice President



Hallie Grant,  
President

# MEET THE SAILRITE CUSTOMER SERVICE CREW

Put a face with the name of the helpful crew on the other side of the phone or chat!

Our Customer Service Crew is dedicated to helping make your project a success. Whether you need to order more supplies or you get stuck in the middle of a project and need advice, this team is here to help!

260.244.4647 | 800.348.2769 | [Sailrite.com](http://Sailrite.com)



**Jeff F.**

Crew member since 1991



**Eric G.**

Crew member since 2004



**Lisa D.**

Crew member since 2007



**Matt B.**

Crew member since 2011



**Brian J.**

Crew member since 2011



**Zach G.**

Crew member since 2014



**Audrey N.**

Crew member since 2015



**Dawn A.**

Crew member since 2015



**Dillon B.**

Crew member since 2016



**Tara O.**

Crew member since 2017



**Maria S.**

Crew member since 2017



**Audra R.**

Crew member since 2017



**Bill B.**

Crew member since 2017

# TURN THAT FIXER UPPER INTO THE BOAT YOU REALLY WANT

Just like how paint can change the look of a room in your home, new headliner, cushions and flooring can change the look of your boat.

With supplies and how-to videos from Sailrite, you can take on a fixer upper boat and give it a brand new look. Our Project Powerboat is a great example of the difference a few DIY projects can make!

When you're ready to get started, browse our how-to library full of hundreds of project tutorials and tips. There's even a video series that will teach you how to sew! Start today at [Sailrite.com/How-To](https://www.sailrite.com/How-To).

BEFORE

AFTER

## When You Do-It-Yourself, You'll Get:



### CUSTOM RESULTS

Create exactly the look you want. You can also customize solutions to best suit the unique design of your boat and how you use it.



### SELF-SUFFICIENCY

When you know how to sew your own canvaswork and repair your own sails, you never have to wait on a shop to do your work for you.



### SAVINGS

When you DIY, you can customize work for less than contracting similar work.

### HAVE A QUESTION? GIVE US A CALL!

If you're not sure what materials you need to get started or if you get stuck mid-project, no worries! We're here to offer personalized support to help you get back on track.

800.348.2769 | 260.244.4647

# 6 Timesaving Tools to Speed Up Any Project

Work smarter, not harder. This old adage is one we really believe in. That's why we're always looking for tools that will make DIY projects from marine canvaswork to upholstery projects more efficient while still maintaining professional-quality results. In this spirit, we've come up with a list of our six top tools that will help you achieve great looking results in less time!

You can find all of these handy tools and many more at [Sailrite.com](http://Sailrite.com)



## SAILRITE CANVAS PATTERNING RULER

This clear acrylic ruler features holes every quarter-inch to help you easily pattern perfect circles with a set radius, or scribe a line a set distance from the edge of the fabric. p.134

**SPEEDY STITCHER SEWING AWL**  
A great tool for making quick canvas or leather repairs, the Speedy Stitcher sew lock stitches just like a sewing machine! This tool comes in a complete kit with everything you need to get started, and extra needles conveniently store right in the handle, so it's easy to keep at the ready in your toolbox. p.127



## SAILRITE EDGE HOTKNIFE

Hem less when you heat seal the edges of your synthetic fabrics with a hotknife! The Sailrite Edge Hotknife quickly and neatly cuts rope, webbing and synthetic fabrics with no unraveling for a clean, precision cut every time. Plus, it heats up in seconds so you're always ready to go. p.137



## SAILRITE BLADE FOAM CUTTER

Quickly and easily cut foam to size with this high quality foam saw. The two-blade system creates less bounce and will easily cut through a full range of foam densities. p. 91

**PRES-N-SNAP INSTALLATION TOOL**  
The Pres-N-Snap is a professional-quality fastener installation tool that condenses the process of installing fasteners into just one step—which you can do with one hand! This versatile tool comes with six standard dies to install standard Ligne 24 snap fasteners and #1 plain washer grommets. Additional dies can be added on to make this your go-to installation tool. p.175



## GINGHER 8" SCISSORS

Designed to smoothly cut through multiple layers of fabric, these scissors are comfortable to hold and can be re-sharpened, making them your go-to shears for years to come! p.133

# 3 NEW SAILBOAT PROJECTS! Protect Your Flaked Mainsail & Create Shade for Yourself

We've been sewing up new canvas projects for our Islander 37 project sailboat. Learn how to sew your own mainsail cover with our new and improved free video. We also made panels to turn your mainsail cover into a boom tent and a new 2-bow bimini, both with free, step-by-step how-to videos.

Learn More at [Sailrite.com/How-To](http://Sailrite.com/How-To)

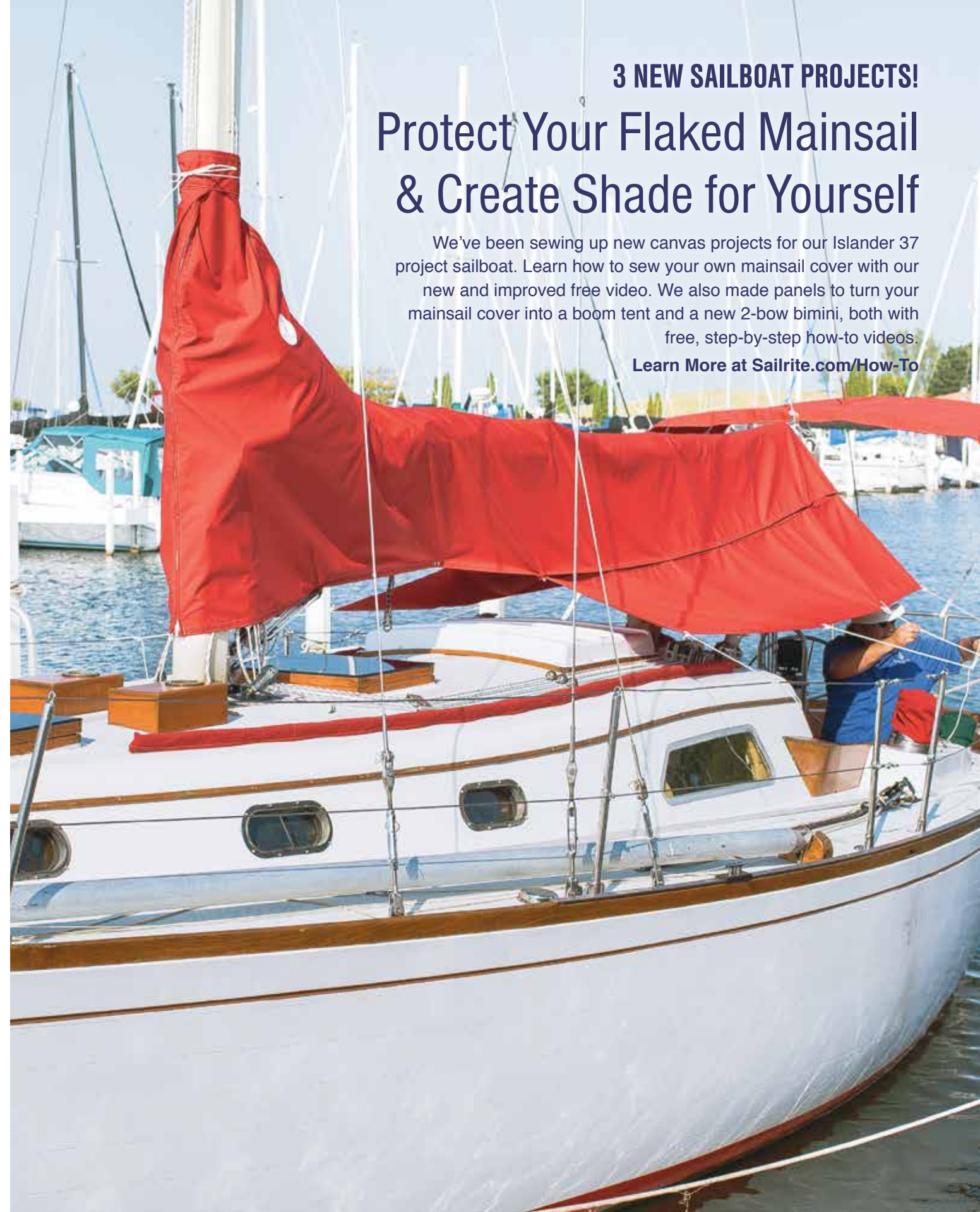

*New!*  
**SUNBRELLA  
 MAKERS  
 COLLECTION**

The newest upholstery collection from Sunbrella pays homage to artisans and traditional textile weaving techniques to bring a modern twist to age-old designs. These fabrics will bring a worldly, traveled look to any boat cabin. **p. 48**



*New!*  
**COLORED  
 ZIPPERS  
 BY YKK®**

Zippers that blend into your canvas! New from YKK®, these #10 Vision zippers have tape and teeth that match six popular shades of Sunbrella canvas. **p. 157**



**IMAR CLEANING BUCKETS**

Choose from 3, new, all-inclusive cleaning kits from IMAR. Get everything you need for taking the best care of your clear vinyl, your boat deck or both. Kits even include buckets and sponges! **p. 164**



*New!*  
**POLYFORM FENDERS & BUOYS**

We now stock high quality fenders and buoys, in a variety of sizes and styles, from Polyform US. Find just the fender you need for rafting and docking. **p 216.**

*New!*  
**ULTRA FEED®  
 INDUSTRIAL  
 SEWING TABLES**

Create a sturdy, fixed sewing station for your Ultrafeed Sewing Machines with this new Industrial Table package. Choose between the table-only and a package with the Workhorse Servo Motor for slow speed power and quiet sewing in a non-portable set-up. **p.108**



See what other DIYers like you are creating

See more projects and share your own project photos on our Facebook page!

[Facebook.com/sailrite](https://www.facebook.com/sailrite)



Kendra S.



Debbie G.



Sue S.



Walter R.



Doug H.



Glen C.

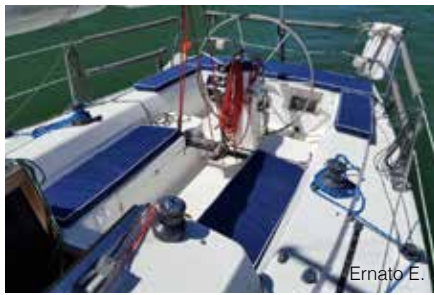

Ernato E.



Ed M.



Rob S.



Dotty G.



Andrew H.



Wayne D.

# TABLE OF CONTENTS

## FABRIC

Sunbrella Introduction .....	13
Sunbrella Marine Grade .....	14
Sunbrella Plus.....	19
Sunbrella Supreme & Unity .....	20
Top Notch 9.....	21
SeaMark .....	22
Webblon Regatta.....	23
Herculite Riviera .....	23
Stamoid .....	24
Top Gun.....	25
Marine Topping .....	26
Brun-Tuff Camo Vinyl.....	26
Cotton Duck.....	26
Cordura .....	26
Top Gun 1S .....	27
Odyssey .....	28
Sur Last .....	29
Softouch .....	30
Shelter-Rite.....	31
Foam Backed Headliner.....	32
Hull Blanket Headliner/Hull Liner.....	32
Morbern Seabrook Channeling Fabric.....	33
Naugahyde Universal.....	34
Naugahyde All-American .....	35
Seabrook Vinyl.....	36
Morbern Hexx.....	37
Morbern Shock.....	37
Allsport 4-Way Stretch Vinyl .....	38
Naugahyde Nauga Soft.....	39
Sunbrella Upholstery.....	40-65
Geobella.....	66-71
Ultrasuede HP .....	73
Phifertex Plus.....	75-76
Phifertex Mesh.....	77
Chilewich .....	78
Infinity .....	79
Ripstop Spinnaker Cloth.....	80
Nylon Bag & Flag Cloth .....	80
Dacron .....	81
Targa Premium Canopy .....	82
AirX 700 Premium Spinnaker Cloth .....	82
Sailmaker's Leather .....	82
Insignia Material .....	83
Sail Numbers .....	83
Trampoline Mesh.....	84
Mesh & Netting.....	85
Patterning Material .....	86
Boat Blanket .....	87
Window Material.....	88
Evolution Block-It.....	90
Thermozite Thermal-Acoustic Insulation .....	90
Tonneau Cover.....	90
Trunkliner.....	90

## FOAM & PILLOWS

Foam.....	91-93
Sailrite Blade Foam Cutter.....	94
Silk Film .....	94
Polyester Batting .....	94
Cushion Underlining.....	94
Button Forms .....	94
Pillow Forms .....	95

## SEWING MACHINES

Ultrafeed Sewing Machines .....	96-103
Ultrafeed Sewing Machine Add-Ons.....	104-106
Ultrafeed Collapsible Table.....	107
Ultrafeed Industrial Sewing Tables .....	108
Workhorse Servo Motor .....	109
Sailrite Fabricator Sewing Machine.....	110-113
Sailrite Professional Sewing Machines.....	114-117
Motors .....	118
Belts .....	118
Presser Feet .....	119
Other Parts .....	120-121

## SEWING

Thread Stands .....	122
Binders .....	123
Sewing Machine Needles .....	124-125
Hand Sewing Needles.....	126
Twine .....	127
Upholstery Thread.....	128
PTFE Lifetime Threads .....	129
Polyester Thread .....	130
Rotary Cutters & Snippers .....	132
Scissors.....	133
Marking & Measuring .....	134
Sewing Kits .....	135
Pins.....	135
Sewing Guides .....	136
Hotknives.....	136-137
Repair Kits.....	138

## TRIM

Basting Tape .....	139
Binding & Facing .....	140-144
Hide'n Gimp .....	145
Piping & Trim .....	146-147
Webbing .....	148-149
E-Z Lace Supreme .....	150
Hook & Loop.....	151
Trim & Repair Tapes .....	152
Luff Reinforcement .....	153
Weather Stripping .....	154
Zippers .....	155-160

## HARDWARE & TOOLS

Canvas Care.....	162
Metal Care .....	162
Adhesives .....	163
Boat Care Kits .....	164
Vinyl Care .....	164
Multipurpose Products .....	165
Fasteners & Installation Tools .....	166-181
SnapRite System .....	170
Pres-N-Snap Installation Tool .....	175
Shock Cord Accessories.....	180
Adhesive-Backed Fasteners .....	181
Webbing Sliders .....	181
Beauchlip Panel Mounting System.....	182
Hooks .....	182
Clips .....	183
Buckles & Webbing Hardware.....	183
Awning Track.....	184
Curtain Track & Hardware .....	185-187
Frame Hardware .....	188-189
Tubing .....	190
Boat Hardware .....	191
Staplers .....	192
Glue Gun .....	192
Lifeline Kits & Hardware .....	193
Furling & Reefing .....	194
Lazy Jack Systems.....	195
Winchrite ABT.....	195
Grommets.....	196
Grommet Setting Tools .....	197
Grommet Kits.....	198
Headboards .....	198
Tool Kits .....	199
Strut & Grabrail Kits.....	200
Rings .....	201
Slugs, Slides & Shackles .....	202-204
Blocks .....	205-207
Eyestraps.....	207
Folding Padeyes.....	208
Cleats .....	208-209
Rigging Shackles .....	210-211
Battens .....	212-213
Jib Sail Attachments .....	214
Thimbles.....	215
Fenders & Buoys.....	216-217

## CORDAGE

Rope .....	218-221
Splicing Tools .....	222
Micro Marine Ratchet.....	222
Leech Line.....	222
Wire Rope .....	222
Shock Cord .....	222
Awning Rope.....	223

## KITS

Custom Sail Kits .....	225
Do-it-Yourself Books .....	226
Spinnaker Sock Kits .....	227
Furling & Reefing Kits .....	228
Sacrificial Sail Sun Cover Kits .....	229
Throated Sail Covers.....	230
Sail Pack Kits.....	231
Bimini Kits.....	232-233
Dodger Kits .....	234-235
1-Bow Replacement Frames .....	235
Anchor Riding Sail Kit.....	236
Hatch Canopy Kit .....	236
Binnacle Wheel Cover Kits .....	236
Foredeck Bag Kits .....	237
Rectangular Sail Covers.....	237
Bag Kits .....	238
Canvas & Sailmaking Books .....	239
Cover Kits.....	240
Bosun's Chair & Mastclimber Kits.....	241
Series Drogue Kits.....	242-243
Safety Tether Kits .....	244
Flag Kits.....	244

## APPENDIX

Thread & Needle Recommendations.....	245
Recommended Thread Colors for Sunbrella.....	246-247
Fastener Tool Selection Guide .....	248-249
Rope Size & Selection Recommendations.....	250
Choosing the Correct Line .....	250
Sail Hardware Compatibility Chart .....	251
Index.....	252-256
Shipping, Ordering & Payment Information .....	256-257

### SEE WHAT'S NEW THIS YEAR!

Sunbrella Makers Collection .....	48
W-1 Hand Press .....	72
Evolution Block-It Fabric .....	90
Sailrite Blade Foam Cutter .....	91
Ultrafeed Industrial Tables .....	108
Top Notch 9 Polyester Bias Binding .....	144
Felt Polyester 1-1/4" Binding .....	144
Surface Mount Disk Hooks .....	151
YKK Colored Zippers .....	157
Zipper Sliders .....	160
AAT-390 Marine & Exterior Adhesive .....	163
Cleaning Buckets and Detailing Kit .....	164
Twist-Lock Driver Installation Tool .....	174
Loxx® Fasteners .....	178
Vent Grommets & Die Sets .....	196
Stainless Steel Rigid Support Strut Kits .....	200
Fenders & Buoys .....	216
Bimini Frame & Skin Kits .....	232
Dodger Frame & Skin Kits .....	234

#### Added Colors!

Ultrasuede Fabric .....	73
Phifertex Plus .....	75
Tenara Thread.....	129
Polypropylene Webbing .....	149
Sunbrella Acrylic Binding .....	141
Morbern Seabrook Vinyl Piping .....	147

# Bring Your DIY to Shore

Our annual home catalog is bursting with fabrics and notions for your home interior or outdoor living spaces. Request your free copy today at [Sailrite.com/catalog-request](http://Sailrite.com/catalog-request).



## FABRIC ICONS

Use these icons to quickly identify what projects are recommended for each fabric



### ALL-SEASON

Allsport  
Boat Blanket  
Brun-Tuff Vinyl  
Chilewich  
Cotton Duck- Marine Finished  
Evolution  
Geobella  
Herculite Riviera  
Infinity  
Marine Topping  
Morbern Hexx & Shock  
Morbern Seabrook Channeling  
Naugahyde All-American  
Naugahyde Universal  
Odyssey  
Seabrook Vinyl  
SeaMark  
Shelter-Rite  
Softouch  
Stamoid  
Sunbrella Marine  
Sunbrella Plus  
Sunbrella Supreme  
Sunbrella Unity  
Sunbrella Upholstery  
Sur Last  
Targa Premium Canopy  
Tonneau Cover  
Top Gun  
Top Gun 1S  
Top Notch 9  
Weblon Regatta



### PROTECTIVE COVERS

Brun-Tuff Vinyl  
Cotton Duck- Marine Finished  
Evolution  
Herculite Riviera  
Marine Topping  
Odyssey  
SeaMark  
Shelter-Rite  
Softouch  
Stamoid  
Sunbrella Marine  
Sur Last  
Tonneau Cover  
Top Gun  
Top Gun 1S  
Top Notch 9  
Weblon Regatta



### OUTDOOR

Allsport  
Boat Blanket  
Brun-Tuff Vinyl  
Chilewich  
Cotton Duck- Marine Finished  
Evolution  
Geobella  
Herculite Riviera  
Infinity  
Marine Topping  
Morbern Hexx & Shock  
Morbern Seabrook Channeling  
Naugahyde All-American  
Naugahyde Universal  
Odyssey  
Phifertex  
Phifertex Plus  
Seabrook Vinyl  
SeaMark  
Shelter-Rite  
Softouch  
Stamoid  
Sunbrella Marine  
Sunbrella Plus  
Sunbrella Supreme  
Sunbrella Unity  
Sunbrella Upholstery  
Sur Last  
Targa Premium Canopy  
Tonneau Cover  
Top Gun  
Top Gun 1S  
Top Notch 9  
Weblon Regatta



### INDOOR

Allsport  
Chilewich  
Foam Backed Headliner  
Geobella  
Hull Blanket Headliner/Hull Liner  
Infinity  
Morbern Hexx & Shock  
Naugahyde Nauga Soft  
Phifertex  
Phifertex Plus  
Softouch  
Sunbrella Upholstery  
Sunforger Car Cover  
Ultrasuede HP



### MARINE

Allsport  
Boat Blanket  
Chilewich  
Cotton Duck- Marine Finished  
Foam-Backed Headliner  
Geobella  
Herculite Riviera  
Hull Blanket Headliner/Hull Liner  
Infinity  
Marine Topping  
Morbern Hexx & Shock  
Morbern Seabrook Channeling  
Naugahyde All-American  
Naugahyde Universal  
Odyssey  
Phifertex  
Phifertex Plus  
Seabrook Vinyl  
SeaMark  
Shelter-Rite  
Softouch  
Stamoid  
Sunbrella Marine  
Sunbrella Plus  
Sunbrella Supreme  
Sunbrella Upholstery  
Sur Last  
Targa Premium Canopy  
Top Gun  
Top Gun 1S  
Top Notch 9  
Ultrasuede HP  
Weblon Regatta



### UPHOLSTERY

Allsport  
Brisa  
Brisa Outdoor  
Geobella  
Morbern Hexx & Shock  
Naugahyde Nauga Soft  
Sunbrella Upholstery  
Ultrasuede HP



### PATIO UMBRELLAS

Sunbrella Unity  
Sunbrella Upholstery



### PILLOWS

Geobella  
Sunbrella Upholstery



### SHADES & BLINDS

Phifertex  
Phifertex Plus



### SLING CHAIRS

Phifertex  
Phifertex Plus



### AWNINGS

Phifertex  
Phifertex Plus  
SeaMark  
Sunbrella Marine  
Sunbrella Plus  
Sunbrella Unity  
Targa Premium Canopy  
Top Notch 9



### CURTAINS/DRAPERIES

Sunbrella Upholstery



### FLOORING

Chilewich  
Infinity



### CUSHIONS

Geobella  
Morbern Hexx & Shock  
Morbern Seabrook Channeling  
Naugahyde All-American  
Naugahyde Universal  
Phifertex  
Phifertex Plus  
Seabrook Vinyl  
SeaMark  
Sunbrella Marine  
Sunbrella Upholstery  
Ultrasuede HP

## FABRIC SAMPLES

Most samples are either 4" x 4" or 6" x 6". Samples of striped fabrics are approximately 2" x 12". Therefore, samples may not show all of the colors or pattern in a fabric. To see full colors and repeats, we suggest ordering a yard of fabric.

### ORDERING

**Step 1:** Find the fabric you like at [Sailrite.com](http://Sailrite.com)

**Step 2:** If a sample is available, there will be an "Order Sample" located under the 'Add to Cart' button

**PLEASE NOTE:** We do our best to display fabric colors and textures as accurately as possible, but we cannot guarantee 100% accuracy. We recommend ordering a sample swatch before making a final purchase. Samples may not show all the colors or patterns of a fabric, to see a full color sampling, order a full yard.





Sunbrella is all about quality. Every Sunbrella fiber is guaranteed to be:

### 100% Solution-dyed

While other fabrics are just dyed on the surface, Sunbrella fabrics are solution-dyed, which means the color runs to the core of every fiber so it won't fade or wash out.

### UV & Fade Resistant

Sunbrella fabrics stand up to even the harshest tropical conditions. Backed by a 5-10 year warranty, they will not degrade or fade in the sun.

### Water Resistant & Breathable

A great choice for covers, Sunbrella's water resistance protects from the elements while remaining breathable to prevent the growth of mold and mildew.

### Stain & Mildew Resistant

Well suited for a life outdoors, Sunbrella won't stain, is easy to clean and is resistant to mold and mildew growth. With regular cleaning, Sunbrella will look good as new for years to come.

### Shrink-proof & Stretch-free

Skip covers that sag. Sunbrella won't noticeably shrink or stretch so your covers will keep their taut fit.

## *A Stylish Performance Fabric for Every Aspect of Your Life*

*Offering the best in marine, awning and upholstery fabrics, Sunbrella makes every fabric in your life worry-free.*

# SUNBRELLA® MARINE FABRIC

## BY GLEN RAVEN

Sunbrella is the premier performance fabric collection and standard cover cloth for the boating and awning industries. With its legendary combination of durability, water resistance, breathability, and beautiful style, Sunbrella fabric is the perfect canvas for shading on land or at sea. With a 10 year limited warranty, there is no better outdoor fabric!

**SEWING:** See Thread & Needle Recommendations on p.245 **MATERIAL:** 100% solution-dyed acrylic **WIDTH:** A 46" B 60"  
**WEIGHT:** 9 oz. per square yard **WARRANTY:** 10 year limited **SALE UNIT:** Sold per linear yard

**RECOMMENDED FOR:**



Awnings, dodgers, biminis, sun bands, boat tops, sail covers, other outdoor covers, outdoor furniture, cockpit cushions, and enclosure curtains



**LOGO RED P**  
A #4666-0000 \$25.95/YD ~~\$18.95/YD\*~~  
B #6066-0000 \$29.95/YD ~~\$21.95/YD\*~~



**JOCKEY RED P**  
A #4603-0000 \$25.95/YD ~~\$18.95/YD\*~~  
B #6003-0000 \$29.95/YD ~~\$21.95/YD\*~~



**DUBONNET TWEED**  
A #4606-0000 \$22.95/YD ~~\$16.95/YD\*~~  
B #6006-0000 \$25.95/YD ~~\$19.95/YD\*~~



**TRESCO BRICK P**  
A #4699-0000 \$25.95/YD ~~\$18.95/YD\*~~



**BURGUNDY P**  
A #4631-0000 \$25.95/YD ~~\$18.95/YD\*~~  
B #6031-0000 \$29.95/YD ~~\$21.95/YD\*~~



**TERRACOTTA**  
A #4622-0000 \$22.95/YD ~~\$16.95/YD\*~~



**TRESCO CLAY P**  
A #4698-0000 \$23.95/YD ~~\$18.95/YD\*~~

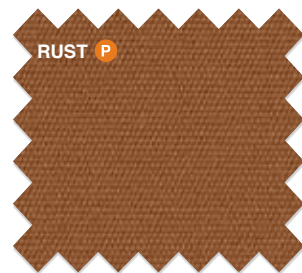

**RUST P**  
A #4689-0000 \$25.95/YD ~~\$18.95/YD\*~~



**TUSCAN P**  
A #4677-0000 \$25.95/YD ~~\$18.95/YD\*~~



**ORANGE P**  
A #4609-0000 \$25.95/YD ~~\$18.95/YD\*~~



**SUNFLOWER P YELLOW**  
A #4602-0000 \$25.95/YD ~~\$18.95/YD\*~~  
B #6002-0000 \$29.95/YD ~~\$21.95/YD\*~~

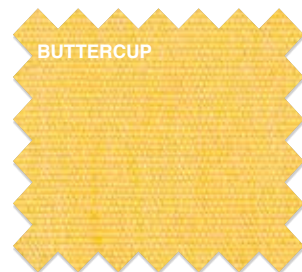

**BUTTERCUP**  
A #4635-0000 \$22.95/YD ~~\$16.95/YD\*~~



**GINKGO**  
A #4685-0000 \$22.95/YD ~~\$16.95/YD\*~~



**BASIL**  
A #4688-0000 \$22.95/YD ~~\$16.95/YD\*~~

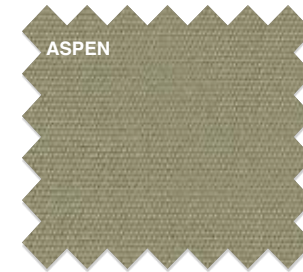

**ASPEN**  
A #4668-0000 \$22.95/YD ~~\$16.95/YD\*~~



**FERN**  
A #4671-0000 \$22.95/YD ~~\$16.95/YD\*~~



**SILICA SAGE P**  
A #4896-0000 \$25.95/YD ~~\$18.95/YD\*~~



**IVY**  
A #4632-0000 \$22.95/YD ~~\$16.95/YD\*~~  
B #6032-0000 \$25.95/YD ~~\$19.95/YD\*~~



**FOREST GREEN**  
A #4637-0000 \$22.95/YD ~~\$16.95/YD\*~~  
B #6037-0000 \$25.95/YD ~~\$19.95/YD\*~~



**HEMLOCK TWEED**  
A #4605-0000 \$22.95/YD ~~\$16.95/YD\*~~  
B #6005-0000 \$25.95/YD ~~\$19.95/YD\*~~



**ERIN GREEN**  
A #4600-0000 \$22.95/YD ~~\$16.95/YD\*~~



**SEAGRASS GREEN**  
A #4645-0000 \$22.95/YD ~~\$16.95/YD\*~~



**PERSIAN GREEN**  
A #4643-0000 \$22.95/YD ~~\$16.95/YD\*~~  
B #6043-0000 \$25.95/YD ~~\$19.95/YD\*~~

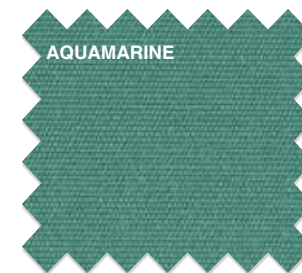

**AQUAMARINE**  
A #4623-0000 \$22.95/YD ~~\$16.95/YD\*~~  
B #6023-0000 \$25.95/YD ~~\$19.95/YD\*~~



**TURQUOISE**  
A #4610-0000 \$22.95/YD ~~\$16.95/YD\*~~  
B #6010-0000 \$25.95/YD ~~\$19.95/YD\*~~

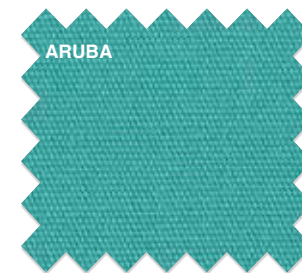

**ARUBA**  
A #4612-0000 \$22.95/YD ~~\$16.95/YD\*~~  
B #6012-0000 \$25.95/YD ~~\$19.95/YD\*~~



**SPA**  
A #4673-0000 \$22.95/YD ~~\$16.95/YD\*~~  
B #6073-0000 \$25.95/YD ~~\$19.95/YD\*~~



**SEA**  
A #4664-0000 \$22.95/YD ~~\$16.95/YD\*~~

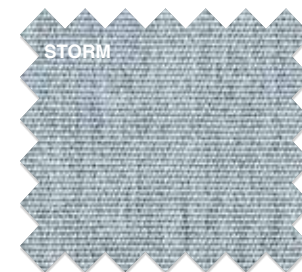

**STORM**  
A #4636-0000 \$22.95/YD ~~\$16.95/YD\*~~



**SAPPHIRE BLUE**  
A #4641-0000 \$22.95/YD ~~\$16.95/YD\*~~



**SKY BLUE**  
A #4624-0000 \$22.95/YD ~~\$16.95/YD\*~~  
B #6024-0000 \$25.95/YD ~~\$19.95/YD\*~~

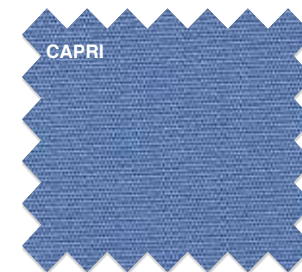

**CAPRI**  
A #4675-0000 \$22.95/YD ~~\$16.95/YD\*~~  
B #6075-0000 \$25.95/YD ~~\$19.95/YD\*~~

► [Need a Sample?](#) (details p.11) | Find information on our helpful fabric resources on p.17



# SUNBRELLA® MARINE

Width: A 46" B 60"

Details p.14



**SILICA CARIBBEAN** <sup>P</sup>  
A #4831-0000 \$25.95/YD ~~\$18.95/YD\*~~

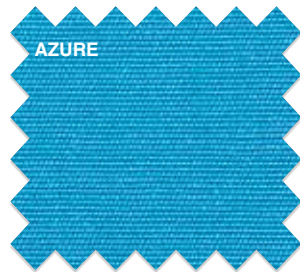

**AZURE**  
A #4669-0000 \$22.95/YD ~~\$16.95/YD\*~~  
B #6069-0000 \$25.95/YD ~~\$19.95/YD\*~~



**PACIFIC BLUE**  
A #4601-0000 \$22.95/YD ~~\$16.95/YD\*~~  
B #6001-0000 \$25.95/YD ~~\$19.95/YD\*~~



**MEDITERRANEAN BLUE**  
A #4652-0000 \$22.95/YD ~~\$16.95/YD\*~~  
B #6052-0000 \$25.95/YD ~~\$19.95/YD\*~~



**ROYAL BLUE TWEED**  
A #4617-0000 \$22.95/YD ~~\$16.95/YD\*~~  
B #6017-0000 \$25.95/YD ~~\$19.95/YD\*~~

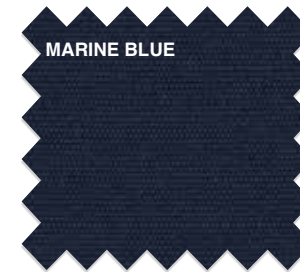

**MARINE BLUE**  
A #4678-0000 \$22.95/YD ~~\$16.95/YD\*~~  
B #6078-0000 \$25.95/YD ~~\$19.95/YD\*~~



**CAPTAIN NAVY**  
A #4646-0000 \$22.95/YD ~~\$16.95/YD\*~~  
B #6046-0000 \$25.95/YD ~~\$19.95/YD\*~~



**OCEAN BLUE**  
A #4679-0000 \$22.95/YD ~~\$16.95/YD\*~~  
B #6079-0000 \$25.95/YD ~~\$19.95/YD\*~~



**MEDITERRANEAN TWEED**  
A #4653-0000 \$22.95/YD ~~\$16.95/YD\*~~  
B #6053-0000 \$25.95/YD ~~\$19.95/YD\*~~



**NAVY**  
A #4626-0000 \$22.95/YD ~~\$16.95/YD\*~~  
B #6026-0000 \$25.95/YD ~~\$19.95/YD\*~~



**CONCORD** <sup>P</sup>  
A #4665-0000 \$25.95/YD ~~\$18.95/YD\*~~  
B #6065-0000 \$29.95/YD ~~\$21.95/YD\*~~

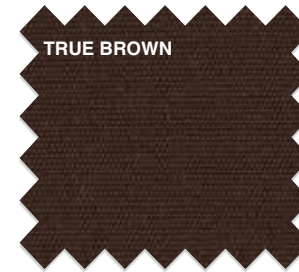

**TRUE BROWN**  
A #4621-0000 \$22.95/YD ~~\$16.95/YD\*~~  
B #6021-0000 \$25.95/YD ~~\$19.95/YD\*~~



**WALNUT BROWN TWEED**  
A #4618-0000 \$22.95/YD ~~\$16.95/YD\*~~



**BLACK CHERRY**  
A #4640-0000 \$22.95/YD ~~\$16.95/YD\*~~

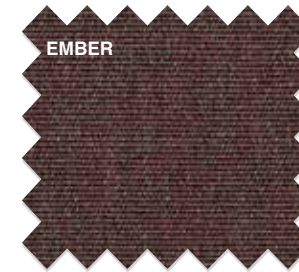

**EMBER**  
A #4659-0000 \$22.95/YD ~~\$16.95/YD\*~~



**MAHOGANY**  
A #4667-0000 \$22.95/YD ~~\$16.95/YD\*~~

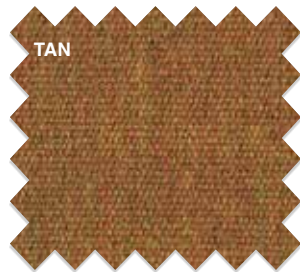

**TAN**  
A #4614-0000 \$22.95/YD ~~\$16.95/YD\*~~



**COCOA**  
A #4676-0000 \$22.95/YD ~~\$16.95/YD\*~~



**MOCHA TWEED**  
A #4616-0000 \$22.95/YD ~~\$16.95/YD\*~~



**TRESCO BRASS**  
A #4658-0000 \$22.95/YD ~~\$16.95/YD\*~~



**TOAST**  
A #4628-0000 \$22.95/YD ~~\$16.95/YD\*~~  
B #6028-0000 \$25.95/YD ~~\$19.95/YD\*~~



**WHEAT**  
A #4674-0000 \$22.95/YD ~~\$16.95/YD\*~~  
B #6074-0000 \$25.95/YD ~~\$19.95/YD\*~~



**SILICA BARLEY** <sup>P</sup>  
A #4858-0000 \$25.95/YD ~~\$18.95/YD\*~~



**LINEN TWEED**  
A #4654-0000 \$22.95/YD ~~\$16.95/YD\*~~  
B #6054-0000 \$25.95/YD ~~\$19.95/YD\*~~



**TRESCO LINEN**  
A #4695-0000 \$22.95/YD ~~\$16.95/YD\*~~  
B #6095-0000 \$25.95/YD ~~\$19.95/YD\*~~



**BEIGE**  
A #4620-0000 \$22.95/YD ~~\$16.95/YD\*~~  
B #6020-0000 \$25.95/YD ~~\$19.95/YD\*~~



**SILICA SESAME** <sup>P</sup>  
A #4860-0000 \$25.95/YD ~~\$18.95/YD\*~~



**TRESCO BIRCH**  
A #4696-0000 \$22.95/YD ~~\$16.95/YD\*~~



**HEATHER BEIGE**  
A #4672-0000 \$22.95/YD ~~\$16.95/YD\*~~  
B #6072-0000 \$25.95/YD ~~\$19.95/YD\*~~



**SILICA DUNE** <sup>P</sup>  
A #4859-0000 \$25.95/YD ~~\$18.95/YD\*~~

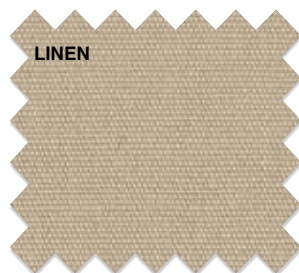

**LINEN**  
A #4633-0000 \$22.95/YD ~~\$16.95/YD\*~~  
B #6033-0000 \$25.95/YD ~~\$19.95/YD\*~~

► Need a Sample? (details p.11) | Find information on our helpful fabric resources on p.17

<sup>P</sup> Premium Sunbrella Color

## Find More Fabric Information at Sailrite.com

### SUNBRELLA CLEANING INSTRUCTIONS

Recommended cleaning, stain removal, and maintenance instructions. Find these specifications as a related document under any Sunbrella fabric at [Sailrite.com](http://Sailrite.com).

### OUTDOOR FABRIC SELECTION GUIDE

Ranks outdoor fabrics on breathability, water resistance, abrasion resistance, UV resistance, colorfastness, and cleanability. Find these specifications as a related document under any outdoor fabric at [Sailrite.com](http://Sailrite.com).

### THREAD & NEEDLE RECOMMENDATIONS p.245

Quickly identify the best thread or needle type for different fabrics.



# SUNBRELLA® MARINE

Width: A 46" B 60"

Details p.14



A #4634-0000 \$22.95/YD \$16.95/YD\*  
B #6034-0000 \$25.95/YD \$19.95/YD\*



A #4630-0000 \$22.95/YD \$16.95/YD\*  
B #6030-0000 \$25.95/YD \$19.95/YD\*



A #4644-0000 \$22.95/YD \$16.95/YD\*  
B #6044-0000 \$25.95/YD \$19.95/YD\*



A #4684-0000 \$22.95/YD \$16.95/YD\*

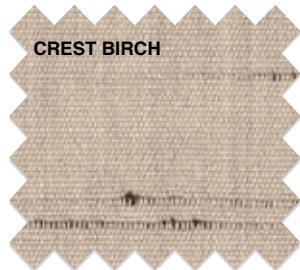

A #4660-0000 \$25.95/YD \$16.95/YD\*



A #4642-0000 \$22.95/YD \$16.95/YD\*  
B #6042-0000 \$25.95/YD \$19.95/YD\*



A #4651-0000 \$22.95/YD \$16.95/YD\*  
B #6051-0000 \$25.95/YD \$19.95/YD\*



A #4897-0000 \$25.95/YD \$18.95/YD\*



A #4607-0000 \$22.95/YD \$16.95/YD\*  
B #6007-0000 \$25.95/YD \$19.95/YD\*



A #4683-0000 \$22.95/YD \$16.95/YD\*  
B #6083-0000 \$25.95/YD \$19.95/YD\*



A #4862-0000 \$25.95/YD \$18.95/YD\*



A #4833-0000 \$25.95/YD \$18.95/YD\*



A #4861-0000 \$25.95/YD \$18.95/YD\*

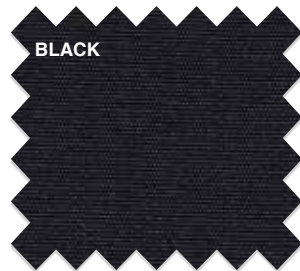

A #4608-0000 \$22.95/YD \$16.95/YD\*  
B #6008-0000 \$25.95/YD \$19.95/YD\*



A #4604-0000 \$22.95/YD \$16.95/YD\*  
B #6004-0000 \$25.95/YD \$19.95/YD\*

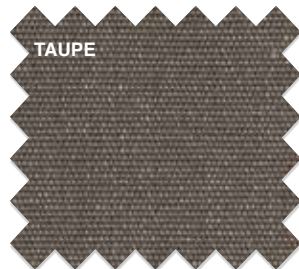

A #4648-0000 \$22.95/YD \$16.95/YD\*  
B #6048-0000 \$25.95/YD \$19.95/YD\*



A #4662-0000 \$25.95/YD \$16.95/YD\*



A #4615-0000 \$22.95/YD \$16.95/YD\*



# SUNBRELLA® PLUS

Traditional Sunbrella marine and awning/shade fabric with a durable polyurethane undercoating for even more moisture and abrasion resistance. Use coated side down.

SEWING: See Thread & Needle Recommendations on p.245

MATERIAL: 100% solution-dyed acrylic WIDTH: 60"

WEIGHT: 10 oz. per square yard WARRANTY: 5 year limited

SALE UNIT: Sold per linear yard

RECOMMENDED FOR: Awnings, dodgers, biminis, boat tops and enclosure curtains



#8404-0000 \$33.95/YD \$26.95/YD\*

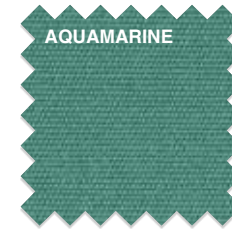

#8423-0000 \$33.95/YD \$26.95/YD\*



#8479-0000 \$33.95/YD \$26.95/YD\*



#8442-0000 \$33.95/YD \$26.95/YD\*



#8406-0000 \$33.95/YD \$26.95/YD\*



#8437-0000 \$33.95/YD \$26.95/YD\*



#8430-0000 \$33.95/YD \$26.95/YD\*



#8431-0000 \$36.95/YD \$28.95/YD\*



#8417-0000 \$33.95/YD \$26.95/YD\*



#8428-0000 \$33.95/YD \$26.95/YD\*



#8443-0000 \$33.95/YD \$26.95/YD\*



#8446-0000 \$33.95/YD \$26.95/YD\*



#8403-0000 \$36.95/YD \$28.95/YD\*



#8401-0000 \$33.95/YD \$26.95/YD\*

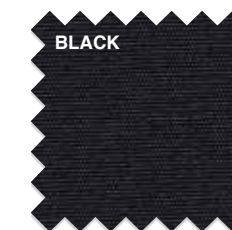

#8408-0000 \$33.95/YD \$26.95/YD\*

► Need a Sample? (details p.11) | Find information on our helpful fabric resources on p.17

P Premium Sunbrella Color



# SUNBRELLA® SUPREME

Luxurious, waterproof exterior marine fabric featuring traditional Sunbrella marine and awning/shade fabric and a special acrylic flocking. The unique bonding process creates an “essentially waterproof” yet breathable Sunbrella canvas with a beautiful soft headliner underneath. Safe to use against varnish. Use flocking side down.

**MATERIAL:** 100% solution-dyed acrylic  
**WIDTH:** 60"  
**WEIGHT:** 12.5 oz. per square yard  
**WARRANTY:** 5 year limited  
**SALE UNIT:** Sold per linear yard

**RECOMMENDED FOR:**



Boat tops, biminis, dodgers and enclosures



# SUNBRELLA® UNITY

Get a vintage look without sacrificing quality! Sunbrella Unity fabrics are created with 50% recycled Sunbrella fiber and 50% new Sunbrella fibers. The result is a decorative shade fabric with distinctive vintage charm.

**MATERIAL:** 100% solution-dyed acrylic  
**WIDTH:** 60"  
**WEIGHT:** 12 oz. per square yard  
**WARRANTY:** 5 year limited  
**SALE UNIT:** Sold per linear yard

**RECOMMENDED FOR:**



Fixed and retractable awnings, sail shades, umbrellas



### RENAISSANCE FABRICS

Sunbrella Renaissance fabrics combine post-industrial recycled Sunbrella fiber with virgin Sunbrella fiber for vintage charm, rich coloration, and a soft feel.

► [Need a Sample?](#) (details p.11) | Find information on our helpful fabric resources on p.17

## A Sailrite Favorite!

Top Notch 9 is easy to sew and has great durability. That's why we think it's the best solution-dyed polyester available!



# TOP NOTCH 9 BY MARLEN TEXTILES

A breathable, water repellent cover fabric, Top Notch 9 is made from 100% solution-dyed polyester with a fluorocarbon finish. It also boasts high tear strength, abrasion resistance, color fastness and UV resistance. With excellent dimensional stability, Top Notch 9 will not noticeably shrink, stretch or sag.

**RECOMMENDED FOR:**



Awnings, dodgers, biminis, sacrificial sail covers, boat tops, boat covers, sail covers, cockpit cushions and enclosure curtains.

**SEWING:** See Thread & Needle Recommendations p.245

**MATERIAL:** Solution-dyed polyester  
**WIDTH:** 60"  
**WEIGHT:** 9 oz. per square yard  
**WARRANTY:** 8 year limited  
**SALE UNIT:** Sold per linear yard

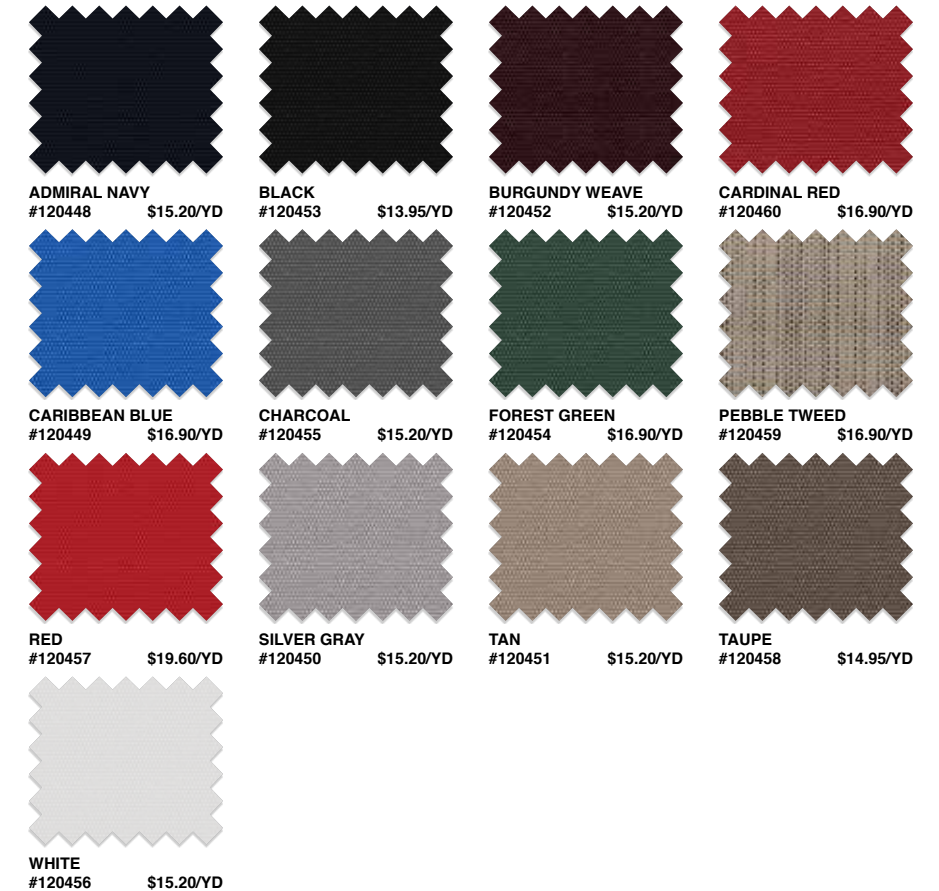

► [Need a Sample?](#) (details p.11) | Find information on our helpful fabric resources on p.17



## SEAMARK BY HAARTZ & GLEN RAVEN FABRICS

Combine the premier Sunbrella® woven acrylic with a Haartz textured marine-grade vinyl backing for one tough, waterproof, UV resistant marine fabric! Engineered to endure salt, moisture, sun, wind, and temperature extremes. Superior seam and tensile strength. Di-electrically sealable. Use coated side down.

- A** 1-24 yards **\$28.95/YD**  
25-49 yards **\$26.92/YD**  
50+ yards **\$25.19/YD**
- B** 1-24 yards **\$31.95/YD**  
25-49 yards **\$29.71/YD**  
50+ yards **\$27.80/YD**
- C** 1-24 yards **\$34.95/YD**  
25-49 yards **\$32.50/YD**  
50+ yards **\$30.41/YD**

### RECOMMENDED FOR:



Convertible and boat tops, dodgers, biminis, awnings, tonneau covers, and cockpit cushions

**SEWING:** See Thread & Needle Recommendations p.245

**MATERIAL:** 100% solution-dyed acrylic, vinyl back

**WIDTH:** 60"

**WEIGHT:** 15.6 oz. per square yard

**WARRANTY:** 5 year limited

**SALE UNIT:** Sold per linear yard

\*Color does not match standard Sunbrella® Toast.

► [Need a Sample?](#) (details p.11) | Find information on our helpful fabric resources on p.17



## WEBLON REGATTA BY HERCULITE

Protect your boat (and yourself!) from the elements with this waterproof vinyl-laminated polyester fabric. With extreme strength, abrasion resistance, and multi-directional stretch resistance (including bias), Regatta allows for superior contouring around frames to ensure a tight waterproof fit. Exclusive Rain Kleen® finish (top side) prolongs the life and color of the fabric. Mildew and chemical resistant. Cleans with mild soap and water.

\$16.95/YD

### RECOMMENDED FOR:



Boat covers, boom awnings, dodgers, biminis, convertible tops, enclosures, and protective covers

**SEWING:** See Thread & Needle Recommendations p.245

**MATERIAL:** Vinyl-laminated polyester

**WIDTH:** 62"

**WEIGHT:** 13 oz. per square yard

**SALE UNIT:** Sold per linear yard

CREATE A CLEAN, FINISHED EDGE ON YOUR PROJECTS WITH MATCHING WEBLON BINDING. P.142



## HERCULITE RIVIERA

Provide the ultimate protection for you and your boat with Herculite Riviera Vinyl Fabric. A lightweight, waterproof, vinyl-laminated polyester, Riviera features the best dimensional stability and stretch resistance for taut, wrinkle-free covers and tops. This premium vinyl has a beautiful finish that cleans better than similar vinyls. Soft and supple hand for easy fabrication as well as excellent durability, abrasion resistance, and UV, mildew, heat, cold and chemical resistance. Cleans easily with mild soap and water. **\$21.95/YD**

### RECOMMENDED FOR



Boat covers, boom awnings, biminis, convertible tops, dodgers, enclosures, cushions and protective covers.

**SEWING:** See Thread & Needle Recommendations p.245

**MATERIAL:** Vinyl-laminated polyester

**WIDTH:** 62"

**WEIGHT:** 12.5 oz. per square yard

**SALE UNIT:** Sold per linear yard

► [Need a Sample?](#) (details p.11) | Find information on our helpful fabric resources on p.17





## STAMOID BY FERRARI TEXTILES

Popular vinyl on yachts! Completely waterproof vinyl-coated woven polyester with good tensile strength and outstanding UV resistance. Unlike many marine fabrics, Stamoid has almost zero shrinkage (less than 0.5%) and does not expand or have humidity sagging problems. Dirt repellent and treated against mildew for an easy to clean, washable, outdoor fabric. Easy to fold and stow. May require venting. Up to 10 year life expectancy.

**A** 8.82 oz. Stamoid Light (One side vinyl-coated. Must be used with the lightly textured, coated side facing out and the heavily textured, woven side facing in)

1-19 yards **\$25.95/YD** | 20-53 yards **\$23.36/YD** | 54+ yards **\$22.06/YD**

**B** 12.64 oz. Stamoid Top (Both sides vinyl-coated. Use with the lightly textured side facing out and the smooth, shiny side facing in)

1-19 yards **\$29.95/YD** | 20-53 yards **\$26.96/YD** | 54+ yards **\$25.46/YD**

### RECOMMENDED FOR:



Dodgers, biminis, boat tops, boat awnings, enclosure curtains, and architectural structures

**SEWING:** See Thread & Needle Recommendations p.245

**MATERIAL:** Vinyl-coated woven polyester

**WIDTH:** 59"

**WARRANTY:** 5 year limited

**SALE UNIT:** Sold per linear yard

<b>SNOW WHITE</b> A #5912921 B #5912925	<b>WHITE</b> A #5911304 B #5911638	<b>CREAM</b> A #5912515 B #5912518	<b>IVORY</b> A #5911747 B #5912284
<b>SAND</b> A #5911400 B #120703	<b>DESERT</b> A #120711 B #120702	<b>TAUPE</b> B #120704	<b>BORDEAUX</b> A #120712 B #120705
<b>ROYAL BLUE</b> A #5911534 B #120709	<b>NAVY</b> A #5912592 B #5912629	<b>EVERGREEN</b> A #120714 B #120708	<b>PEARL GRAY</b> A #5912249 B #5912285
<b>CLOUD GREY</b> A #120713 B #120706	<b>CHARCOAL</b> B #120707	<b>BLACK</b> A #120715 B #103079	 <b>IMAR STAMOID CLEANERS</b> p.164

## TOP GUN BY MARLEN TEXTILES

Unmatched in abrasion resistance and durability, Top Gun is a high count woven polyester duck with outstanding tensile and tear strength, puncture resistance, dimensional stability, and minimal shrink or stretch. A special acrylic coating prevents hardening, cracking or peeling and adds increased UV, mildew, and water resistance. 5–10 year life expectancy.

### RECOMMENDED FOR:



Protective covers, trawling covers, biminis and dodgers

**SEWING:** See Thread & Needle Recommendations p.245

**MATERIAL:** Woven polyester

**WIDTH:** 62"

**WEIGHT:** 11.5 oz. per sq yard

**WARRANTY:** 5 year limited

**SALE UNIT:** Sold per linear yard

 <b>AQUAMARINE</b> #120389 \$19.00/YD	 <b>TEAL</b> #120390 \$19.00/YD	 <b>FOREST GREEN</b> #120392 \$19.00/YD	 <b>TURQUOISE</b> #120391 \$19.00/YD
 <b>HARBOR BLUE</b> #120394 \$19.00/YD	 <b>ROYAL BLUE</b> #120393 \$19.75/YD	 <b>NAVY BLUE</b> #120395 \$19.00/YD	 <b>CARIBBEAN BLUE</b> #792100 \$19.00/YD
 <b>BIRCH</b> #120398 \$19.00/YD	 <b>SAND</b> #120399 \$19.00/YD	 <b>BUCKSKIN TAN</b> #120400 \$19.00/YD	 <b>HEMP BEIGE</b> #120401 \$19.00/YD
 <b>TAUPE</b> #120402 \$19.00/YD	 <b>CHOCOLATE BROWN</b> #120403 \$19.00/YD	 <b>SEAGULL GRAY</b> #102887 \$19.00/YD	 <b>CHARCOAL</b> #120396 \$19.00/YD
 <b>ONYX BLACK</b> #120397 \$19.00/YD	 <b>SUNSET RED</b> #120404 \$19.75/YD	 <b>BURGUNDY</b> #120405 \$19.75/YD	 <b>ARCTIC WHITE</b> #796100 \$19.00/YD

► [Need a Sample?](#) (details p.11) | Find information on our helpful fabric resources on p.17

► [Need a Sample?](#) (details p.11) | Find information on our helpful fabric resources on p.17



## MARINE TOPPING

Waterproof off-white vinyl-coated polyester/cotton fabric with charcoal denim back for bimini tops and covers on pontoon and power boats. UV and mildew resistant with high tear and tensile strength. 5–10 year life expectancy. Kid embossed.

Off White/Denim Lining **#821100 \$13.95/YD**

### RECOMMENDED FOR:

Bimini tops and covers on pontoon and power boats

**SEWING:** See Thread & Needle Recommendations p.245

**MATERIAL:** Vinyl-coated poly/cotton, denim back

**WIDTH:** 54"

**WEIGHT:** 24 oz. per square yard

**FIRE RATING:** MVSS-302

**SALE UNIT:** Sold per linear yard

## BRUN-TUFF CAMO OLIVE DRAB VINYL

A vinyl-reinforced polyester that is shrink-resistant, low stretch, and long lasting. Combines vinyl and polyester in an innovative construction to create the highest tear and tensile strength available. Waterproof, highly abrasion resistant, flame retardant and heat sealable. Easy to clean and rot resistant. Traditional woodland camouflage.

**#783075 \$9.95/YD**

### RECOMMENDED FOR:

Outdoor covers, tarpaulins, heavy-duty bags and drop cloths

**SEWING:** See Thread & Needle Recommendations p.245

**MATERIAL:** Vinyl-reinforced polyester

**WIDTH:** 54"

**WEIGHT:** 18 oz. per square yard

**REPEAT:** 14" x 17"

**SALE UNIT:** Sold per linear yard

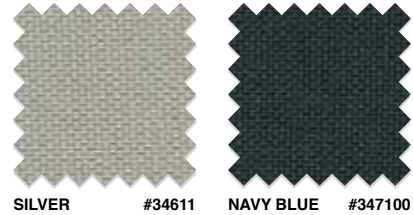

## COTTON DUCK - MARINE FINISHED

Soft marine finished cotton duck with excellent water repellency and mildew resistance. Allow for 3% shrinkage under normal use.

Pearl Gray **#552**      Off White **#863**

1-24 yards **\$8.95/YD**      1-24 yards **\$7.95/YD**

25-99 yards **\$8.50/YD**      25-99 yards **\$7.60/YD**

100+ yards **\$8.05/YD**      100+ yards **\$7.20/YD**

### RECOMMENDED FOR:

Boat covers and boat deck coverings (painted), heavy bags, hats, or floor covering and roofing

**SEWING:** See Thread & Needle Recommendations p.245

**MATERIAL:** Marine finished cotton duck

**WIDTH:** 36"

**WEIGHT:** 10 oz.

**SALE UNIT:** Sold per linear yard

## #8 COTTON DUCK

Double filled, untreated #8 cotton duck with a soft hand and durable quality. Allow for 3% shrinkage under normal use. Natural color.

**#103406**

1-24 yards **\$5.95/YD**

25-99 yards **\$5.65/YD**

100+ yards **\$5.36/YD**

### RECOMMENDED FOR:

Heavy bags, water buckets, tarps, and tents

**SEWING:** See Thread & Needle Recommendations p.245

**MATERIAL:** Untreated #8 cotton duck

**WIDTH:** 60"

**WEIGHT:** 18 oz. per square yard

**SALE UNIT:** Sold per linear yard

## CORDURA® 1000 NYLON

Heavy-duty 1000 denier woven DuPont nylon with a 1 oz. urethane coating to increase durability, water repellency, and resistance to abrasion, punctures, and tears.

**\$17.95/YD**

### RECOMMENDED FOR:

Heavy-duty bags, soft-sided luggage, horse blankets, backpacks, and recreational equipment

**SEWING:** See Thread & Needle Recommendations p.245

**MATERIAL:** Nylon, urethane coating

**WIDTH:** 60"

**WEIGHT:** 13.5 oz. per square yard

**SALE UNIT:** Sold per linear yard

## TOP GUN 1S BY MARLEN TEXTILES

A durable marine polyester with no color rub off! Top Gun 1S provides excellent water resistance, durability, abrasion resistance and superior tear strength. The underside of the fabric is un-dyed and un-coated so colors won't rub off onto the surface underneath. The topside features an acrylic coating that won't crack, peel or harden and that resists mold, mildew and UV rays.

### RECOMMENDED FOR:



Pontoon, mooring and short-range travel covers, biminis, and t-tops.

**SEWING:** See Thread & Needle Recommendations p.245

**MATERIAL:** Woven polyester

**WIDTH:** 60"

**WEIGHT:** 9 oz. per square yard

**WARRANTY:** 5 year limited

**SALE UNIT:** Sold per linear yard



► [Need a Sample?](#) (details p.11) | Find information on our helpful fabric resources on p.17





**FREE VIDEO: "How to Make a Personal Watercraft Cover"**  
 Watch at [Sailrite.com](http://Sailrite.com) (#X-HT-200524)



## ODYSSEY BY MARLEN TEXTILES

Odyssey fabrics are light weight woven polyester fabric with high strength, dimensional stability, and abrasion, mildew and UV resistance. It is acrylic coated with a clear back coat increasing water resistance. Very low shrink or stretch. There is a top and bottom side (light shine). 3–5 year life expectancy.

### RECOMMENDED FOR:



Bags, boat awnings, and lighter weight covers for boats, dinghies, and grills

**SEWING:** See Thread & Needle Recommendations p.245

**MATERIAL:** Woven polyester with clear coat

**WIDTH:** 64"

**WEIGHT:** 6.5 oz. per square yard

**WARRANTY:** 3 year limited

**SALE UNIT:** Sold per linear yard

 <b>HARBOR BLUE</b> #120413 \$11.60/YD	 <b>ROYAL BLUE</b> #120412 \$11.60/YD	 <b>CARIBBEAN BLUE</b> #802123 \$11.60/YD	 <b>LAKESIDE BLUE</b> #120411 \$11.60/YD
 <b>AQUAMARINE</b> #120406 \$11.60/YD	 <b>TURQUOISE</b> #120408 \$11.60/YD	 <b>TEAL</b> #120407 \$11.60/YD	 <b>FOREST GREEN</b> #120409 \$11.60/YD
 <b>RED</b> #120421 \$12.25/YD	 <b>BURGUNDY</b> #120422 \$12.25/YD	 <b>BROWN</b> #120417 \$11.60/YD	 <b>SAND</b> #120415 \$11.60/YD
 <b>BIRCH</b> #120414 \$11.60/YD	 <b>TAUPE</b> #120416 \$11.60/YD	 <b>SILVER GRAY</b> #120418 \$11.60/YD	 <b>CHARCOAL</b> #120419 \$11.60/YD
 <b>BLACK</b> #120420 \$11.60/YD	 <b>WHITE</b> #803122 \$11.60/YD		

► [Need a Sample?](#) (details p.11) | Find information on our helpful fabric resources on p.17

## SUR LAST® BY GLEN RAVEN

All weather 100% solution-dyed polyester that offers great protection for anything outdoors! With a special urethane coating, Sur Last remains breathable but has increased water and mildew resistance. Excellent tear and abrasion resistance with minimal shrink or stretch. Safe against gel coats. Outstanding silk screen adhesion.

Break strength: Warp 325 lb. / Fill 275 lb.

Tear strength: Warp 40 lb. / Fill 35 lb.

### RECOMMENDED FOR:



Boat, automotive, motorcycle, & PWC covers; storage covers; sail bags; and packs

**SEWING:** See Thread & Needle Recommendations p.245

**MATERIAL:** 100% solution-dyed polyester

**WIDTH:** 60"

**WEIGHT:** 7 oz. per square yard

**WARRANTY:** 3 year limited

**SALE UNIT:** Sold per linear yard

► [Need a Sample?](#) (details p.11) | Find information on our helpful fabric resources on p.17

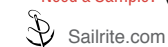

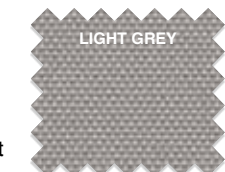
 <b>LIGHT GREY</b> #386200 \$13.95/YD	 <b>SAND</b> #385300 \$13.95/YD	 <b>SCARLET</b> #386900 \$15.95/YD	 <b>FOREST</b> #386000 \$13.95/YD
 <b>BLACK</b> #385400 \$13.95/YD	 <b>NAVY WEAVE</b> #385100 \$13.95/YD	 <b>ADMIRAL NAVY</b> #386600 \$13.95/YD	 <b>WALNUT</b> #387100 \$13.95/YD



**GREAT FOR CHAFE PROTECTION  
PATCHES ON DINGHY CHAPS AND MORE!**  
See Shelter-Rite featured in our Free  
"How to Make Dinghy Chaps" Video.  
Watch at Sailrite.com (#X-HT-200682).

## SOFTOUCH BY MARLEN TEXTILES

A fabric that protects inside and out! Softouch is Odyssey fabric with a felt-like, non-woven backer laminated to the back. It offers great strength and dimensional stability as well as high UV, abrasion and mildew resistance. The fuzzy underside won't scratch so it's safe to use against delicate surfaces or gel coat.

### RECOMMENDED FOR:



Trailing bottom boat covers as well as covers for cockpits, monitor and TV screens, cars, wooden boats, grills, and more

**SEWING:** See Thread & Needle Recommendations p.245

**MATERIAL:** 100% woven polyester top  
100% polyester soft non-woven back

**WIDTH:** 60"

**WEIGHT:** 11 oz. per square yard

**WARRANTY:** 3 year limited

**SALE UNIT:** Sold per linear yard

► [Need a Sample?](#) (details p.11) | Find information on our helpful fabric resources on p.17



**BIRCH**  
#120426 \$19.25/YD



**BLACK**  
#120431 \$19.25/YD

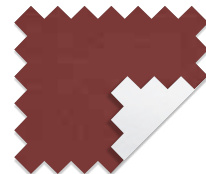

**BURGUNDY**  
#120433 \$20.15/YD



**CARIBBEAN BLUE**  
#100151 \$19.25/YD



**CHARCOAL**  
#120429 \$19.25/YD

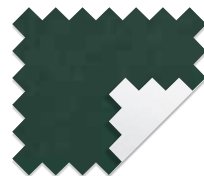

**FOREST GREEN**  
#120423 \$19.25/YD



**HARBOR BLUE**  
#120425 \$19.25/YD



**ROYAL BLUE**  
#120424 \$19.25/YD



**TAUPE 60"**  
#120428 \$19.25/YD



**WHITE 60"**  
#120432 \$19.25/YD

## SHELTER-RITE® BY SEAMAN CORPORATION

Tough as nails vinyl-coated polyester with matte finish. Completely waterproof and mildew resistant with excellent tear, puncture, and abrasion resistance. Stays flexible in extreme temperatures. Use HH-66 Vinyl Cement (p.163) to create seams without needing to sew. Use with the matte (dull) side facing out.

**\$17.95/YD**

### RECOMMENDED FOR:



Protecting and reinforcing worn or high-stress areas like dodger and bimini edges or around grommets and for truck and industrial tarps, tents, covers, heavy duty bags, and hurricane panels

**SEWING:** See Thread & Needle Recommendations p.245

**MATERIAL:** Vinyl-coated woven polyester

**WIDTH:** 61"

**WEIGHT:** 18 oz. per square yard

**SALE UNIT:** Sold per linear yard

► [Need a Sample?](#) (details p.11) | Find information on our helpful fabric resources on p.17

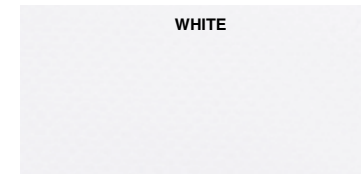

WHITE

#112011

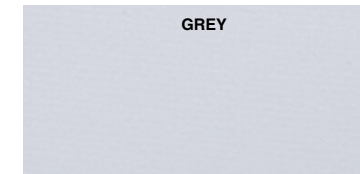

GREY

#112015

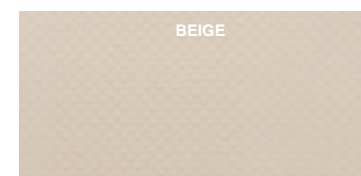

BEIGE

#112014

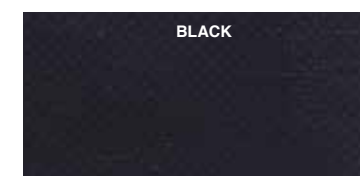

BLACK

#1120121

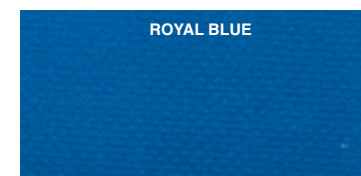

ROYAL BLUE

#112016

ALSO AVAILABLE AS 3" WIDE TAPE — PERFECT FOR EDGE REINFORCEMENT p.152



# FOAM BACKED HEADLINER

Perfect for renovating any boat interior! Made with Morbern's Seabrook Vinyl (p.36) and a high quality, flame-adhered 3/16" backing. Foam backed headliners hide imperfections better than vinyl alone. Install using 3M General Trim Adhesive (#73211 p.163). Max. continuous piece 15 yards.

**\$23.95/YD**

Sea White (off-white) #105466  
 White #105465  
 Lite Glacier #105467  
 Stinger Bisque #120332

Hide the staples in your headliner with matching Hidem Gimp on p.145

**RECOMMENDED FOR:**



Renovating any boat interior

**SEWING:** See Thread & Needle Recommendations p.245

**MATERIAL:** Vinyl

**WIDTH:** 54"

**THICKNESS:** 1/4" (with backing)

**SALE UNIT:** Sold per linear yard

► Need a Sample? (details p.11)

A HEADLINER ALTERNATIVE WITHOUT FOAM  
 Nauga Soft (p.39)

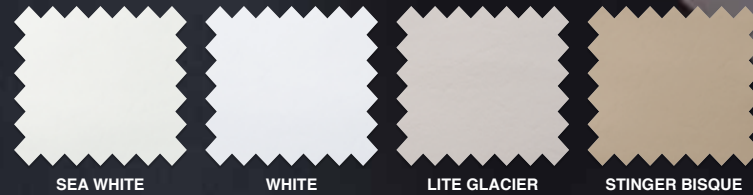

# MORBERN SEABROOK CHANNELING FABRIC

Pressed pleated marine vinyl designed specifically for boat seat cushions. Made from Seabrook Marine Vinyl (p.36), each tuck is filled with polyester fiberfill. Mildew resistant, flame retardant, durable and easy to clean. 3/4" thick. Pleated every 1-1/2".

**\$33.95/YD**

White #105993  
 Sea White (off-white) #105992  
 Lite Glacier #105994  
 Stinger Bisque #120331

**RECOMMENDED FOR:**



Seat backs and bottom

**WIDTH:** 54"

**WEIGHT:** 31 oz. per square yard

**SALE UNIT:** Sold per linear yard

► Need a Sample? (details p.11)

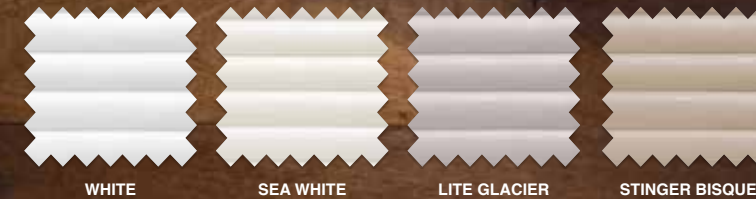

# HULL BLANKET HEADLINER/HULL LINER

Beautiful carpet-style headliner with great durability and stain, mold, and mildew resistance. The anti-static, colorfast, and moisture-proof qualities make this liner perfect for marine environments. Directional material (clear warp and fill orientation). Cuts easily with scissors without fraying. Install with 3M General Trim Adhesive (#73211, p.163).

**\$20.95/YD**

**RECOMMENDED FOR:**



Headliner or hull liner on uneven surfaces (can stretch or contract during installation)

**SEWING:** See Thread & Needle Recommendations p.245

**MATERIAL:** 100% polypropylene

**WIDTH:** 72"

**WEIGHT:** 14 oz. per square yard

**THICKNESS:** 3/16"

**FIRE RATING:** FMVSS 302

**SALE UNIT:** Sold per linear yard

► Need a Sample? (details p.11) | Find information on our helpful fabric resources on p.17



SILVER GREY #102637

SAND #102635

IVORY #103275



# Accent Your Seating with Channeling Fabric

See how we used Morbern Seabrook Channeling Fabric on our 2016 Project Powerboat at [Sailrite.com/How-to](http://Sailrite.com/How-to).

How To Make A Powerboat Lounge Cushion Video #X-HT-200704

How To Reupholster Back-To-Back Boat Lounge Seats Video #X-HT-300103

How To Make A Powerboat Aft Bench Cushion Video #X-HT-200706

# NAUGAHYDE® UNIVERSAL & ALL-AMERICAN

BY UNIROYAL



Popular fabric choice for modern, sporty, waterproof exterior cushions and boat seating. With an advanced BeautyGard protective finish, this expanded vinyl on jersey knit features great durability and tear strength, UV and weather resistance, and static dissipative slip finish. Stays soft under harsh conditions (-20° F cold crack rating) and meets small-scale flammability test requirements. Treated against bacterial and fungal micro-organisms. All-American is made with a higher gauge vinyl which makes it thicker, heavier, and tougher than Universal.

**SEWING:** See Thread & Needle Recommendations p.245 **MATERIAL:** Expanded vinyl on jersey knit **WIDTH:** 54" **SALE UNIT:** Sold per linear yard  
**RECOMMENDED FOR:** Outdoor cushions and seats on boats, auto interiors, cockpit cushions, and snowmobile seats

## UNIVERSAL 17.3 oz. per square yard 1-19 yards: \$15.95/YD | 20-39 yards \$14.51/YD | 40+ yards \$14.04/YD

 PURE WHITE #100615	 CREAM #100603	 DOE #100607	 JAVA #100610	 TAUPE #100620
 MEDIUM GRAY #100611	 PRAIRIE #100614	 NEUTRAL #100612	 DARK PEWTER #100606	 YELLOW #100622
 AMERICAN BEAUTY #100600	 DARK CHERRY #100605	 OXFORD WINE #100613	 STETSON #100619	 CORDOVAN #100602
 CINNABAR #100601	 SKY BLUE #100618	 REGIMENTAL BLUE #100617	 DEEP VIOLET #100623	 DARK NAVY #100604
 TEAL #100621	 FRENCH GREEN #100609	 FOREST #100608	 CYPRESS #100625	 GRAPHITE #100624
 RAVEN #100616	<p>Give your project a polished look with matching Naugahyde piping. p.147</p>			

► [Need a Sample?](#) (details p.11) | Find information on our helpful fabric resources on p.17



## ALL-AMERICAN 19.2 oz. per square yard 1-34 yards \$18.95/YD | 35+ yards \$16.11/YD

 BRIGHT WHITE #120016	 ADOBE WHITE #103521	 PARCHMENT #120017	 SAND #103522	 ALABASTER #102703
 DOVE #120015	 GUNMETAL #120014	 BRONZE #120019	 CINNABAR #120020	 PAPRIKA #120021
 CLARET #120022	 BURGUNDY #120023	 AMERICAN BEAUTY #120024	 TOMATO #120623	 DUSTY JADE #120025
 GROTTO #120026	 FOREST #120027	 YEW GREEN #120028	 ROYAL BLUE #102702	 REGIMENTAL BLUE #120029
 IMPERIAL BLUE #120030	 BLACK #107119			

► [Need a Sample?](#) (details p.11) | Find information on our helpful fabric resources on p.17

# SEABROOK VINYL BY MORBERN

Durable, multi-purpose vinyl with a faux leather look, perfect for marine, automotive and commercial upholstery. This vinyl is mildew resistant, flame resistant, durable, and easy to clean. 1,000 hours of weather resistance and a cold crack resistance up to -25° F. Some colors feature a dull matte finish (D) and others have a classic vinyl sheen.

1-19 yards: **\$13.95/YD**  
20-39 yards: **\$12.83/YD**  
40+ yards: **\$12.56/YD**

### RECOMMENDED FOR:



Marine exterior seating, cushions, furniture, spa covers, and automotive upholstery

**SEWING:** See Thread & Needle Recommendations p.245

**MATERIAL:** Vinyl

**WIDTH:** 54"

**WEIGHT:** 31 oz. per sq yard

**SALE UNIT:** Sold per linear yard

## Create a Cohesive Look All Around Your Boat with Other Seabrook Products

Get the perfect color and texture match by using our other Seabrook Vinyl products. The same fabric is available in:

- Foam backed headliner (p.32)
- Channeling fabric (p. 33)
- Piping (p.147)
- Hidem Gimp (p.145)



<b>GEL WHITE (D)</b> #105449	<b>SEA WHITE</b> #105969	<b>CHALK</b> #105970
<b>STINGER CREAM</b> #105971	<b>SEA SHELL (D)</b> #105972	<b>WHITE (D)</b> #105973
<b>ACTION YELLOW (D)</b> #105974	<b>LITE GLACIER</b> #105975	<b>MOONLITE</b> #105976
<b>MARIGOLD</b> #105977	<b>STINGER BISQUE</b> #105978	<b>MARBLE</b> #105979
<b>HOT ORANGE</b> #105980	<b>BLUE</b> #105981	<b>LIME</b> #105982
<b>AMERICAN BEAUTY</b> #105983	<b>PURPLE (D)</b> #105984	<b>DEEP SEA</b> #105985
<b>RUBY</b> #105986	<b>MIDNIGHT</b> #105987	<b>NU TEAL (D)</b> #105988
<b>PORCELAIN</b> #105989	<b>EBONY</b> #105990	<b>FOREST</b> #105991



Morbern Hexx gives a cool, modern edge to motorcycle, scooter or other vehicle seats!  
Photo and upholstery by customer Katherine F.

## MORBERN HEXX & SHOCK



Textured vinyl with industrial design. Mobern's Hexx and Shock are bringing a little more style to vinyl. Hexx features a high-luster finish with a micro-hexagon design, while Shock has a metallic finish with an embossed twill design. Mildew resistant, flame retardant, durable and easy to clean, Hexx and Shock are durable, versatile vinyls for a variety of applications.

**SEWING:** See Thread & Needle Recommendations p.245 **MATERIAL:** Mellohide vinyl **WIDTH:** 54" **WEIGHT:** 20.5 oz. per sq yard

**SALE UNIT:** Sold per linear yard **RECOMMENDED FOR:** Marine exterior and interior seating, automotive and hospitality upholstery and PWC and motorcycle seats

**HEXX:** 1-19 yards **\$17.95/YD** | 20-39 yards **\$16.51/YD** | 40+ yards **\$16.16/YD** **SHOCK:** 1-19 yards **\$16.95/YD** | 20-39 yards **\$15.59/YD** | 40+ yards **\$15.26/YD**

<b>PEARL WHITE</b> #120362	<b>SAND</b> #120352	<b>BUTTER</b> #120355	<b>LATTE</b> #120351	<b>ESPRESSO</b> #120349
<b>SILVER</b> #120347	<b>CHARCOAL</b> #120358	<b>GRAPHITE BLUE</b> #120357	<b>EGGPLANT</b> #120354	<b>DARK BLUE</b> #120353
<b>COBALT BLUE</b> #120356	<b>BORDEAUX</b> #120359	<b>PUMPKIN</b> #120350	<b>COPPER</b> #120348	<b>MOSS</b> #120361
<b>PALM</b> #120360	<b>SUPERSONIC</b> #120370	<b>THUNDER</b> #120364	<b>STORM</b> #120365	<b>CARBON</b> #120366
<b>JET</b> #120367	<b>HORSEPOWER</b> #120363	<b>HOT ROD</b> #120369	<b>LIGHTNING</b> #120368	



**FREE VIDEO:** "How to Recover a Personal Watercraft Seat"  
Watch at [Sailrite.com](https://www.sailrite.com) (#X-HT-200636)

## ALLSPORT 4-WAY STRETCH VINYL

Durable, multi-purpose vinyl designed with a special 360° 4-way stretch. This highly abrasion resistant vinyl (30,000 double rubs) will stretch to contour around any frame allowing for a tight fit and easy tailoring. 1,000 hours of weather resistance with a cold resistance past -60° F. Stain resistant and easy to clean (mild soap and water).

1-19 yards \$27.95/YD

20-39 yards \$25.71/YD

40+ yards \$25.16/YD

### RECOMMENDED FOR:



Seating and interiors for vehicles, ATVs, golf carts, motorcycles, ski lifts, snowmobiles, tractors, personal watercrafts, boats, office chairs, and restaurants

**SEWING:** See Thread & Needle Recommendations p.245

**MATERIAL:** 4-way stretch vinyl

**WIDTH:** 54"

**WEIGHT:** 24 oz. per square yard

**FIRE RATING:** FMVSS-302

**SALE UNIT:** Sold per linear yard

► [Need a Sample?](#) (details p.11) | Find information on our helpful fabric resources on p.17



CHALK

#104180



SILVER MET

#104181

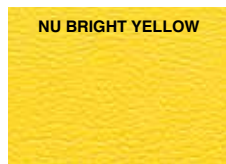

NU BRIGHT YELLOW

#104179

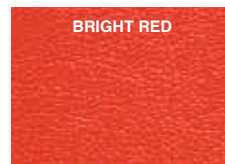

BRIGHT RED

#104176



AZTEC RED

#104177

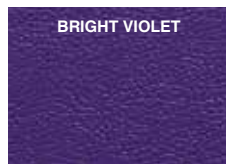

BRIGHT VIOLET

#104178



MARINE GREEN

#104173



ROYAL BLUE

#104174



ELECTRIC BLUE

#104175

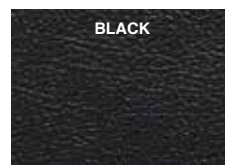

BLACK

#104182

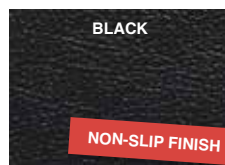

BLACK

#104183

## NAUGAHYDE® NAUGA SOFT BY UNIROYAL

This soft vinyl upholstery fabric on a napped jersey knit makes a great choice for any home or boat owner. Rated at one-million double rubs, Nauga Soft boasts excellent tear strength, scuff and scrape resistance, and a static dissipative slip finish. The Advanced BeautyGard Protective finish treats against bacterial and fungal micro-organisms and keeps the fabric feeling soft and supple (-20°F cold crack). Easy to clean. Meets small-scale flammability test requirements. 1-34 yards \$22.95/YD | 35+ yards \$19.51/YD

**SEWING:** See Thread & Needle Recommendations p.245 **MATERIAL:** Soft vinyl **WIDTH:** 54" **WEIGHT:** 18.8 oz. per sq yard **SALE UNIT:** Sold per linear yard

**RECOMMENDED FOR:** Indoor upholstery projects and marine headliner



SOFT WHITE

#100668

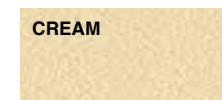

CREAM

#100653



DOESKIN

#100655

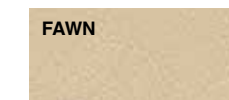

FAWN

#100656

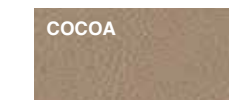

COCOA

#100652



VELVET BROWN

#100670

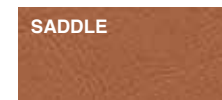

SADDLE

#100666



HARNESS

#100658



CABERNET

#100651

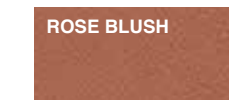

ROSE BLUSH

#100665



TAPESTRY RED

#100669

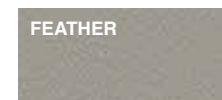

FEATHER

#100657



BLUE FOG

#100650



LAKE LOUISE

#100660



DEEP SAPPHIRE

#100667



MINT LEAF

#100663



DEEP SEA

#100654



LAUREL

#100661



IVY

#100659

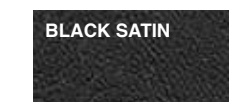

BLACK SATIN

#100671

► [Need a Sample?](#) (details p.11) | Find information on our helpful fabric resources on p.17



Sailrite.com



A #145256-0001 B #16001-0001 C #56102-0000 D #69010-0004 E #56105-0000

# SUNBRELLA® UPHOLSTERY BY GLEN RAVEN

As the preferred indoor/outdoor fabric, Sunbrella Upholstery Fabric boasts the same great solution-dyed fade, water, and mildew resistant fibers as the Marine Grade line, but features a luxurious, soft hand for the comforts and care of home. This beautiful furniture fabric makes any marine upholstery application worry-free for families and pets. It's amazingly easy to maintain and most spills can be cleaned with mild soap and water.

**SEWING:** See Thread & Needle Recommendations p.245 **MATERIAL:** 100% solution-dyed acrylic (Except where noted. See key below)

**WIDTH:** 54" **WEIGHT:** Varies by collection **WARRANTY:** 5 year limited **SALE UNIT:** Sold per linear yard

### RECOMMENDED FOR:



Cushions, pillows, upholstery projects, curtains and drapery, boat interiors and patio umbrellas

### FABRIC CONTENT:

◆ Acrylic, PVC, Polyester   ◆ Acrylic, other   ◆ Acrylic, Polyester

► [Need a Sample?](#) (details p.11) | Find information on our helpful fabric resources on p.17

### UPHOLSTERY FABRIC

## CANVAS COLLECTION

Weight:  
8.22 oz. per square yard

Details p.40

<b>TEAL</b> #5456-0000 \$22.95/YD	<b>ARUBA</b> #5416-0000 \$22.95/YD	<b>GLACIER</b> #5428-0000 \$22.95/YD	<b>SPA</b> #5413-0000 \$22.95/YD
<b>MINERAL BLUE</b> #5420-0000 \$22.95/YD	<b>AIR BLUE</b> #5410-0000 \$22.95/YD	<b>SKY BLUE</b> #5424-0000 \$22.95/YD	<b>CAPRI</b> #5426-0000 \$22.95/YD
<b>SAPPHIRE BLUE</b> #5452-0000 \$22.95/YD	<b>PACIFIC BLUE</b> #5401-0000 \$22.95/YD	<b>REGATTA</b> #5493-0000 \$22.95/YD	<b>TRUE BLUE</b> #5499-0000 \$22.95/YD
<b>NAVY</b> #5439-0000 \$22.95/YD	<b>RAVEN BLACK</b> #5471-0000 \$22.95/YD	<b>BLACK</b> #5408-0000 \$22.95/YD	<b>COAL</b> #5489-0000 \$22.95/YD
<b>CHARCOAL</b> #54048-0000 \$22.95/YD	<b>GRANITE</b> #5402-0000 \$22.95/YD	<b>FLAX</b> #5492-0000 \$22.95/YD	<b>CANVAS</b> #5453-0000 \$22.95/YD
<b>BIRD'S EYE</b> #5472-0000 \$22.95/YD	<b>VELLUM</b> #5498-0000 \$22.95/YD	<b>ANTIQUE BEIGE</b> #5422-0000 \$22.95/YD	<b>HEATHER BEIGE</b> #5476-0000 \$22.95/YD

► [Need a Sample?](#) (details p.11) | Find information on our helpful fabric resources on p.17



UPHOLSTERY FABRIC

# CANVAS COLLECTION

Weight:  
8.22 oz. per square yard

Details p.40

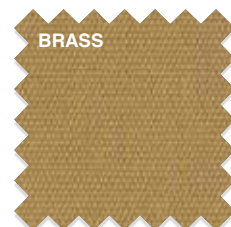

BRASS #5484-0000 \$22.95/YD



WHEAT #5414-0000 \$22.95/YD



MAIZE #5412-0000 \$22.95/YD

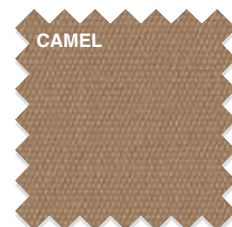

CAMEL #5468-0000 \$22.95/YD

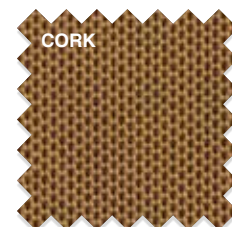

CORK #5448-0000 \$22.95/YD



COCOA #5425-0000 \$22.95/YD



TEAK #5488-0000 \$22.95/YD



CHESTNUT #57001-0000 \$22.95/YD

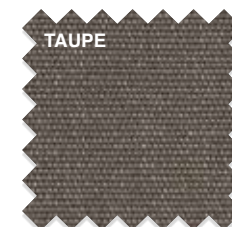

TAUPE #5461-0000 \$22.95/YD



BAY BROWN #5432-0000 \$24.95/YD



WALNUT #5470-0000 \$22.95/YD



FOREST GREEN #5446-0000 \$22.95/YD



FERN #5487-0000 \$22.95/YD



PALM #5421-0000 \$24.95/YD



MACAW #5429-0000 \$24.95/YD



GINKGO #54011-0000 \$24.95/YD



PARROT #5405-0000 \$24.95/YD



BUTTERCUP #5438-0000 \$22.95/YD



SUNFLOWER YELLOW #5457-0000 \$22.95/YD



TANGERINE #5406-0000 \$24.95/YD



TUSCAN #5417-0000 \$24.95/YD



MELON #5415-0000 \$22.95/YD

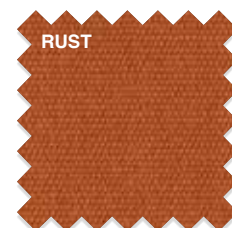

RUST #54010-0000 \$24.95/YD



TERRACOTTA #5440-0000 \$24.95/YD



HENNA #5407-0000 \$24.95/YD

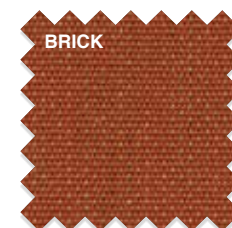

BRICK #5409-0000 \$24.95/YD



JOCKEY RED #5403-0000 \$24.95/YD



LOGO RED #5477-0000 \$24.95/YD



BLUSH #57000-0000 \$24.95/YD



HOT PINK #5462-0000 \$24.95/YD



BURGUNDY #5436-0000 \$24.95/YD



IRIS #57002-0000 \$24.95/YD



NATURAL #5404-0000 \$22.95/YD



WHITE #57003-0000 \$22.95/YD

## Choose Just the Right Fabric For Every Area on Your Boat

The fabric you use for cushions in your cockpit has different needs than the fabrics you choose for your cabin down below. In our "Cockpit vs. Cabin Cushion Fabrics" guide we break down the differences between the two areas so you can get the best in comfort and performance.

Find this guide at [Sailrite.com](http://Sailrite.com). Just search #X-HT-300006.

► Need a Sample? (details p.11) | Find information on our helpful fabric resources on p.17

## Do-It-Yourself Books & DVDs

### RE-UPHOLSTER YOUR OWN CHAIR DVD 161 MIN.

Learn to re-upholster just about any style of chair with this comprehensive instructional DVD. Includes how to remove old fabric and tack strips, pattern new fabric, install piping, sew, and fasten new coverings.

#103174 \$19.95-~~EA~~ \$9.95 EA

### MAKE YOUR OWN PILLOWS, SHAMS & BED SKIRT DVD 127 MIN.

Step-by-step instructions for a standard throw pillow, round pillow, and pillows with a zippered opening, boxed corners, piping, or button forms, as well as zippered or envelope style pillow shams and a bed skirt.

#103514 \$19.95-~~EA~~ \$5.00 EA

### MAKE YOUR OWN CUSHIONS DVD V.II 240 MIN.

A compilation of our best cushion videos. Includes instructions for 8 cushion projects for your boat's v-berth, salon & cockpit. Great for both beginner and experienced sewers.

#105424 \$15.95 EA

### SEW WHAT! BAGS

by Lexie Barnes, 152 pp. Hard cover.

Simple, pattern-free sewing for the eco-conscious crafter. Requires only an inventive spirit, fun fabric, and a basic sewing machine. Illustrated step-by-step instructions for 17 core projects including totes, drawstring sacks, messenger bags, organizers, satchels, purses and more.

#102747 \$16.95 EA





UPHOLSTERY FABRIC

**SPECTRUM COLLECTION** 6.87 oz. per square yard | Details p.40

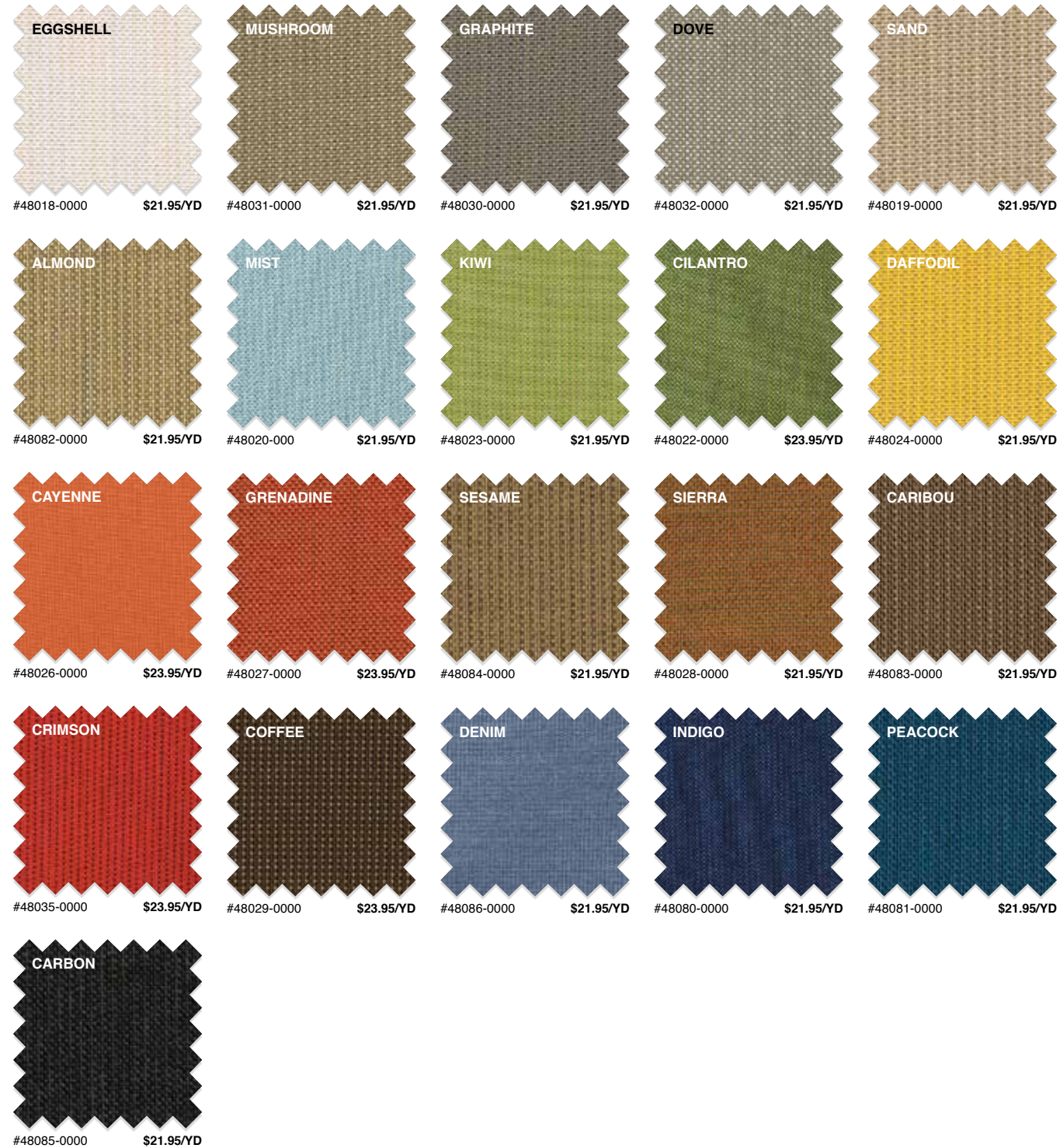

► [Need a Sample?](#) (details p.11) | Find information on our helpful fabric resources on p.17

UPHOLSTERY FABRIC

**DUPIONE COLLECTION\*** 10.1 oz. per square yard | Details p.40



\*Dupione Collection fabrics are railroaded: Ribs run the width of the fabric.

► [Need a Sample?](#) (details p.11) | Find information on our helpful fabric resources on p.17

UPHOLSTERY FABRIC

**SAILCLOTH COLLECTION** 13.36 oz. per square yard | Details p.40

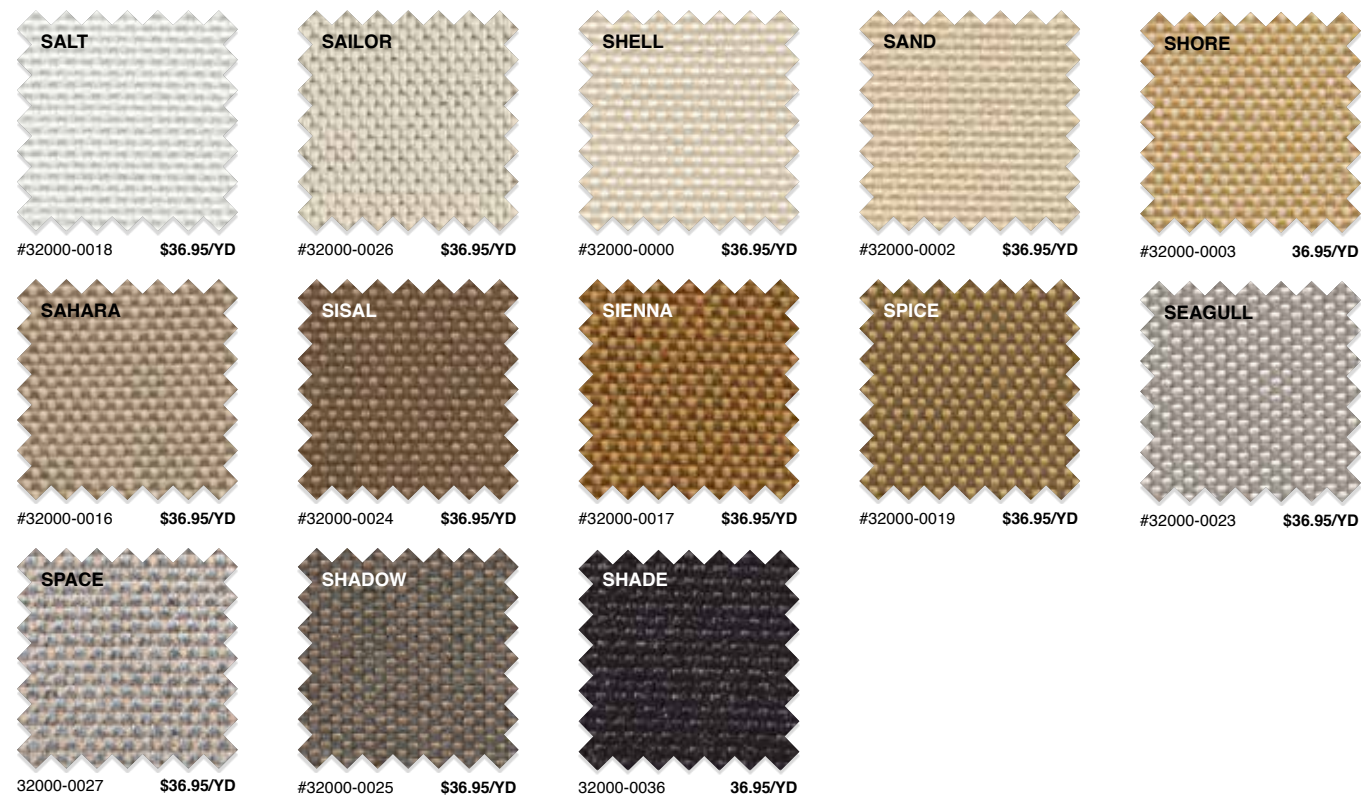

**RIB COLLECTION** 12.85 oz. per square yard | Details p.40

Designed for sling applications and strong enough to support the weight of occupants. (Comfort Sling)

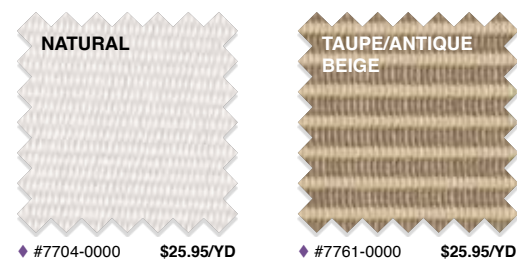

► **Need a Sample?** (details p.11) | Find information on our helpful fabric resources on p.17

UPHOLSTERY FABRIC

**HERITAGE COLLECTION** 10.43 oz. per square yard | Details p.40



**RENAISSANCE FABRICS**

Sunbrella Renaissance fabrics combine post-industrial recycled Sunbrella fiber with virgin Sunbrella fiber for vintage charm, rich coloration, and a soft feel.



**RECYCLE MY SUNBRELLA**

The Recycle My Sunbrella program reclaims pre- and post-consumer Sunbrella waste and re-purposes it for incorporation into a variety of recycled products. See [recyclemysunbrella.com](http://recyclemysunbrella.com) for details.

**LINEN COLLECTION** 8.9 oz. per square yard | Details p.40



► **Need a Sample?** (details p.11) | Find information on our helpful fabric resources on p.17

*New!*

UPHOLSTERY FABRIC

## MAKERS COLLECTION

The latest collection from Sunbrella brings together the look and spirit of traditional hand woven fabrics with modern manufacturing. The colors, weaves and styles of the Makers Collection pay tribute to artisans and time-honored crafts, to bring an accessible, modern twist on tradition.

Details p.40



**NEW GATEWAY INDIGO #56102-0000** \$22.95/YD  
8.22 oz/sq.yd (repeat H: 8.87")



**NEW ADAPTATION INDIGO #69010-0004** \$38.95/YD  
◆ 16.86 oz/sq.yd (repeat H: 3.5" x V: 2.62")



**NEW CANVAS CYAN #56105-0000** \$26.95/YD  
8.22 oz/sq.yd

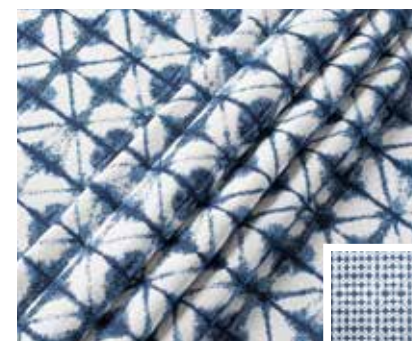

**NEW MIDORI INDIGO #145256-0001** \$48.95/YD  
14.06 oz/sq.yd (repeat H: 18.8" x V: 28")



**NEW CAST BREEZE #48094-0000** \$21.95/YD  
6.81 oz/sq.yd

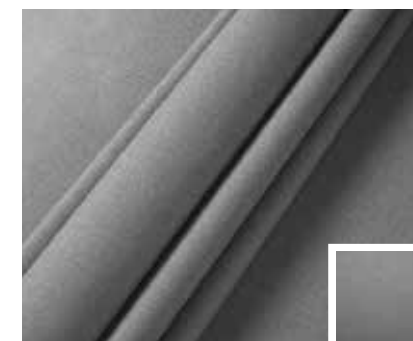

**NEW BLEND MIST #16001-0009** \$39.95/YD  
◆ 12.08 oz/sq.yd



**NEW BLEND CLAY #16001-0006** \$39.95/YD  
◆ 12.08 oz/sq.yd

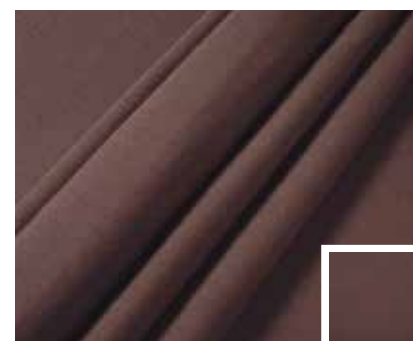

**NEW CAST SABLE #48097-0000** \$21.95/YD  
6.81 oz/sq.yd

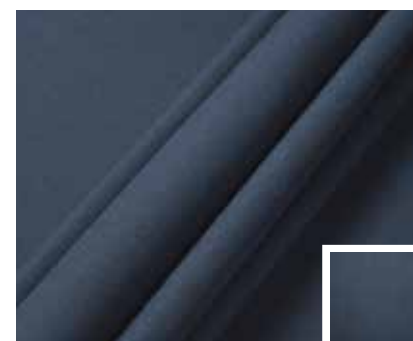

**NEW BLEND INDIGO #16001-0001** \$39.95/YD  
◆ 12.08 oz/sq.yd

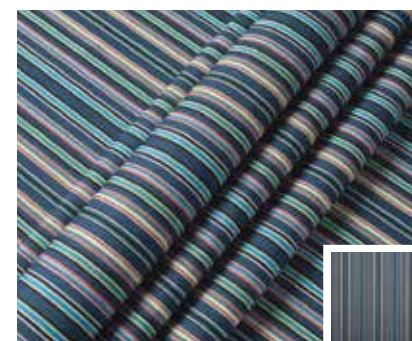

**NEW CULTIVATE BREEZE #56100-0000** \$29.95/YD  
8.89 oz/sq.yd (repeat H: 8.87")

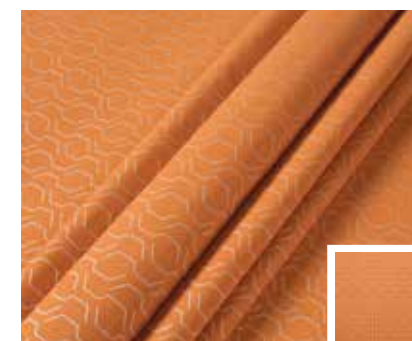

**NEW ADAPTATION APRICOT #69010-0003** \$38.95/YD  
◆ 16.86 oz/sq.yd (repeat H: 3.5" x V: 2.62")



**NEW GATEWAY ASPEN #56104-0000** \$22.95/YD  
8.22 oz/sq.yd (repeat H: 8.87")

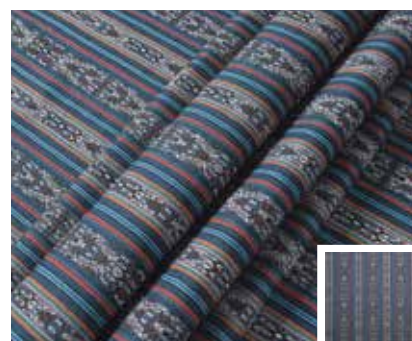

**NEW ARTISTRY INDIGO #145340-0001** \$45.95/YD  
12.23 oz/sq.yd (repeat H: 7" x V: 9.83")



**NEW GATEWAY FUSE #56103-0000** \$22.95/YD  
8.22 oz/sq.yd (repeat H: 8.87")



**NEW CAST HORIZON #48091-0000** \$21.95/YD  
6.81 oz/sq.yd



**NEW BLEND HONEY #16001-0013** \$39.95/YD  
◆ 12.08 oz/sq.yd

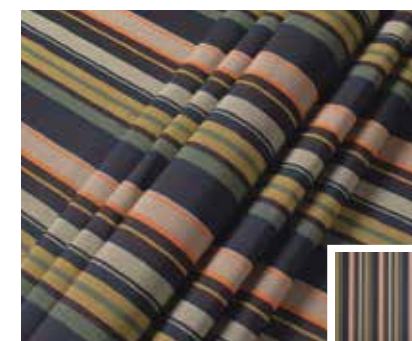

**NEW TRADITION ASPEN #5653-0000** \$27.95/YD  
8.22 oz/sq.yd (repeat H: 8.9")

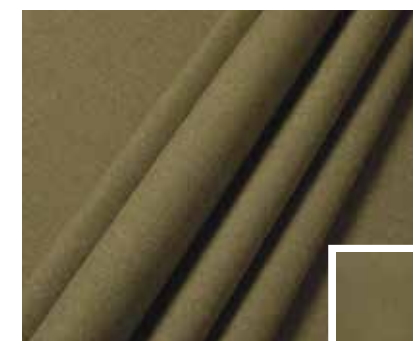

**NEW BLEND CACTUS #16001-0005** \$39.95/YD  
◆ 12.08 oz/sq.yd

► [Need a Sample?](#) (details p.11) | Find information on our helpful fabric resources on p.17

◆ Acrylic, PVC, Polyester   ◆ Acrylic, Other   ◆ Acrylic, Polyester

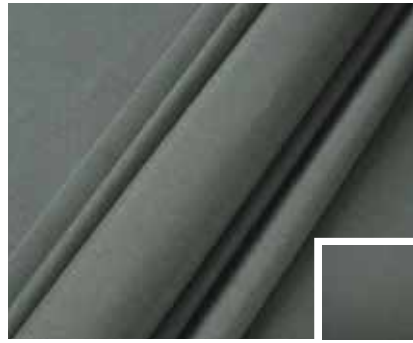

**NEW CAST SAGE #48092-0000** \$21.95/YD  
6.81 oz/sq.yd

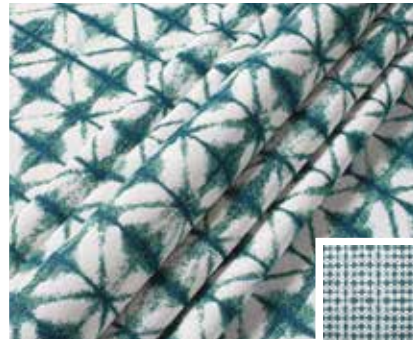

**NEW MIDORI BERMUDA #145256-0002** \$48.95/YD  
14.06 oz/sq.yd (repeat H: 18.8" x V: 28")



**NEW GATEWAY TROPIC #56101-0000** \$22.95/YD  
8.22 oz/sq.yd (repeat H: 8.87")



**NEW PARADIGM STONE #40484-0001** \$27.95/YD  
6.81 oz/sq.yd (repeat H: 14.3" x V: 14.4")

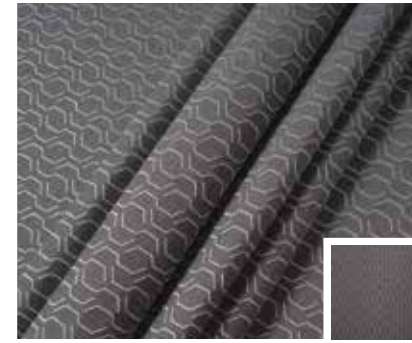

**NEW ADAPTATION STONE #69010-0002** \$38.95/YD  
◆ 16.86 oz/sq.yd (repeat H: 3.5" x V: 2.62")



**NEW ARTISTRY ASH #145340-0002** \$45.95/YD  
12.23 oz/sq.yd (repeat H: 7" x V: 9.83")



**NEW SPECTRUM AZTEC #48090-0000** \$21.95/YD  
6.87 oz/sq.yd



**NEW BLEND LAGOON #16001-0002** \$39.95/YD  
◆ 12.08 oz/sq.yd

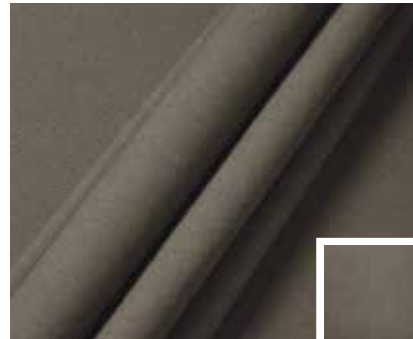

**NEW BLEND SAGE #16001-0004** \$39.95/YD  
◆ 12.08 oz/sq.yd



**NEW BLEND COAL #16001-0008** \$39.95/YD  
◆ 12.08 oz/sq.yd

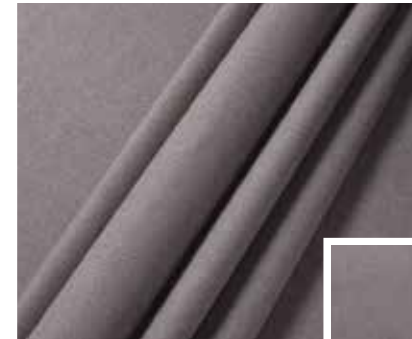

**NEW BLEND FOG #16001-0010** \$39.95/YD  
◆ 12.08 oz/sq.yd



**NEW SHORE LINEN #56054-0000** \$24.95/YD  
8.22 oz/sq.yd (repeat H: 1.5")

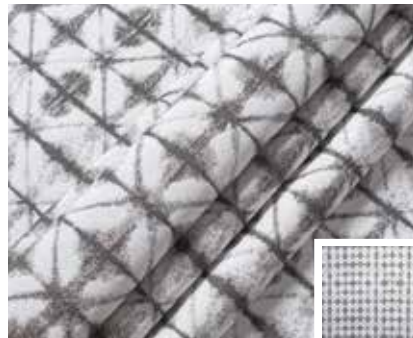

**NEW MIDORI STONE #145256-0005** \$48.95/YD  
14.06 oz/sq.yd (repeat H: 18.8" x V: 28")



**NEW BLEND LINEN #16001-0014** \$39.95/YD  
◆ 12.08 oz/sq.yd

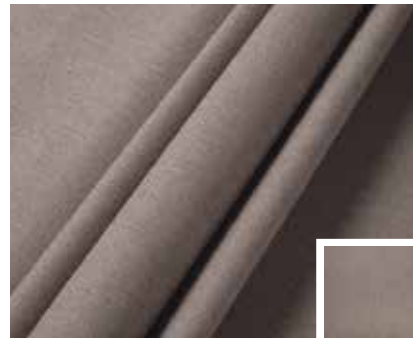

**NEW BLEND NOMAD #16001-0011** \$39.95/YD  
◆ 12.08 oz/sq.yd



**NEW ADAPTATION LINEN #69010-0001** \$38.95/YD  
◆ 16.86 oz/sq.yd (repeat H: 3.5" x V: 2.62")



**NEW BLEND SABLE #16001-0003** \$39.95/YD  
◆ 12.08 oz/sq.yd



**NEW CULTIVATE TANDOORI #56106-0000** \$29.95/YD  
8.89 oz/sq.yd (repeat H: 8.87")

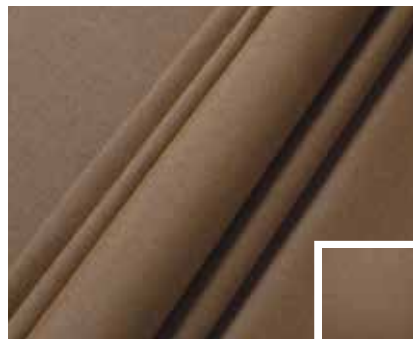

**NEW CAST TEAK #48093-0000** \$21.95/YD  
6.81 oz/sq.yd



**NEW CULTIVATE STONE #56107-0000** \$29.95/YD  
8.89 oz/sq.yd (repeat H: 8.87")



**NEW BLEND SAND #16001-0012** \$39.95/YD  
◆ 12.08 oz/sq.yd



**NEW BLEND CHERRY #16001-0007** \$39.95/YD  
◆ 12.08 oz/sq.yd



**NEW SPECTRUM RUBY #48095-0000** \$23.95/YD  
6.87 oz/sq.yd



**NEW SPECTRUM CHERRY #48096-0000** \$23.95/YD  
6.87 oz/sq.yd

► [Need a Sample?](#) (details p.11) | Find information on our helpful fabric resources on p.17

◆ Acrylic, PVC, Polyester ◆ Acrylic, Other ◆ Acrylic, Polyester

UPHOLSTERY FABRIC

# SHIFT COLLECTION

Shift your thinking about performance fabrics! Sunbrella designers are taking their fabrics to the next level by playing with pattern, texture and fibers in this new collection. All fabrics can be mixed and matched for a cohesive, layered look.

Details p.40



**LOFT GRAPE #46058-0010** \$40.95/YD  
10.31 oz/sq.yd



**INTEGRATED STEEL #69006-0008** \$38.95/YD  
17.16 oz/sq.yd (repeat H: 7" x V: 8.55")



**LOFT WISTERIA #46058-0008** \$40.95/YD  
10.31 oz/sq.yd

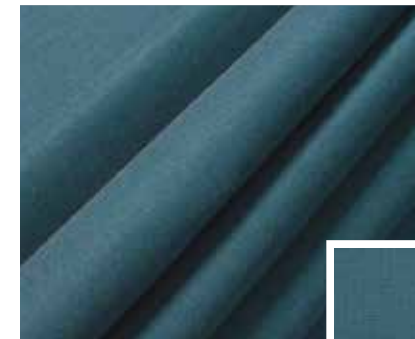

**SPOTLIGHT LAGOON #15000-0005** \$25.95/YD  
11.07 oz/sq.yd



**LOFT INDIGO #46058-0012** \$40.95/YD  
10.31 oz/sq.yd



**CONNECT COSMIC #58043-0000** \$25.95/YD  
8.72 oz/sq.yd (repeat H: 8.85" x V: 7.54")



**ESCAPADE ELECTRO #57010-0000** \$25.95/YD  
12.37 oz/sq.yd (repeat H: 6.81")



**SPOTLIGHT ROSE #15000-0011** \$27.95/YD  
11.07 oz/sq.yd



**CONNECT TWILIGHT #58044-0000** \$25.95/YD  
8.72 oz/sq.yd (repeat H: 8.85" x V: 7.54")



**SPOTLIGHT GALAXY #15000-0006** \$25.95/YD  
11.07 oz/sq.yd



**RADIANT LAGOON #69008-0003** \$38.95/YD  
15.38 oz/sq.yd (repeat H: 14" x V: 27.06")

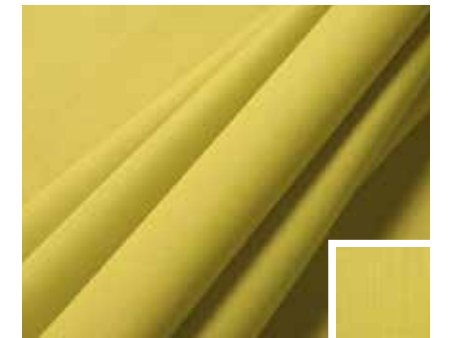

**SPOTLIGHT CITRON #15000-0008** \$25.95/YD  
11.07 oz/sq.yd



**SPOTLIGHT WISTERIA #15000-0012** \$25.95/YD  
11.07 oz/sq.yd



**INTEGRATED INDIGO #69006-0009** \$38.95/YD  
17.16 oz/sq.yd (repeat H: 7" x V: 8.55")



**SPOTLIGHT PEBBLE #15000-0002** \$25.95/YD  
11.07 oz/sq.yd



**SPOTLIGHT INDIGO #15000-0007** \$25.95/YD  
11.07 oz/sq.yd



**ESCAPADE TWILIGHT #57008-0000** \$25.95/YD  
12.37 oz/sq.yd (repeat H: 6.81")



**LOFT CRIMSON #46058-0009** \$40.95/YD  
10.31 oz/sq.yd

► [Need a Sample?](#) (details p.11) | Find information on our helpful fabric resources on p.17

◆ Acrylic, PVC, Polyester   ◆ Acrylic, Other   ◆ Acrylic, Polyester



**LOFT TURQUOISE #46058-0011** \$40.95/YD  
10.31 oz/sq.yd



**CONNECT FUSION #58041-0000** \$25.95/YD  
8.72 oz/sq.yd (repeat H: 8.85" x V: 7.54")

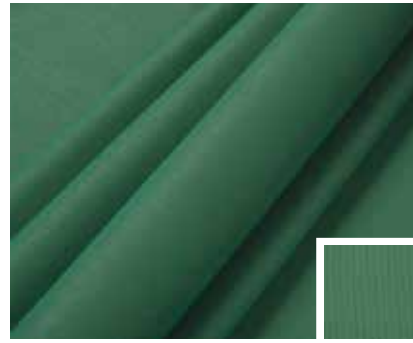

**SPOTLIGHT EMERALD #15000-0004** \$25.95/YD  
11.07 oz/sq.yd



**LOFT FLAX #46058-0004** \$40.95/YD  
10.31 oz/sq.yd



**INTEGRATED DUNE #69006-0007** \$38.95/YD  
17.16 oz/sq.yd (repeat H: 7" x V: 8.55")



**LOFT DUNE #46058-0007** \$40.95/YD  
10.31 oz/sq.yd



**ESCAPADE FUSION #57009-0000** \$25.95/YD  
12.37 oz/sq.yd (repeat H: 6.81")



**SPOTLIGHT FLAME #15000-0010** \$27.95/YD  
11.07 oz/sq.yd



**RADIANT SANGRIA #69008-0004** \$40.95/YD  
15.38 oz/sq.yd (repeat H: 14" x V: 27.06")



**RADIANT SLATE #69008-0002** \$38.95/YD  
15.38 oz/sq.yd (repeat H: 14" x V: 27.06")



**LOFT PEBBLE #46058-0005** \$40.95/YD  
10.31 oz/sq.yd



**RADIANT DUNE #69008-0001** \$38.95/YD  
15.38 oz/sq.yd (repeat H: 14" x V: 27.06")



**RADIANT KIWI #69008-0005** \$38.95/YD  
15.38 oz/sq.yd (repeat H: 14" x V: 27.06")



**SPOTLIGHT AZURE #15000-0009** \$25.95/YD  
11.07 oz/sq.yd



**INTEGRATED PEWTER #69006-0006** \$38.95/YD  
17.16 oz/sq.yd (repeat H: 7" x V: 8.55")

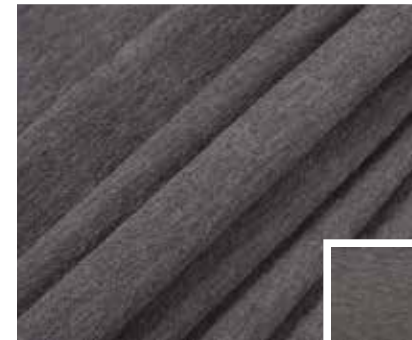

**LOFT GREY #46058-0006** \$40.95/YD  
10.31 oz/sq.yd



**ESCAPADE VIVID #57011-0000** \$25.95/YD  
12.37 oz/sq.yd (repeat H: 6.81")

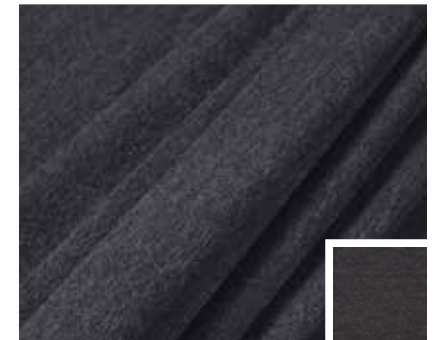

**LOFT CHAR #46058-0013** \$40.95/YD  
10.31 oz/sq.yd



**CONNECT DUNE #58042-0000** \$25.95/YD  
8.72 oz/sq.yd (repeat H: 8.85" x V: 7.54")



**SPOTLIGHT DUNE #15000-0001** \$25.95/YD  
11.07 oz/sq.yd

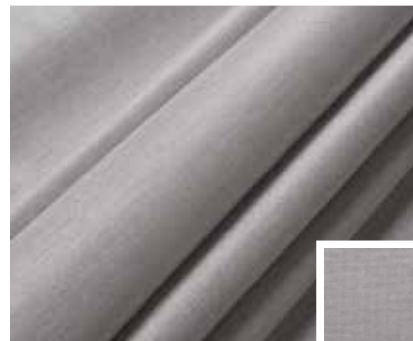

**SPOTLIGHT ASH #15000-0003** \$25.95/YD  
11.07 oz/sq.yd



**RADIANT SILVER #69008-0000** \$38.95/YD  
15.3 oz/sq.yd (repeat H: 14" x V: 27.06")



**LOFT WHITE #46058-0003** \$40.95/YD  
10.31 oz/sq.yd

► [Need a Sample?](#) (details p.11) | Find information on our helpful fabric resources on p.17

◆ Acrylic, PVC, Polyester   ◆ Acrylic, Other   ◆ Acrylic, Polyester



UPHOLSTERY FABRIC

# PATTERNS

Details p.40



**BLOX SLATE #45542-0000**  
11.65 oz/sq.yd (repeat H: 9.33" x V: 8.8")

\$39.95/YD



**MILANO DAWN #56087-0000**  
8.3 oz/sq.yd (repeat H: 11.02")

\$22.95/YD



**MAXIM HEATHER BEIGE #5674-0000**  
8.22 oz/sq.yd (repeat H: 4.18")

\$22.95/YD



**FRETWORK PEWTER #45991-0002**  
12.51 oz/sq.yd (repeat H: 7" x V: 14.74")

\$39.95/YD



**DECADE SAND #58025-0000**  
8 oz/sq.yd (repeat H: 6.72")

\$22.95/YD



**VOLT SAND #58018-0000**  
9 oz/sq.yd

\$24.95/YD



**FOSTER METALLIC #56051-0000**  
8.22 oz/sq.yd (repeat H: 6.75")

\$22.95/YD\*



**MAINSTREET WREN #42048-0005**  
◆ 11.67 oz/sq.yd (repeat H: 0.25" x V: 0.33")

\$39.95/YD



**NEO SILK #45718-0000**  
13 oz/sq.yd (repeat H: 3.43" x V: 3.5")

\$40.95/YD



**MAINSTREET LATTE #42048-0009**  
◆ 11.67 oz/sq.yd (repeat V: 0.33" x H: 0.25")

\$39.95/YD



**EMPIRE DOVE #45837-0002**  
14.25 oz/sq.yd (repeat H: 14" x V: 8.87")

\$39.95/YD



**FREQUENCY SAND #56094-0000**  
8.22 oz/sq.yd

\$22.95/YD

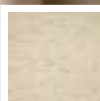

**FRETWORK FLAX #45991-0001**  
12.51 oz/sq.yd (repeat H: 7" x V: 14.74")

\$39.95/YD

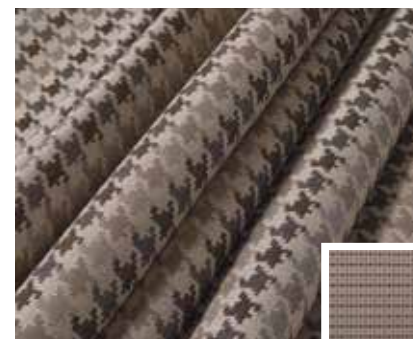

**BINGHAM GRAPHITE #45789-0000**  
13.3 oz/sq.yd (repeat H: 4.285" x V: 2")

\$40.95/YD



**CAST ASH #40428-0000**  
6.81 oz/sq.yd

\$21.95/YD



**ACTION LINEN #44285-0000**  
9.92 oz/sq.yd

\$35.95/YD



**REGENCY SAND #5695-0000**  
8.59 oz/sq.yd (repeat H: 9")

\$22.95/YD



**BESSEMER #7253-0000**  
9.73 oz/sq.yd (repeat H: 13.12" x V: 13.5")

\$29.95/YD



**ECHO TEAK #8077-0000**  
10.1 oz/sq.yd

\$26.95/YD



**ACTION TAUPE #44285-0003**  
9.92 oz/sq.yd

\$35.95/YD



**CAST SHALE #40432-0000**  
6.81 oz/sq.yd

\$21.95/YD



► [Need a Sample?](#) (details p.11) | Find information on our helpful fabric resources on p.17

◆ Acrylic, PVC, Polyester    ◆ Acrylic, Other    ◆ Acrylic, Polyester



UPHOLSTERY FABRIC

# PATTERNS

Details p.40



**ACCORD II CRIMSON #45936-0000**  
12.4 oz/sq.yd (repeat H: 3.5" x V: 3.43")

\$39.95/YD



**DORSETT CHERRY #56059-0000**  
8.22 oz/sq.yd (repeat H: 3.4")

\$24.95/YD



**ELEGANCE MARBLE #45746-0001**  
13.61 oz/sq.yd (repeat H: 14" x V: 13.48")

\$39.95/YD



**FRETWORK CAMEO #45991-0003**  
12.51 oz/sq.yd (repeat H: 7" x V: 14.74")

\$39.95/YD



**CAST PETAL #40431-0000**  
6.81 oz/sq.yd

\$21.95/YD



**DIMONE SEQUOIA #8031-0000**  
10.1 oz/sq.yd (repeat H: 5.5")

\$27.95/YD



**DOLCE MANGO #56000-0000**  
8.22 oz/sq.yd (repeat H: 8.9")

\$22.95/YD



**CABANA FLAME #58028-0000**  
8.3 oz/sq.yd (repeat H: 6.81")

\$24.95/YD



**SHORE FLAME #58031-0000**  
8.3 oz/sq.yd (repeat H: 1.53")

\$24.95/YD



**ASTORIA SUNSET #56095-0000**  
8.22 oz/sq.yd (repeat H: 8.87")

\$24.95/YD



**HARWOOD CRIMSON #5603-0000**  
8.59 oz/sq.yd (repeat H: 1.36")

\$24.95/YD



**DAVIDSON REDWOOD #5606-0000**  
8.59 oz/sq.yd (repeat H: 4.5")

\$22.95/YD



**CAROUSEL CONFETTI #7774-0000**  
◆ 12.85 oz/sq.yd (repeat H: 8.8")

\$26.95/YD



**MODE SEASIDE #58005-0000**  
9 oz/sq.yd (repeat H: 7.77")

\$24.95/YD



**BRANNON REDWOOD #5612-0000**  
8.22 oz/sq.yd (repeat H: 8.87")

\$22.95/YD



**FISCHER SUNSET #45885-0001**  
14.5 oz/sq.yd (repeat H: 14" x V: 18")

\$48.95/YD



**GATEWAY BLUSH #58038-0000**  
8.22 oz/sq.yd (repeat H: 8.87")

\$22.95/YD



**BRAVADA SALSA #5601-0000**  
8.22 oz/sq.yd (repeat H: 6.81")

\$24.95/YD



**ACCORD KOI #45922-0001**  
13.41 oz/sq.yd (repeat H: 3.5" x V: 3.43")

\$39.95/YD

**GREENGUARD® CERTIFIED FOR INDOOR AIR QUALITY**

Sunbrella upholstery fabrics are certified by the GREENGUARD Institute's Children and Schools standard as contributing to healthy indoor air by being a very low emitting interior product.

► [Need a Sample?](#) (details p.11) | Find information on our helpful fabric resources on p.17

◆ Acrylic, PVC, Polyester    ◆ Acrylic, Other    ◆ Acrylic, Polyester





UPHOLSTERY FABRIC

# PATTERNS

Details p.40



**STANTON GREYSTONE #58002-0000** \$22.95/YD  
8.22 oz/sq.yd (repeat H: 8.87")



**ECHO SANGRIA #8080-0000** \$27.95/YD  
9.96 oz/sq.yd

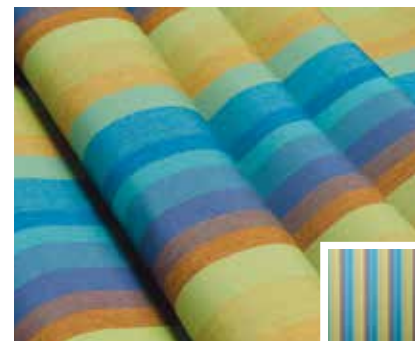

**ASTORIA LAGOON #56096-0000** \$24.95/YD  
8.22 oz/sq.yd (repeat H: 8.87")



**FOSTER SURFSIDE #56049-0000** \$22.95/YD  
8.22 oz/sq.yd (repeat H: 6.75")

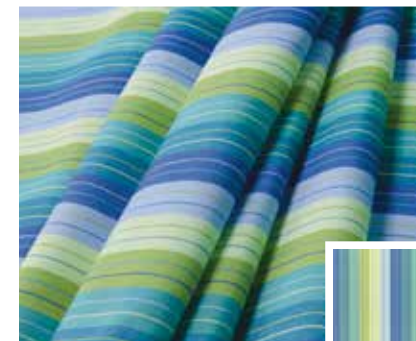

**SEVILLE SEASIDE #5608-0000** \$22.95/YD  
8.22 oz/sq.yd (repeat H: 8.87")

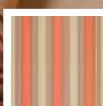

**PASSAGE POPPY #56071-0000** \$24.95/YD  
8.22 oz/sq.yd (repeat H: 8.87")



**BRAVADA LIMELITE #5602-0000** \$24.95/YD  
8.22 oz/sq.yd (repeat H: 6.81")



**VIOLETTA BALTIC #45760-0002** \$45.95/YD  
14.06 oz/sq.yd (repeat H: 28" x V: 26.67")



**SHORE EMERALD #58035-0000** \$24.95/YD  
8.3 oz/sq.yd (repeat H: 1.53")



**HYBRID CITRUS #42076-0000** \$36.95/YD  
◆ 11.6 oz/sq.yd



**MODE LAKESIDE #58006-0000** \$24.95/YD  
9 oz/sq.yd (repeat H: 7.77")



**COVE CAMEO #58037-0000** \$22.95/YD  
8.22 oz/sq.yd (repeat H: 6.79")



**MASON FOREST GREEN #5630-0000** \$22.95/YD  
8.3 oz/sq.yd (repeat H: 2")



**FISCHER LAGOON #45885-0000** \$48.95/YD  
13.87 oz/sq.yd (repeat H: 14" x V: 18")



**CABANA EMERALD #58027-0000** \$24.95/YD  
8.3 oz/sq.yd (repeat H: 6.81")



**REFLEX II CITRON #145095-0000** \$35.95/YD  
10.8 oz/sq.yd (repeat H: 5.6" x V: 10.15")



**ECHO LIMELITE #8078-0000** \$27.95/YD  
9 oz/sq.yd



**TRAVELER LAKESIDE #58007-0000** \$25.95/YD  
9 oz/sq.yd (repeat H: 8.87")



**CAST OASIS #40430-0000** \$21.95/YD  
6.81 oz/sq.yd



**GAVIN MIST #56052-0000** \$22.95/YD  
8.22 oz/sq.yd (repeat H: 6.8")



**BRANNON WHISPER #5621-0000** \$22.95/YD  
8.22 oz/sq.yd (repeat H: 8.88")

► [Need a Sample?](#) (details p.11) | Find information on our helpful fabric resources on p.17

◆ Acrylic, PVC, Polyester   ◆ Acrylic, Other   ◆ Acrylic, Polyester



UPHOLSTERY FABRIC

# PATTERNS

Details p.40



**BINGHAM LAGOON #45789-0001**  
13.3 oz/sq.yd (repeat H: 4.285" x V: 2")

\$40.95/YD



**CABARET BLUE HAZE #45099-0003**  
10.19 oz/sq.yd (repeat H: 28" x V: 28.84")

\$30.95/YD



**DOLCE OASIS #56001-0000**  
8.22 oz/sq.yd (repeat H: 8.9")

\$22.95/YD



**SHORE REGATTA #58032-0000**  
8.22 oz/sq.yd (repeat H: 1.53")

\$24.95/YD

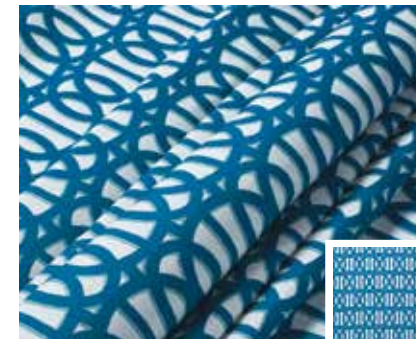

**REFLEX REGATTA #145094-0001**  
10.8 oz/sq.yd (repeat H: 5.6" x V: 10.15")

\$35.95/YD



**ACCORD JADE #45922-0000**  
13.41 oz/sq.yd (repeat H: 3.5" x V: 3.43")

\$39.95/YD



**STANTON LAGOON #58001-0000**  
8.22 oz/sq.yd (repeat H: 8.87")

\$22.95/YD



**TOKEN SURFSIDE #58040-0000**  
9.92 oz/sq.yd (repeat H: 8.84")

\$27.95/YD



**CABANA REGATTA #58029-0000**  
8.22 oz/sq.yd (repeat H: 6.81")

\$24.95/YD

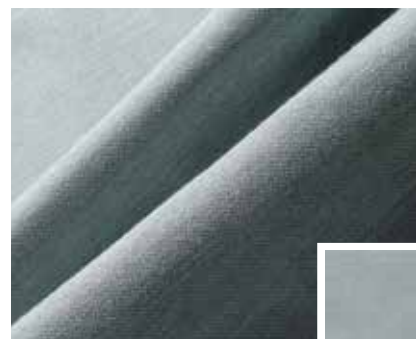

**CAST MIST #40429-0000**  
6.81 oz/sq.yd

\$21.95/YD



**GATEWAY MIST #58039-0000**  
8.22 oz/sq.yd (repeat H: 8.87")

\$22.95/YD



**HYBRID SKY #42078-0000**  
◆ 11.02 oz/sq.yd

\$36.95/YD



**CAST LAGOON #40456-0000**  
6.81 oz/sq.yd

\$21.95/YD



**MILANO COBALT #56080-0000**  
8.22 oz/sq.yd (repeat H: 11.02")

\$24.95/YD



**ECHO MIDNIGHT #8076-0000**  
9.96 oz/sq.yd

\$26.95/YD



**FRETWORK MIST #45991-0000**  
12.51 oz/sq.yd (repeat H: 7" x V: 14.74")

\$39.95/YD



**JUNCTION LAGOON #45510-0005**  
8 oz/sq.yd (repeat H: 3.38" x V: 3.8")

\$37.95/YD



**LANAI LAGOON #45412-0001**  
8 oz/sq.yd (repeat H: 27.13" x V: 29")

\$37.95/YD



**LIDO INDIGO #57004-0000**  
8.6 oz/sq.yd (repeat H: 1.62")

\$22.95/YD

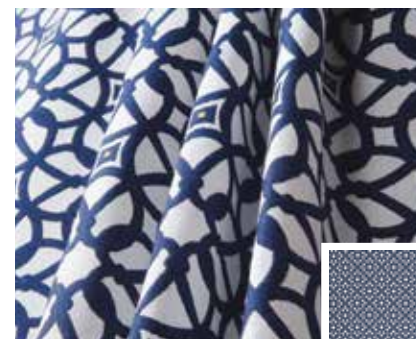

**LUXE INDIGO #45690-0000**  
12.53 oz/sq.yd (repeat H: 7" x V: 6.855")

\$38.95/YD



**VOLT GALAXY #58016-0000**  
9 oz/sq.yd

\$24.95/YD



► [Need a Sample?](#) (details p.11) | Find information on our helpful fabric resources on p.17

◆ Acrylic, PVC, Polyester    ◆ Acrylic, Other    ◆ Acrylic, Polyester



UPHOLSTERY FABRIC

# PATTERNS

Details p.40



**CABANA CLASSIC #58030-0000**  
8.22 oz/sq.yd (repeat H: 6.81")

\$24.95/YD



**ICON MYSTIQUE #58009-0000**  
8 oz/sq.yd (repeat H: 13.56")

\$24.95/YD



**SOLANO SEAGULL #32008-0000**  
13.30 oz/sq.yd (repeat H: 7.65")

\$36.95/YD

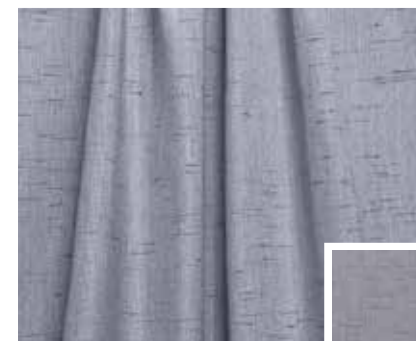

**FREQUENCY ASH #56092-0000**  
8.22 oz/sq.yd

\$22.95/YD



**COVE PEBBLE #58036-0000**  
8.22 oz/sq.yd (repeat H: 6.79")

\$22.95/YD



**PEYTON GRANITE #56075-0000**  
8.6 oz/sq.yd (repeat H: 6.81")

\$25.95/YD



**CAST SILVER #40433-0000**  
6.81 oz/sq.yd

\$21.95/YD



**CAST TINSEL #40435-0000**  
6.81 oz/sq.yd

\$21.95/YD



**ECHO DUNE #57007-0000**  
10.1 oz/sq.yd

\$26.95/YD



**ACTION DENIM #44285-0004**  
9.92 oz/sq.yd

\$35.95/YD

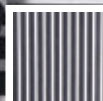

**SHORE CLASSIC #58033-0000**  
8.22 oz/sq.yd (repeat H: 1.53")

\$24.95/YD



**ACTION STONE #44285-0002**  
9.92 oz/sq.yd

\$35.95/YD



**FREQUENCY PARCHMENT #56093-0000**  
8.22 oz/sq.yd

\$22.95/YD



**ECHO ASH #57005-0000**  
10.1oz/sq.yd

\$26.95/YD



**HYBRID SMOKE #42079-0000**  
◆ 11.02 oz/sq.yd

\$36.95/YD



**BERENSON TUXEDO #8521-0000**  
9.1 oz/sq.yd (repeat H: 4.5")

\$24.95/YD



**MILANO CHARCOAL #56079-0000**  
8.22 oz/sq.yd (repeat H: 11.02")

\$22.95/YD

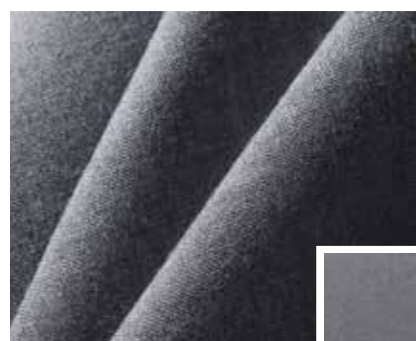

**CAST SLATE #40434-0000**  
6.81 oz/sq.yd

\$21.95/YD



**ACTION ASH #44285-0001**  
9.92 oz/sq.yd

\$35.95/YD



**VOLT SILVER #58020-0000**  
9 oz/sq.yd

\$24.95/YD



## WORRY FREE!

Sunbrella fabric resists stains and fading, so you can stop worrying about your fabric and enjoy life.

► [Need a Sample?](#) (details p.11) | Find information on our helpful fabric resources on p.17

◆ Acrylic, PVC, Polyester   ◆ Acrylic, Other   ◆ Acrylic, Polyester



A #3032610 B #3034291 C #3025705

# GEOBELLA

## BY PHIFER

Beautiful earth-friendly, fade resistant, indoor/outdoor designer fabric made of 100% olefin yarns (recycled from post-industrial waste). Lightweight yet extremely strong and durable, passing all industry standards for the cushion market under TCFFA guidelines. Moisture-wicking, quick drying, and resistant to mold and mildew growth.

**SEWING:** See Thread & Needle Recommendations p.245 **MATERIAL:** 100% recycled olefin yarn **WIDTH:** 54" **WEIGHT:** 5.5 - 9 oz. per square yard

**SALE UNIT:** Sold per linear yard

### RECOMMENDED FOR:



Upholstery projects, pillows, boat interiors, outdoor cushions and patio furniture.

► [Need a Sample?](#) (details p.11) | Find information on our helpful fabric resources on p.17



**ROCK SOLID MARZIPAN #3025705** \$22.95/YD  
5.9 oz/sq.yd



**JUNGLE BEAT LAGOON #3025724** \$29.95/YD  
8.6 oz/sq.yd (repeat H: 27" x V: 27")

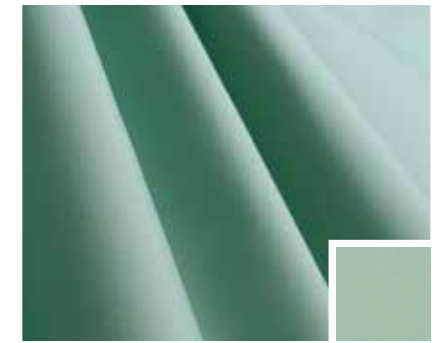

**ROCK SOLID LAGOON #3027694** \$22.95/YD  
5.9 oz/sq.yd



**ROCK SOLID SAGE #3025693** \$22.95/YD  
5.9 oz/sq.yd



**LUCIA SEAGLASS #3030846** \$25.95/YD  
7.3 oz/sq.yd (repeat H: 6.54" x V: 4.6")



**CONCORDIA WILLOW #3034289** \$24.95/YD  
7.2 oz/sq.yd (repeat H: 3.27" x V: 3.66")



**MELROSE WILLOW # 3034291** \$28.95/YD  
9 oz/sq.yd (repeat H: 8.67" x V: 13")



**MANDALAY BAY WILLOW #3034290** \$28.95/YD  
9 oz/sq.yd (repeat H: 14.5" x V: 13.06")

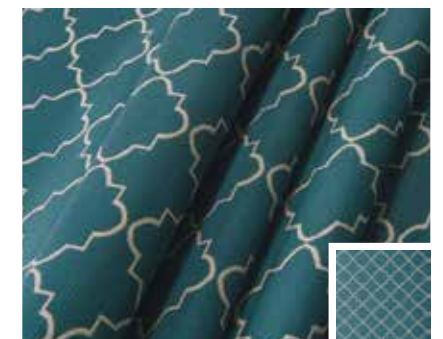

**ST. CROIX PEACOCK #3032610** \$24.95/YD  
7.2 oz/sq.yd (repeat H: 4" x V: 3.5")



**BISTRO STRIPE WILLOW #3034288** \$20.95/YD  
6.2 oz/sq.yd (repeat V: 4.8")



**MEHINDI CORNFLOWER #3029139** \$28.95/YD  
8.6 oz/sq.yd (repeat H: 13.5" x V: 27")



**BALLY CASTLE SEA #3025726** \$28.95/YD  
8.6 oz/sq.yd (repeat H: 14" x V: 14")



**NANTUCKET NAVY #3032538** \$25.95/YD  
7.3 oz/sq.yd (repeat H: 28" x V: 27")



**ROCK SOLID NAVY #3025695** \$20.95/YD  
5.9 oz/sq.yd

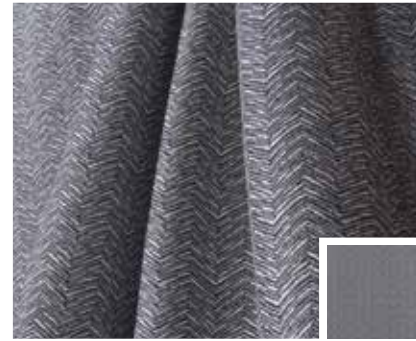

**BIJOU NAVY #3032614** \$25.95/YD  
7.2 oz/sq.yd (repeat H: 3.6" x V: 2.4")

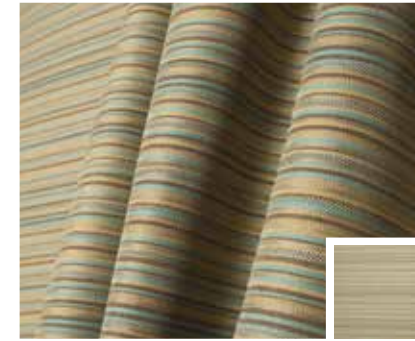

**FULANI SAGE #3024092** \$20.95/YD  
5.5 oz/sq.yd (repeat V: 6")



**SAUSALITO GRASS GREEN #3032511** \$21.95/YD  
5.5 oz/sq.yd (repeat V: 9.25")

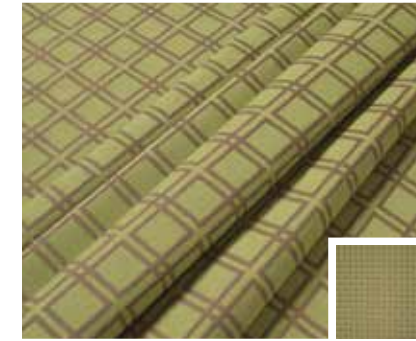

**LABYRINTH GRASS GREEN #3032513** \$25.95/YD  
7.3 oz/sq.yd (repeat H: 3.5" x V: 3.9")



**BOMBAY NAVY #3032504** \$26.95/YD  
7.3 oz/sq.yd (repeat H: 13.5" x V: 13.5")



**ST. CROIX NAVY #3032609** \$24.95/YD  
7.2 oz/sq.yd (repeat H: 4" x V: 3.5")



**MOMENTUM INDIGO #3034296** \$25.95/YD  
7.3 oz/sq.yd (repeat H: 4.6" x V: 2.5")

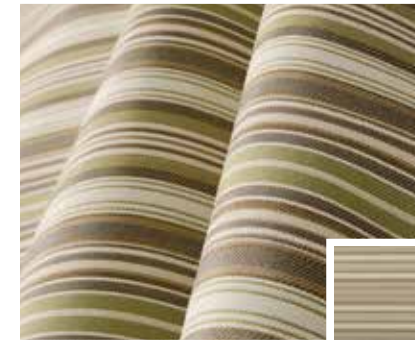

**EMERY STRIPE VERDE #3034293** \$24.95/YD  
7.2 oz/sq.yd (repeat V: 4.5")

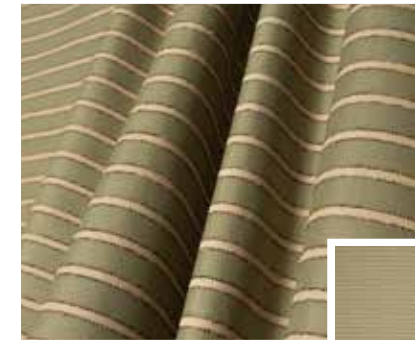

**BURTON MARSH #3027686** \$19.95/YD  
6.2 oz/sq.yd (repeat V: 0.9375")

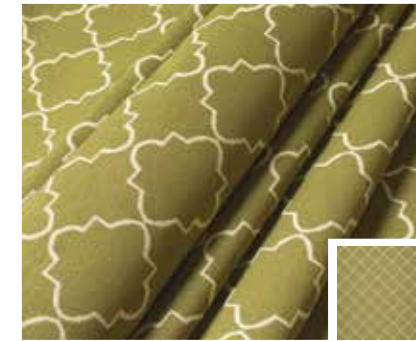

**ST. CROIX OLIVE GREEN #3032611** \$24.95/YD  
7.2 oz/sq.yd (repeat H: 4" x V: 3.5")



**ANASTASIA PEACOCK #3032535** \$28.95/YD  
9 oz/sq.yd (repeat H: 27" x V: 27")



**MADIERA VERDE #3034292** \$25.95/YD  
7.3 oz/sq.yd (repeat H: 4.5" x V: 5.3")



**ROCK SOLID TARRAGON #3025703** \$22.95/YD  
5.9 oz/sq.yd



**SAUSALITO PEACOCK #3030853** \$20.95/YD  
5.5 oz/sq.yd (repeat V: 9.25")



**ROCK SOLID OCHRE #3025714** \$22.95/YD  
5.9 oz/sq.yd



**CONCORDIA TOPAZ #3034286** \$24.95/YD  
7.2 oz/sq.yd (repeat H: 3.27" x V: 3.66")



**FLORA GRASS GREEN #3032512** \$25.95/YD  
7.3 oz/sq.yd (repeat H: 28" x V: 13.5")



**KILKENNY LAGOON #3029149** \$29.95/YD  
9 oz/sq.yd (repeat H: 27" x V: 14")



**WHITMAN SAGE #3027681** \$30.95/YD  
5.9 oz/sq.yd (repeat V: 5.05")



**TANSY ORCHID #3034295** \$25.95/YD  
7.3 oz/sq.yd (repeat H: 28" x V: 23")



**HOBNOB MIST #3025696** \$22.95/YD  
5.9 oz/sq.yd



**FIRE DANCE BISQUE #3030866** \$25.95/YD  
7.3 oz/sq.yd (repeat H: 6.75" x V: 7")

► [Need a Sample?](#) (details p.11) | Find information on our helpful fabric resources on p.17



**DHURRIE SCARLET #3034300**  
\$28.95/YD  
8.6 oz/sq.yd (repeat H: 4.5" x V: 3")



**FRESH CUT TANGO #3030859**  
\$24.95/YD  
7.2 oz/sq.yd (repeat H: 3.625" x V: 3.375")



**ROCK SOLID TANGO #3025708**  
\$22.95/YD  
5.9 oz/sq.yd

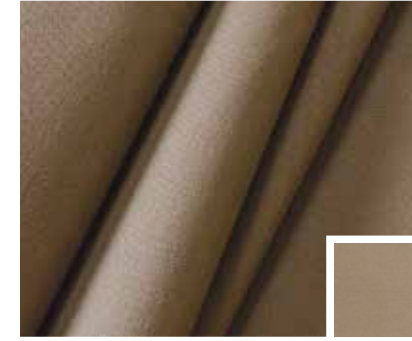

**ROCK SOLID WALNUT #3025700**  
\$22.95/YD  
5.9 oz/sq.yd



**ISHA SHITAKE #3030865**  
\$24.95/YD  
7.3 oz/sq.yd (repeat H: 3.3" x V: 4.15")



**BIJOU BISCOTTI #3032615**  
\$25.95/YD  
7.2 oz/sq.yd (repeat H: 3.6" x V: 2.4")



**SASCHA BERRY #3032544**  
\$25.95/YD  
7.3 oz/sq.yd (repeat H: 27" x V: 28")



**FIRE DANCE CLAY #3030861**  
\$25.95/YD  
7.3 oz/sq.yd (repeat H: 6.75" x V: 7")



**HARMONIC SPICE #3024098**  
\$22.95/YD  
6.7 oz/sq.yd



**FLORA SHITAKE #3030862**  
\$24.95/YD  
7.3 oz/sq.yd (repeat H: 28" x V: 13.5")



**ROCK SOLID SHITAKE #3032514**  
\$20.95/YD  
5.9 oz/sq.yd



**MANDALAY BAY SEPIA #3034287**  
\$28.95/YD  
9 oz/sq.yd (repeat H: 14.5" x V: 13.06")



**CANVAS TAN #3030851**  
\$21.95/YD  
6 oz/sq.yd

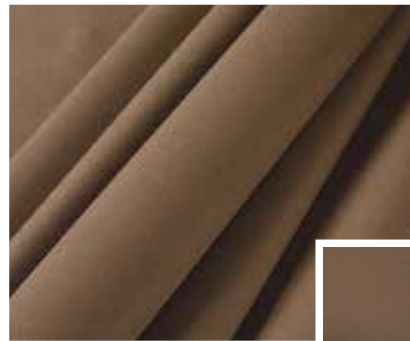

**GRAHAM SHITAKE #3032532**  
\$21.95/YD  
6 oz/sq.yd



**CADENCE MINK #3030863**  
\$24.95/YD  
7.3 oz/sq.yd (repeat H: 1.2" x V: 1.2")



**CONCORDIA MINK #3034294**  
\$24.95/YD  
7.2 oz/sq.yd (repeat H: 3.27" x V: 3.66")



**ZEAL SLATE #3029134**  
\$21.95/YD  
7.2 oz/sq.yd (repeat H: 0.125" x V: 0.125")



**ROCK SOLID DRIFTWOOD #3034298**  
\$20.95/YD  
5.9 oz/sq.yd

**WHAT IS OLEFIN?**

Olefin is an environmentally friendly, synthetic fiber known for its durability and strength. It wicks moisture and dries quickly and is resistant to stains, mildew, fading and chemicals making it a great durable choice for hard-wearing applications.

Woven Olefin fabrics are great for boat interiors as well as patio cushions and home upholstery.



**HOBNOB FOG #3025707**  
\$22.95/YD  
5.9 oz/sq.yd



**HOUNDSTOOTH #3025669**  
\$25.95/YD  
7.3 oz/sq.yd (repeat H: 1.2" x V: 1.25")



**ROCK SOLID BLACK #3025706**  
\$22.95/YD  
5.9 oz/sq.yd

New!

## W-1 HAND PRESS

# PROFESSIONALLY SET GROMMETS & FASTENERS

Improve your speed and consistency with the W-1 Hand Press by C.S. Osborne. This easy-to-use press cuts holes for and installs spur grommets and vent grommets as well as ligne 24 snap fasteners and oversized grommets. It also cuts fabric and covers buttons for upholstery work. Dies are sold separately from the tool so you can customize the perfect set.

Learn more at [Sailrite.com](http://Sailrite.com).

### SPUR GROMMET DIE SET & HOLE CUTTERS

- #0 (1/4") #120743 \$62.95 EA
- #1 (5/16") #120744 \$62.95 EA
- #2 (3/8") #120745 \$63.95 EA
- #3 (7/16") #120746 \$64.95 EA
- #4 (1/2") #121281 \$65.95 EA
- #5 (5/8") #121282 \$67.95 EA

### PLAIN GROMMET DIE SET & HOLE CUTTER

- #12 (1-9/16") #121275 \$89.95 EA
- #15 (2") #121276 \$101.95 EA

### VENTILATOR DIE SET & HOLE CUTTER

- 3/4" #120740 \$63.95 EA
- 1" #120741 \$67.95 EA

### BUTTON COVER DIE SET & HOLE CUTTER

- #30 (3/4") #121392 \$78.95 EA
- #36 (7/8") #121393 \$98.95 EA
- #45 (1-1/8") #121394 \$123.95 EA

W-1 HAND PRESS

#121274

\$162.95 EA



## ULTRASUEDE® HP BY TORAY



The beauty and softness of suede with the performance of ultra-microfiber! Made from recycled polyester, Ultr suede is designed to be both eco-friendly and high quality. It is comfortable in any climate, easy to clean and won't sag, shrink or lose its shape. Plus Ultr suede boasts outstanding durability and abrasion resistance (200,000 double rubs!). Choose Ultr suede for a luxurious, comfortable cabin. **\$99.00/YD**

**SEWING:** See Thread & Needle Recommendations p.245

**MATERIAL:** 80% Non-Woven Polyester, 20% Non-Fibrous Polyurethane Binder

**WIDTH:** 55" **WEIGHT:** 11.1 oz. per square yard **THICKNESS:** 1 mm **SALE UNIT:** Sold per linear yard

**RECOMMENDED FOR:** Yacht interiors, cushions and upholstery projects

Please note, Ultr suede® is non-returnable.



► Need a Sample? (details p11) | Find information on our helpful fabric resources on p.17



▲ **FREE VIDEO: "How to Make a Companionway Cover"**  
 Watch at [Sailrite.com](http://Sailrite.com) (#X-HT-200579)

**FREE VIDEO: "How to Make a Boat Windshield Sun Shade"** ▶  
 Watch at [Sailrite.com](http://Sailrite.com) (#X-HT-300111)

# PHIFERTEX® & PHIFERTEX PLUS

A designer mesh fabric with excellent dimensional stability and flexibility in all climates. Phifertex (p.77) provides a 70% shade factor but also allows good light infiltration when used as a window covering. With a tighter weave, Phifertex Plus (p.75) offers a 90–95% shade factor and very good privacy. Use as a window covering to extend the life of vinyl window and also allow for some interior light.

**SEWING:** See Thread & Needle Recommendations p.245 **MATERIAL:** Vinyl encapsulated polyester yarns

**WIDTH:** 54" **SALE UNIT:** Sold per linear yard **RECOMMENDED FOR:** Boat enclosures, structural awnings, RV and yacht window covers and roller shades. Phifertex Plus is also a great choice for boat cockpit cushions when used with quick dry foam, sling chairs and patio furniture.

### ACTUAL SIZE OF WEAVE

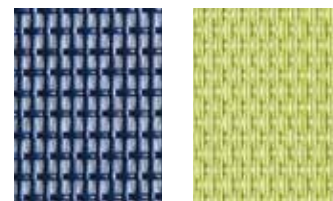











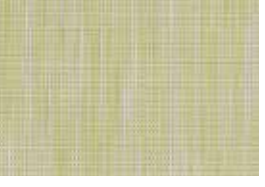
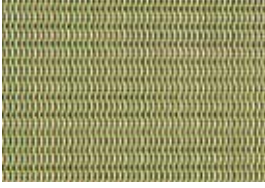





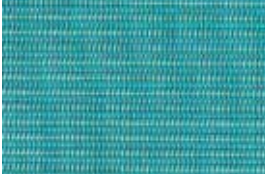
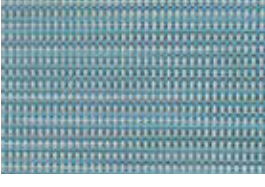
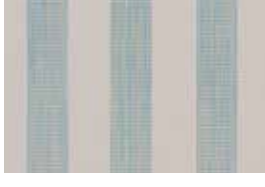
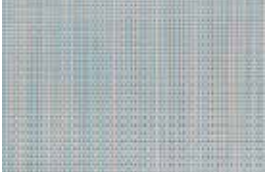



Phifertex

Phifertex Plus

► [Need a Sample?](#) (details p.11) | Find information on our helpful fabric resources on p.17

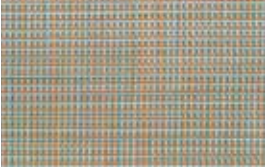
## PHIFERTEX® PLUS 16 oz. per square yard | Details p.74

	<b>GARDEN GREEN</b> #3013966 (repeat H: 3.5") 1-14 yds \$18.95/YD 15-59 yds \$18.00/YD 60+ yds \$17.06/YD		<b>BAILEY STRIPE CITRONELLE</b> #3035592 (repeat H: 6") 1-14 yds \$20.95/YD 15-59 yds \$19.90/YD 60+ yds \$18.86/YD		<b>SPRING TWEED CITRONELLE</b> #3035590 1-14 yds \$20.95/YD 15-59 yds \$19.90/YD 60+ yds \$18.86/YD
	<b>DUPIONE KIWI</b> #103004 1-14 yds \$20.95/YD 15-59 yds \$19.90/YD 60+ yds \$18.86/YD		<b>DELRAY STRIPE KIWI</b> #103001 (repeat H: 3.5") 1-14 yds \$20.95/YD 15-59 yds \$19.90/YD 60+ yds \$18.86/YD		<b>HOLLY GREEN</b> #124211 1-14 yds \$18.95/YD 15-59 yds \$18.00/YD 60+ yds \$17.06/YD
	<b>RALEIGH STRIPE WILLOW</b> #3034327 (repeat H: 6.7") 1-14 yds \$20.95/YD 15-59 yds \$19.90/YD 60+ yds \$18.86/YD		<b>STRAW MAT BLUE</b> #3032480 (repeat H: 3.5") 1-14 yds \$20.95/YD 15-59 yds \$19.90/YD 60+ yds \$18.86/YD		<b>TRIXIE STRIPE MYRTLE</b> #3034328 (repeat H: 6.7") 1-14 yds \$20.95/YD 15-59 yds \$19.90/YD 60+ yds \$18.86/YD
	<b>NEW METALLICA LAGOON</b> #3036949 1-14 yds \$20.95/YD 15-59 yds \$19.90/YD 60+ yds \$18.86/YD		<b>NEW MADRAS TWEED SURF</b> #3036892 1-14 yds \$20.95/YD 15-59 yds \$19.90/YD 60+ yds \$18.86/YD		<b>BAILEY STRIPE AQUA SHIMMER</b> #3035593 (repeat H: 6") 1-14 yds \$20.95/YD 15-59 yds \$19.90/YD 60+ yds \$18.86/YD
	<b>SPRING TWEED AQUA SHIMMER</b> #3035591 1-14 yds \$20.95/YD 15-59 yds \$19.90/YD 60+ yds \$18.86/YD		<b>NEW OWEN STRIPE SURF</b> #3036895 (repeat H: 9.5") 1-14 yds \$20.95/YD 15-59 yds \$19.90/YD 60+ yds \$18.86/YD		<b>DUPIONE POOLSIDE</b> #103003 1-14 yds \$20.95/YD 15-59 yds \$19.90/YD 60+ yds \$18.86/YD
	<b>DELRAY STRIPE POOLSIDE</b> #103002 (repeat H: 1.75") 1-14 yds \$20.95/YD 15-59 yds \$19.90/YD 60+ yds \$18.86/YD		<b>TWEED INDIGO</b> #3034309 1-14 yds \$20.95/YD 15-59 yds \$19.90/YD 60+ yds \$18.86/YD		<b>NEW PALAZZO STRIPE HARBOR</b> #3036894 (repeat H: 11.375") 1-14 yds \$20.95/YD 15-59 yds \$19.90/YD 60+ yds \$18.86/YD
	<b>NAVY PIER</b> #2360 1-14 yds \$18.95/YD 15-59 yds \$18.00/YD 60+ yds \$17.06/YD		<b>DUPIONE SAPPHIRE</b> #3029023 1-14 yds \$20.95/YD 15-59 yds \$19.90/YD 60+ yds \$18.86/YD		<b>ROYAL BLUE</b> #2361 1-14 yds \$18.95/YD 15-59 yds \$18.00/YD 60+ yds \$17.06/YD
	<b>WINSTED STRIPE BEACH</b> #3032476 (repeat H: 6.7") 1-14 yds \$20.95/YD 15-59 yds \$19.90/YD 60+ yds \$18.86/YD		<b>TWEED TAFFY</b> #3034308 1-14 yds \$20.95/YD 15-59 yds \$19.90/YD 60+ yds \$18.86/YD		<b>SNAPPY</b> #3013965 1-14 yds \$18.95/YD 15-59 yds \$18.00/YD 60+ yds \$17.06/YD



**PHIFERTEX® PLUS** 16 oz. per square yard | Details p.74



◀ ACTUAL SIZE OF WEAVE



**LEMON YELLOW #3007147**

1-14 yds \$18.95/YD  
15-59 yds \$18.00/YD  
60+ yds \$17.06/YD



**SALSA #3013967**

1-14 yds \$18.95/YD  
15-59 yds \$18.00/YD  
60+ yds \$17.06/YD

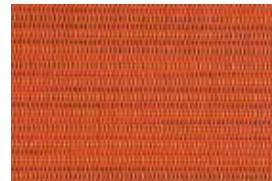

**METALLIC SALSA #3018436**

1-14 yds \$18.95/YD  
15-59 yds \$18.00/YD  
60+ yds \$17.06/YD



**DUPIONE SPICE #3029022**

1-14 yds \$20.95/YD  
15-59 yds \$19.90/YD  
60+ yds \$18.86/YD



**STRAW MAT COGNAC #3007506**

1-14 yds \$20.95/YD  
15-59 yds \$19.90/YD  
60+ yds \$18.86/YD



**BURLAP #3016019**

1-14 yds \$18.95/YD  
15-59 yds \$18.00/YD  
60+ yds \$17.06/YD



**MARTINDALE PEWTER #3032478**  
(repeat H: 3.375")

1-14 yds \$20.95/YD  
15-59 yds \$19.90/YD  
60+ yds \$18.86/YD



**SAYLOR STRIPE SEPIA #3034326**  
(repeat H: 13.5")

1-14 yds \$20.95/YD  
15-59 yds \$19.90/YD  
60+ yds \$18.86/YD



**NEW VINYARD STRIPE COPPER #3036896**  
(repeat H: 6")

1-14 yds \$20.95/YD  
15-59 yds \$19.90/YD  
60+ yds \$18.86/YD



**NEW SPRING TWEED COPPER #3036891**

1-14 yds \$20.95/YD  
15-59 yds \$19.90/YD  
60+ yds \$18.86/YD



**STUCCO #1238**

1-14 yds \$18.95/YD  
15-59 yds \$18.00/YD  
60+ yds \$17.06/YD



**SAND #1243**

1-14 yds \$18.95/YD  
15-59 yds \$18.00/YD  
60+ yds \$17.06/YD

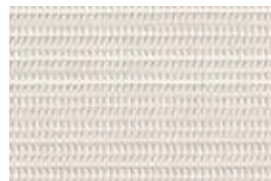

**METALLICA WHITE #3032475**

1-14 yds \$20.95/YD  
15-59 yds \$19.90/YD  
60+ yds \$18.86/YD



**WHITE #2358**

1-14 yds \$18.95/YD  
15-59 yds \$18.00/YD  
60+ yds \$17.06/YD



**NEW SPRING TWEED SILVER #3036893**

1-14 yds \$20.95/YD  
15-59 yds \$19.90/YD  
60+ yds \$18.86/YD

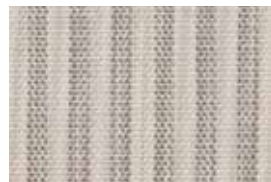

**NEW VINEYARD STRIPE SILVER #3036897**  
(repeat H: 6")

1-14 yds \$20.95/YD  
15-59 yds \$19.90/YD  
60+ yds \$18.86/YD

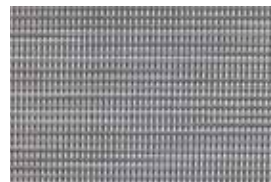

**NEW MADRAS TWEED HARBOR #3036890**

1-14 yds \$20.95/YD  
15-59 yds \$19.90/YD  
60+ yds \$18.86/YD



**METALLICA PLATINUM #3025678**

1-14 yds \$20.95/YD  
15-59 yds \$19.90/YD  
60+ yds \$18.8/YD



**METALLIC SMOKE #3027626**

1-14 yds \$20.95/YD  
15-59 yds \$19.90/YD  
60+ yds \$18.86/YD



**BLACK #124511**

1-14 yds \$18.95/YD  
15-59 yds \$18.00/YD  
60+ yds \$17.06/YD

**PHIFERTEX®** 11.3 oz. per square yard | Details p.74



◀ ACTUAL SIZE OF WEAVE

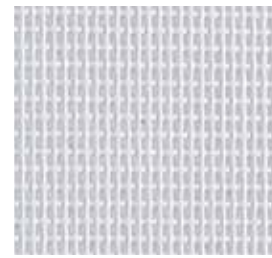

**WHITE #393**

1-14 yds \$13.95/YD  
15-59 yds \$13.25/YD  
60+ yds \$12.56/YD

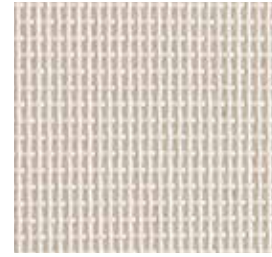

**ALMOND #390**

1-14 yds \$13.95/YD  
15-59 yds \$13.25/YD  
60+ yds \$12.56/YD

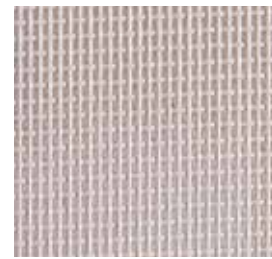

**SAND #416**

1-14 yds \$13.95/YD  
15-59 yds \$13.25/YD  
60+ yds \$12.56/YD

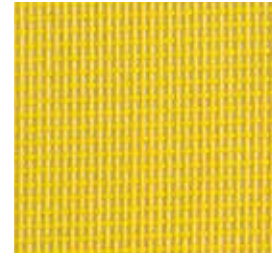

**LEMON YELLOW #397**

1-14 yds \$13.95/YD  
15-59 yds \$13.25/YD  
60+ yds \$12.56/YD

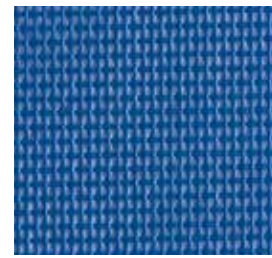

**ROYAL BLUE #394**

1-14 yds \$13.95/YD  
15-59 yds \$13.25/YD  
60+ yds \$12.56/YD



**FREE VIDEO: "How to Make Sailboat Sheet Bags"**  
Watch at Sailrite.com (#X-HT-300117)

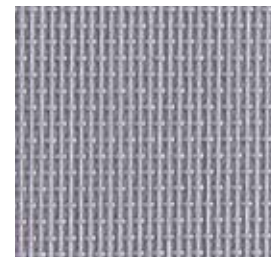

**GREY #391**

1-14 yds \$13.95/YD  
15-59 yds \$13.25/YD  
60+ yds \$12.56/YD



**ORANGE #400412**

1-14 yds \$13.95/YD  
15-59 yds \$13.25/YD  
60+ yds \$12.56/YD

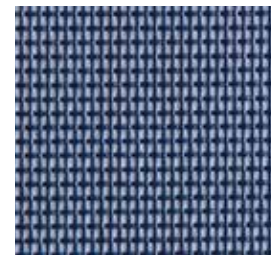

**NAVY BLUE #395**

1-14 yds \$13.95/YD  
15-59 yds \$13.25/YD  
60+ yds \$12.56/YD

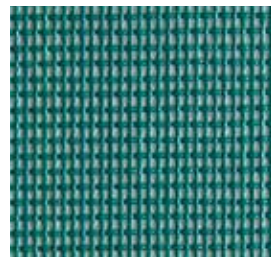

**SPRUCE GREEN #392**

1-14 yds \$13.95/YD  
15-59 yds \$13.25/YD  
60+ yds \$12.56/YD

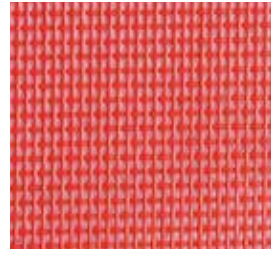

**CHRISTMAS RED #410123**

1-14 yds \$13.95/YD  
15-59 yds \$13.25/YD  
60+ yds \$12.56/YD

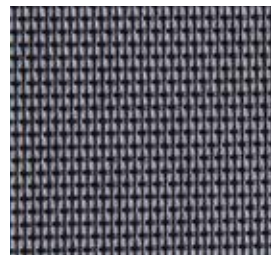

**BLACK #388**

1-14 yds \$13.95/YD  
15-59 yds \$13.25/YD  
60+ yds \$12.56/YD



FREE VIDEO: "How to Replace Boat Carpet with Woven Flooring"  
Watch at [Sailrite.com](https://www.sailrite.com) (#X-HT-200674)



**EASILY BIND THE EDGES OF YOUR FLOORING WITH A 1-1/4" BINDER**

Both Infinity and Chilewich are perfect for snap-in mats. Binding the edges of your woven vinyl flooring is easy with our 1-1/4" Binder Attachment, which was specially designed with these materials in mind. See more on p.123.

## CHILEWICH FLOOR COVERING

Durable and stylish, Chilewich Floor Covering is an innovative blend of vinyl and fiberglass with a 100% polyurethane backing that is perfect for marine mats, boat carpeting, placemats, shelf liners and coasters. Contains Microban® to inhibit growth of mold, mildew and bacteria. Chilewich is colorfast, stain resistant, and easy to clean. Plus it cuts without fraying and is easy to sew.

**RECOMMENDED FOR**



Snap-in marine mats, boat carpeting, patio & outdoor rugs, placemats and coasters.

**SEWING:** See Thread & Needle Recommendations on p.245

**MATERIAL:** Vinyl & fiberglass blend with polyurethane backing

**WIDTH:** 72"

**WEIGHT:** 49.5 - 54 oz. per square yard

**THICKNESS:**

A. 0.135"

B. 0.145"

**SALE UNIT:** Sold per linear yard

*Please note, Chilewich Floor Coverings are non-returnable.*



**A. IKAT STONE\***  
#106734

\$109.95/YD



**A. IKAT TWEED\***  
#106733

\$109.95/YD



**B. BASKETWEAVE OYSTER\***  
#106735

\$127.95/YD

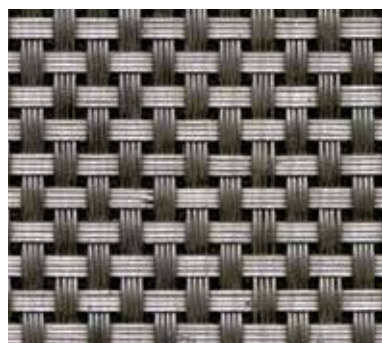

**B. BASKETWEAVE TITANIUM\***  
#106736

\$127.95/YD

\* Actual Size

► [Need a Sample?](#) (details p.11) | Find information on our helpful fabric resources on p.17

## INFINITY LUXURY WOVEN VINYL

Stylish and unique woven flooring for your boat, home or RV. Infinity flooring features a woven vinyl top with a "frothed vinyl" backing and is UV-stable, quick drying and low maintenance. The woven top stands up to heavy traffic and is soft underfoot and antimicrobial. Backing grips in place without fusing to your deck or causing damage. Can be snapped or glued in place.

**RECOMMENDED FOR**



Snap-in marine mats, boat carpeting, RV treads, swim platforms, placemats, decorative wall panels, and patio rugs.

**SEWING:** See Thread & Needle Recommendations on p.245

**MATERIAL:** Vinyl with frothed vinyl memory backing

**WIDTH:** 102"

**WEIGHT:** 45.5 oz. per square yard

**THICKNESS:** 0.115" - 0.146"

**WARRANTY:** 10 year limited manufacturers

**SALE UNIT:** Sold per linear yard

*Please note, Infinity Luxury Woven Vinyl is non-returnable.*

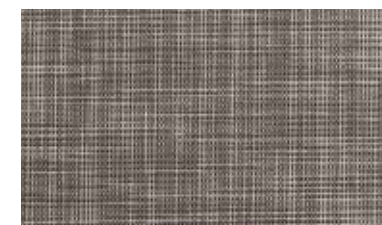

**CHARCOAL**  
#120225

\$189.95/YD



**GREY**  
#120224

\$189.95/YD



**BEIGE**  
#120226

\$189.95/YD



**SEAGRASS SANDSTONE**  
#120223

\$263.95/YD



**LIGHT TEAK**  
#120222

\$263.95/YD



**DARK TEAK**  
#120219

\$263.95/YD

► [Need a Sample?](#) (details p.11) | Find information on our helpful fabric resources on p.17

# RIPSTOP SPINNAKER CLOTH

The standard for spinnaker and drifter fabric. Controlled stretch and remarkable durability in use and storage.

## A RIPSTOP 0.5 OZ.:

Lightweight. Coated for low stretch, zero porosity, high tensile and durability.  
\$14.95/YD

## B RIPSTOP 0.75 OZ.:

Lightweight, low stretch, and stabilized finish with maximum fibers per weight for excellent durability.  
\$11.95/YD

## C RIPSTOP 1.5 OZ.:

Heavyweight and stabilized finish with maximum fibers for durability.  
\$9.95/YD

**MATERIAL:** Nylon  
**WIDTH:** 60"  
**SALE UNIT:** Sold per linear yard



# NYLON BAG & FLAG CLOTH BY SOLARMAX®

Brightly colored Type 66 standard nylon material designed for flags and bags. Relatively strong but not suitable for covers or sails because of low UV and stretch resistance.

## A 4 OZ. NYLON FLAG CLOTH

Recommended for flags, banners, and light bags. Refer to *Make Your Own Courtesy or Signal Flags* (#39056, p.244) for instructions. 200 denier. Width: 60".  
\$6.95/YD

## B 8 OZ. NYLON BAG CLOTH

Recommended for sturdy bags, sail bags, or banners. 400 denier. Width: 62".  
\$9.95/YD

**SEWING:** See Thread & Needle Recommendations p.245  
**MATERIAL:** Nylon  
**SALE UNIT:** Sold per linear yard

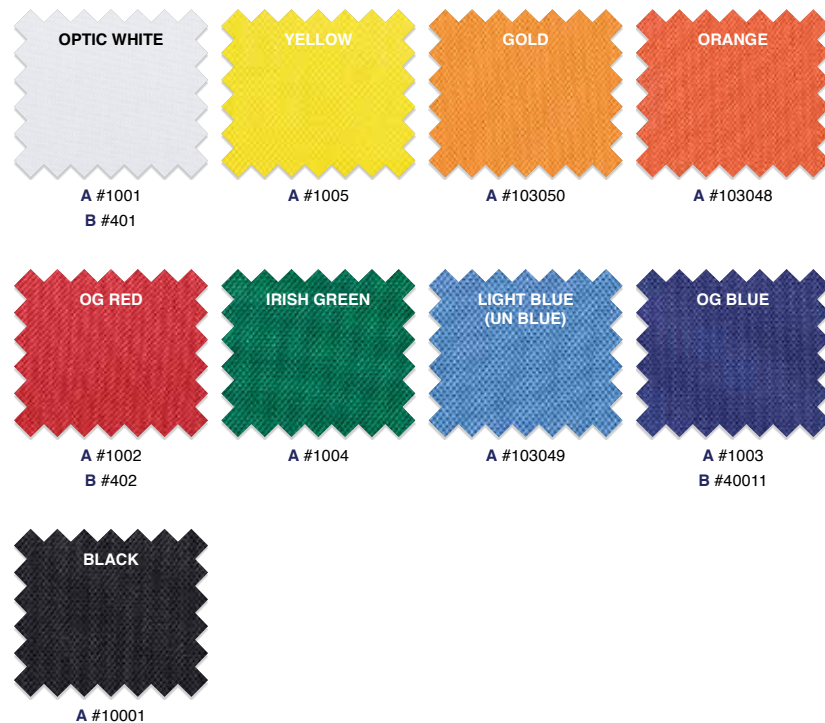

## BAG & FLAG HARDWARE

p.181 & 183

► [Need a Sample?](#) (details p.11)



# ALL-PURPOSE DACRON\*

All purpose sailcloth used for Daysailors, beach cats, Windsurfers, dinghies, and light air sails on larger boats. Good durability and excellent tear strength. Medium firm. Dye lot color may vary. Sold per linear yard.

COLOR	WEIGHT	WIDTH	PART #	PRICE
A White	4 oz.	36"	#926	\$9.95/YD
White	4 oz.	58"	#101023	\$11.95/YD
B Cream	4 oz.	36"	#938	\$16.95/YD
C Yellow	4 oz.	36"	#920	\$15.95/YD
D Storm Orange	9 oz.	54"	#100401	\$25.95/YD
E Red	4 oz.	36"	#917	\$15.95/YD
F Dark Blue	4 oz.	36"	#91800	\$15.95/YD
G Green	4 oz.	36"	#922	\$15.95/YD
H Black	4 oz.	36"	#925	\$15.95/YD
I Tanbark	4 oz.	36"	#937100	\$17.95/YD

\*Dacron® is a registered trademark of DuPont. Most sails are made of Dacron, a manufactured fiber more generically referred to as polyester. Sailcloth weight is calculated from the weight (oz.) of a 36" x 28.5" piece.

► [Need a Sample?](#) (details p.11)

# SUPERCUISE DACRON\* BY CONTENDER

Maximum durability and respectable performance at a reasonable price. Quality weave with high mass warp yarns (over 7 oz.) which provide UV, tear, and abrasion resistance. Balanced weave (some yarn crimp in both warp and fill) so less resin is required to maintain shape. Relatively soft hand. Sold per linear yard.

COLOR	WEIGHT	WIDTH	PART #	PRICE
White	4.4 oz.	54"	#100132	\$13.95/YD
White	5.4 oz.	54"	#100138	\$16.95/YD
White	6.4 oz.	54"	#100192	\$16.95/YD
White	7.4 oz.	54"	#100195	\$17.95/YD
White	8.4 oz.	54"	#100165	\$19.95/YD
White	9.4 oz.	54"	#100205	\$20.95/YD
White	10.4 oz.	54"	#100209	\$21.95/YD

# UV COATED 5.5 OZ. DACRON\*

Add strength and UV protection to your sails with a UV sacrificial cover. Also great for awnings. Knife coated with a urethane that is impregnated with Titanium Dioxide-Plus and white pigment. Coated on both sides. White. Width: 54". Sold per linear yard.

#120385 \$23.95/YD



## TARGA PREMIUM CANOPY

A tough, durable fabric ready for printing with logos and graphics. Targa Premium Canopy fabric is a 100% polyester, fire resistant fabric that is coated on both sides for solvent-based inks or UV ink digital coating applications. Low stretch and high strength. UV resistant and can also be used for UV sacrificial covers on sails. FR Certified: NFPA 701, CAL TITLE 19.

White 60" #106928 \$23.95/YD

**RECOMMENDED FOR:** Banners, UV sacrificial covers, awnings and canopies

**SEWING:** See Thread & Needle Recommendations p.245 **MATERIAL:** 100% polyester  
**WIDTH:** 60" **WEIGHT:** 6.7 oz. per square yard **SALE UNIT:** Sold per linear yard

## AIRX 700 PREMIUM SPINNAKER CLOTH

Premium nylon spinnaker fabric that combines unprecedented strength, performance and quality. Exceptional burst and tear strength allows lighter sails to be used in higher wind ranges. Used by more Grand Prix racers than any other spinnaker cloth. White.

#100453 \$19.95/YD

**RECOMMENDED FOR:**

Racing spinnakers and model boats

**MATERIAL:** Nylon **WIDTH:** 60" **WEIGHT:** 1.1 oz. **SALE UNIT:** Sold per linear yard

## SAILMAKER'S LEATHER

Chrome-tanned leather that functions as great chafe protection. Anionic dye/pigment for gray color. The Chrome leather (#559) features a smooth side, less stretch, and heavier weight making it perfect for high wear areas. Easy to sew by hand or machine.

**RECOMMENDED FOR:**

Chafe protection for sail corners and covers and for small wheel or turnbuckle covers

**SALE UNIT:** Sold per square foot  
(12" x 12" split cowhide, often not square or exact)

**a** 4-5 oz. Chrome Pearl Grey #559 \$15.95/SQ FT

**b** 2-3 oz. Pearl Grey #28301 \$8.95/SQ FT

**c** 4.5 oz. Pearl Grey #2349 \$10.95/SQ FT



## ADHESIVE-BACKED INSIGNIA MATERIAL

High tack, residue free, adhesive-backed polyester material. No sewing required when applied to sailcloth! Simple and easy to use.

**RECOMMENDED FOR:** Economical repair tape, spreader patches, sail numbers and logos

**MATERIAL:** Polyester

**WIDTH:** 54"

**WEIGHT:** 4.19 oz.

**SALE UNIT:** Sold per linear yard

**A** Green #104308 \$16.95/YD

**B** Blue #1070 \$16.95/YD

**C** Red #943 \$16.95/YD

**D** Black #946 \$16.95/YD

**E** White #945 \$16.95/YD



**FREE VIDEO: "How to Make a Sail Logo"**  
Watch at [Sailrite.com](http://Sailrite.com) (#X-HT-200163)



## PRE-CUT SAIL NUMBERS

0 1 2 3 4 5 6 7 8 9



Self-adhesive, black Dacron insignia material pre-cut numbers. Racing rules specify at minimum: 10" or 12" numbers for boats to 22' on the waterline, 15" for boats to 32', and 18" for larger boats. Select the appropriate size and number (#0-8).

Note: Order a #6 to use as a #9.

PART #	10"	12"	15"	18"
#100169	\$1.95 EA	\$2.95 EA	\$3.95 EA	\$4.95 EA

### COMPUTER EIGHTS

Quickly make any number (0-9) from one self-adhesive "Computer Style" Figure 8. Meets ISAF specifications. Black 12" polyester numbers.  
#100150 \$2.95 EA

# TRAMPOLINE MESH

Finish edges by folding over once or twice and sewing down. Reinforce with webbing or Shelter-Rite if desired.

## A BLACK TRAMPOLINE MESH

Black UV inhibited monofilament polypropylene basket weave mesh for small tramps. Tight weave provides firm, comfortable support.

Width: 74". Sold per linear yard.

#5624 \$19.95/YD

## B DACRON TRAMPOLINE MESH

Soft, white heavyweight Dacron knit mesh. Allows good drainage and less air blockage. Use for medium tramps, bags, lee cloths, and safety nets. Hole size: 5/16".

Width: 63". Sold per linear yard.

#361 \$21.95/YD

## C HEAVY-DUTY TRAMPOLINE MESH

White vinyl-coated woven 24 oz. polyester mesh with UV and mildew inhibitors. Allows good drainage and less air blockage. Holds up well in sunlight. Use for medium to large tramps on boats up to 40 feet. Hole size: 1/8" squares.

Width: 71". Sold per linear yard.

#100299 \$53.95/YD

## D SUPER TRAMPOLINE MESH

Very strong, durable 30 oz. white vinyl-coated woven polyester with good UV resistance and water shed. Use for very large catamaran tramps or livestock fencing. Hole size: 9/32" squares.

Width: 71". Sold per linear yard.

#100298 \$65.95/YD



# MESH & NETTING



## LIFELINE NETTING

Provide more security for family, friends, pets, and equipment around your sail or power boat! Knotted #36 nylon netting with UV stabilizers. Strong and durable with a tensile strength per cord of 350 lb. Use a hotknife to cut ends. Attach with plastic cable ties or whip into place with 1/8" Dacron braided line.

White #104801 \$1.95/FT

**MATERIAL:** Dupont #36 twisted nylon twine

**HEIGHT:** 24"-32" (As height is increased, diamonds will be stretched vertically)

**HOLE SIZE:** 2" x 2"

**TIP:** Order 1.35 times more length of netting than you need for a 24" height and 1.75 times more for a 32" height. When the lifeline expands to full width, the length shortens by 35-75%. See this product's page at Sailrite.com for more information.

## HOW TO INSTALL LIFELINE NETTING VIDEO

Watch at Sailrite.com #X-HT-200631



## MOSQUITO NETTING

Perfect for hot summer insect protection. Deceivably strong yet fine enough to stop "No-See-Ums". Nylon. Width: 60". Weight: 0.81 oz. per square yard. Sold per linear yard.

Black #106531 1-199 \$2.95/YD 200+ \$2.60/YD



## FIBERGLASS MESH

Tightly woven permanent glass yarn mesh with a medium-firm hand designed to keep out small insects! Coated with a protective vinyl to ensure lasting beauty, color, and flexibility with no rusting, corrosion, or staining. Allows for good ventilation, visibility, and some daytime privacy. Minimal shading. Recommended for enclosures and window screens (safe next to clear vinyl) 20 x 20 mesh. Width: 60". Sold per linear yard.

Charcoal #103122 \$8.95/YD

► [Need a Sample?](#) (details p.11)



## POLYESTER BAG MESH

Soft and durable polyester mesh with large (1/4") holes for extra breathability. Recommended for breathable gear bags, beach bags and laundry bags.

Width: 48". Sold per linear yard.

White #100147 \$6.95/YD



## POLYESTER MESH

Soft and durable 100% polyester mesh with easy water draining properties. Easy to handle. Recommended for bags, spinnaker socks and crafts. Weight: 4.1 oz. per square yard. Sold per linear yard.

42" Width #100682 \$4.95/YD

54" Width #100562 \$6.95/YD





### DURA SKRIM PATTERNING MATERIAL

## An Affordable, No-Stretch Material for Creating the Perfect Patterns

Create patterns right on your boat for your seats, enclosures, dodgers, flooring and more with Dura Skrim Patterning Material. This lightweight clear plastic sheeting can be pulled tight without stretching out of shape. Highly tear resistant, Dura Skrim is reinforced with a high-density polyethylene ribbon weave. Mark seam and cutting lines directly on clear plastic and transfer to canvas. Thickness: 6 mil. Width: 74". Tensile strength: 40 lbf. Sold per linear yard.

#103134

1-99 Yards **\$2.95/YD**

100+ Yards **\$1.92/YD**



### OTHER HELPFUL PATTERNING TOOLS



#### 3M FILAMENT STRAPPING TAPE

Support frames prior to installation. Use for bundling, reinforcing, and other light to medium work. Initial and long-lasting adhesion with good shear strength. Width: 3/4". 60 yard roll.

#5643 \$4.95 EA



#### SPRING CLAMPS

An extra hand when sewing, draping, and fitting fabric over a frame. Polished, rolled steel with soft vinyl tips. Safe on fabric and other materials. Length: 6". Jaw opening: 2".

#50211 \$4.95 EA



**FREE VIDEO: "How to Make Anti-Scorching Dividers for Boat Tubing"**  
Watch at [Sailrite.com](http://Sailrite.com) (#X-HT-200676)

## BOAT BLANKET

Extremely durable, protective fabric! This colorfast, solution-dyed, non-woven polyester fabric features a plush soft outer surface that acts like the loop side of a hook and loop closure. Sew on a strip of the hook side and fasten around anything needing protection. Resistant to sun, rot, chemicals, salt, stains, mildew, and mold. Cuts easily with scissors without fraying. Ships folded to reduce freight.

#### RECOMMENDED FOR:



Fender covers, anti-scorching dividers, pier piling covers, mooring and anchor line chafe guards, webbing sling pads and hiking strap covers

**SEWING:** See Thread & Needle Recommendations p.245

**MATERIAL:** Solution-dyed polyester

**WIDTH:** 72"

**WEIGHT:** 14.3 oz. per square yard

**SALE UNIT:** Sold per linear yard

**Please Note:** Boat Blanket is intended for use against gel coat and other hard-coated surfaces. Please use caution when using against painted or thin clear-coated surfaces.

► [Need a Sample?](#) (details p.11)



**BEIGE**  
#100112

\$19.95/YD



**GRAY**  
#100111

\$19.95/YD



**NAVY BLUE**  
#100109

\$19.95/YD

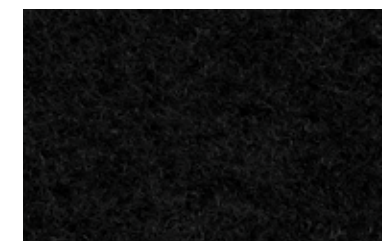

**BLACK**  
#100113

\$19.95/YD

#### FENDER COVER KITS (p.240)

Includes Boat Blanket material, thread, Velcro (hook side only) and instructions.

# WINDOW MATERIAL

Poly vinyl chloride (PVC) is the most common material used for flexible windows in fabric. Sailrite stocks 12 & 20 gauge roll goods (sold by the linear foot) and 30 or 40 gauge sheet goods. To install, first adhere window to fabric with basting tape (#129, p.139). Sew the window in position, and then trim away the fabric to expose the window.

- 5 MIL  
(Monofilm)
- 4 MIL  
(X-Ply Monofilm)
- 12 GAUGE  
(.012")
- 20 GAUGE  
(.020")
- 30 GAUGE  
(.030")
- 40 GAUGE  
(.040")

## WINDOW MATERIAL BUYING GUIDE

See p.89 for more information.

RECOMMENDED USE	PRODUCT	OPTICAL CLARITY	SCRATCH RESISTANCE	UV RESISTANCE	STAIN/CHEMICAL RESISTANCE	HAND	SIZES	PRICE / SQ. FT.
40 Gauge • Dodgers • Biminis • Windshields • Commercial enclosures • Fly bridge enclosures • Automotive windows • Convertible top windows	O'Sea 40 Gauge #120716	★★★★★	★★★★★	★★★★★	★★★★★	Soft, flexible	54" x 110" sheet	\$\$\$\$
	Strataglass 40 Gauge #123015	★★★★★	★★★★★	★★★★★	★★★★	Medium, semi-firm	54" x 110" sheet	\$\$\$\$\$
	Crystal Clear 40 Gauge #1187	★★★★★	★★★	★★★	★★	Medium, semi-firm	54" x 110" sheet	\$\$\$
	Regalite 40 Gauge #103741	★★★★★	★★★	★★★★	★★	Soft, flexible	54" x 110" sheet	\$\$\$
	Regalite 40 Gauge #103733	★★★★★	★★★	★★★★	★★	Soft, flexible	24" x 54" sheet	\$\$
	Kal-Glas 40 Gauge #5874	★★★★★	★★★	★★★	★★	Medium, semi-firm	29" x 68" sheet	\$\$
30 Gauge • Dodgers • Biminis • Enclosures • Automotive windows	O'Sea 30 Gauge #103734	★★★★★	★★★★★	★★★★★	★★★★★	Soft, flexible	54" x 110" sheet	\$\$\$\$
	Strataglass 30 Gauge #791	★★★★★	★★★★★	★★★★★	★★★★	Medium, flexible	54" x 110" sheet	\$\$\$\$\$
	Crystal Clear 30 Gauge #474	★★★★★	★★★	★★★	★★	Medium, flexible	54" x 110" sheet	\$\$
	Regalite 30 Gauge #103762	★★★★★	★★★	★★★★	★★	Soft, flexible	54" x 110" sheet	\$\$
	Regalite 30 Gauge #103730	★★★★★	★★★	★★★★	★★	Soft, flexible	29" x 68" sheet	\$\$
	Plastipane 30 Gauge #103439	★★★	★★★	★★	★★	Very soft/flexible	54" x 170" sheet	\$
20 Gauge • Sail windows • Enclosures • Biminis	Regalite 20 Gauge #103723	★★★★★	★★★	★★★★	★★	Soft, flexible	29" x 68" sheet	\$
	Plastipane 20 Gauge #28320	★★	★★	★★	★	Very soft/flexible	54" roll sold per ft.	\$
12 Gauge • Patterning • Vinyl couch cover	Plastipane 12 Gauge #102941	★★	★★	★★	★	Very soft/flexible	54" roll sold per ft.	\$

► Need a Sample? (details p.11)

**IMAR STRATAGLASS CLEANER**  
The safe way to clean and protect all clear vinyl window materials. See page 164 for more details



### Q. Why do vinyl windows turn cloudy and become brittle?

**A.** The key to keeping vinyl looking and performing like new is maintaining the integrity of the topcoat and protecting against UV damage. Vinyls contain plasticizers (chemicals that make them soft and pliable) that over time work their way to the surface and evaporate, wash away, or rub off. The top coat (PVF or PVDF) is applied to block plasticizers from migrating out of the material. Top coats greatly increase the life of vinyl windows, especially those left up permanently. Its effectiveness is reduced on applications that are taken on and off or folded regularly. Strataglass and O'Sea have a special polymer coating that is more scratch resistant and less susceptible to damage caused by folding.

### STRATAGLASS\*

Premium, long-lasting window material with polymer coating that seals in plasticizers to keep vinyl soft and flexible and increase scratch resistance. Polished for optimal consistency and clarity.

GAUGE	COLOR	SHEET SIZE	PART #	1-4	5+
30	Clear	54" x 110"	#791	\$188.95 EA	\$173.83 EA
40	Clear	54" x 110"	#123015	\$200.95 EA	\$184.87 EA
40	Lt Smoke	54" x 110"	#103594	\$216.95 EA	\$199.59 EA

### O'SEA\*

Premium scratch, chemical, and stain resistant press polished window material with excellent optical clarity and durability. Thermoplastic clear vinyl formulated and coated for maximum UV stability and highly polished for a soft, flexible vinyl. Easy to sew.

GAUGE	COLOR	SHEET SIZE	PART #	1-4	5+
30	Clear	54" x 110"	#103734	\$167.95 EA	\$154.51 EA
40	Clear	54" x 110"	#120716	\$178.95 EA	\$164.63 EA

### CRYSTAL CLEAR\*

Carefully polished to increase consistency and clarity.

GAUGE	COLOR	SHEET SIZE	PART #	1-4	5+
30	Clear	54" x 110"	#474	\$117.95 EA	\$106.16 EA
40	Clear	54" x 110"	#1187	\$126.95 EA	\$114.26 EA
40	Lt Smoke	54" x 110"	#103605	\$143.95 EA	\$129.56 EA

### REGALITE\*

Soft, flexible press polished window material with good optical clarity and durability. Standard marine grade thermoplastic clear vinyl with a highly polished finish. Easy to sew.

GAUGE	COLOR	SHEET SIZE	PART #	1-4	5+
20	Clear	29" x 68"	#103723	\$19.95 EA	\$17.96 EA
30	Clear	29" x 68"	#103730	\$25.95 EA	\$23.36 EA
30	Clear	54" x 110"	#103762	\$111.95 EA	\$100.76 EA
40	Clear	24" x 54"	#103733	\$25.95 EA	\$23.36 EA
40	Clear	54" x 110"	#103741	\$120.95 EA	\$108.86 EA

\*Edge flashing and factory trimming may reduce usable area by up to 3" per side.



▲ Smoke tint shown next to clear vinyl



### PATTERNING MATERIAL

Accurately pattern enclosures, dodgers, biminis and more with Dura Skrim Patterning Material. This durable material won't stretch so you can make exact patterns for the best fitting canvas. See p.86 for more information.

### KAL-GLAS

Carefully polished to increase consistency and clarity. Non-removable 2" AS-6 DOT certification stamp embossed 4 inches in from one corner.

GAUGE	COLOR	SHEET SIZE	PART #	1-4	5+
40	Mild Tint	29" x 68"	#5874	\$44.95 EA	\$40.46 EA

### PLASTIPANE

Most inexpensive and flexible clear vinyl, but the least optically clear. 12 and 20 gauge sold per linear foot off a roll and 30 gauge by the sheet. Easy to sew. Rolls compactly.

GAUGE	COLOR	WIDTH	PART #	PRICE
12	Clear	54"	#102941	\$2.50/FT

GAUGE	COLOR	WIDTH	PART #	1-179	180+
20	Clear	54"	#28320	\$2.20/FT	\$1.98/FT

GAUGE	COLOR	SHEET SIZE	PART #	1-4	5+
30	Clear	54" x 170"	#103439	\$71.95 EA	\$66.19 EA

### MONOFILM

Extremely stable, stiff, lightweight Mylar film used for telltale windows and windsurfer sails. Sold per linear yard.

THICKNESS	COLOR	WIDTH	PART #	PRICE
5 mil	Clear	52"	#2314	\$6.95/YD
4 mil Reinforced X-Ply	Clear	54"	#60022	\$13.95/YD

### WINDOW KIT

Install a window to make sailing with large, deck-sweeping sails much safer. Kit provides enough materials to install a large 12" x 54" viewing window in any sail. The key to successful installation is to use basting tape and wait to cut the sail until the window is sewn in place. Also great for dodger and awning window applications.

Kit Includes: 20 gauge Plastipane window material, white V-69 hembobs, basting tape, and instructions.

#33106A \$11.10 EA

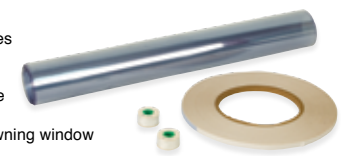

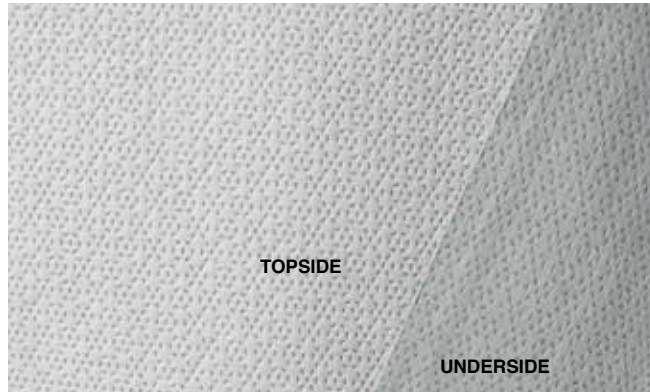

### NEW EVOLUTION® BLOCK-IT®

Like "sun block for your car!" this fabric is designed to protect vehicles from the harsh rays of the sun. This fabric blocks 99% of harmful UV rays and is quick drying, mold and mildew resistant and highly water resistant. Evolution won't shrink or stretch and it's unique four-layer construction prevents dings and dents.

#121040

1-14yds \$11.95/YD

15-299yds \$11.35/YD

300+yds \$10.76/YD

**RECOMMENDED FOR:**

Covers for automobiles, RVs, motorcycles, golf carts, bicycles and more

**SEWING:** See Thread & Needle Recommendations p.245

**MATERIAL:** Polypropylene/Polyethylene

**WIDTH:** 55"

**WEIGHT:** 4.8 oz. per square yard

**SALE UNIT:** Sold per linear yard



### THERMOZITE THERMAL-ACOUSTIC INSULATION

Excellent heat and sound barrier! Lightweight, durable, thermal-acoustic insulation composite made with Eco-fi™ polyester fiber (100% post consumer recycled plastic bottles). Laminated scrim reinforced foil on one side and jute carpet padding on the other. Install using 3M Super Trim Adhesive (#108090 p.163).

#103153 \$22.95/YD

**RECOMMENDED FOR:**

Insulation for headliners, hull liners, floors, doors, side panels, engine compartments, firewalls, machinery enclosures, and noisy pipes and valves

**WIDTH:** 48"

**WEIGHT:** 22 oz. per square yard

**THICKNESS:** 1/4"

**FIRE RATING:** FMVSS-302

**SALE UNIT:** Sold per linear yard

**NOISE REDUCTION COEFFICIENT:** 0.30

**THERMAL CONDUCTIVITY:** 0.280 K

**THERMAL RESISTANCE:** 1.3 R (increase 4x depending on distance from heat source)



### TONNEAU COVER

Extra wide vinyl/polyester material for seamless truck bed covers. Shrink-resistant, waterproof, washable, and long lasting. Highest tear and tensile strength available with low stretch and high abrasion resistance. Black.

#102942 \$15.95/YD

**RECOMMENDED FOR:**

Tonneau (truck bed) covers and protective covers

**WIDTH:** 77"

**WEIGHT:** 18 oz. per square yard

**SALE UNIT:** Sold per linear yard

**TENSILE STRENGTH:** Warp 183 lb. / Fill 145 lb.

**TEAR STRENGTH:** Warp 25 lb. / Fill 20 lb.

**HYDROSTATIC RESISTANCE:** 267 psi

► [Need a Sample?](#) (details p.11)



### TRUNKLINER

Durable, non-woven solution-dyed synthetic liner with excellent colorfastness and UV resistance. High resistance to stains (including gas, oil and salt), mold, and mildew. Cuts easily with scissors without fraying. Install using 3M General Trim Adhesive (#73211 p.163).

#103078 \$8.95/YD

**RECOMMENDED FOR:**

Automobile trunks, storage bins, and boat interior compartments

**WIDTH:** 54"

**WEIGHT:** 8.3 ounces per square yard

**SALE UNIT:** Sold per linear yard

**MATERIAL:** 100% Ecofi Polyester Nonwoven

## FOAM

# Find Just the Right Foam for Your Next Cushion Project

Selecting the right foam for your cushions can be a tricky process. There many considerations to weigh including the features of the foam and how you'll use the cushion. Choosing a foam often involves trade-offs and critical thinking about your priorities for the foam.

To help break down this process we've included descriptions of the features of each type of foam we carry as well as a comprehensive chart that side-by-side compares your options based on critical criteria including: recommended uses, available thicknesses, firmness, density, price and more.



### POLYESTER FIBERFILL

A non-allergenic, mildew resistant polyester stuffing, Polyester Fiberfill is made from blown polyester fibers and features a slick coating to prevent bunching. Typically used inside a pre-sewn cover made from Spun Bonded Pillow Protector Fabric (p.95) to stuff pillows, seat backs, or pet beds. Machine washable, but may need to be smoothed out after laundering.



### FAIRFIELD POLY-FIL NU-FOAM (Compressed Polyester)

A great foam alternative, Nu-Foam is actually a densified polyester batting. It will not yellow or disintegrate like traditional foam, but will compress over time. Nu-Foam is washable and will easily air dry after getting wet. It's also flame retardant, mildew resistant and non-allergenic. Use for occasional seating like patio cushions, chair pads, light upholstery and more.



### ANTI-MICROBIAL POLYURETHANE FOAM

The standard foam for outdoor cushions and boat seats, anti-microbial polyurethane foam is widely used by OEM boat builders. It will soak up water when it gets wet, but is treated with a biocide anti-microbial agent to prevent mildew growth. Anti-microbial polyurethane should be used where it is likely to stay dry or should be wrapped in a waterproofing layer, like Cushion Wrap Silk Film. Great for boat seats and cushions.

Continued on page 92

*New!*

## Sailrite Blade Foam Cutter with Carrying Case

Cut foam with ease and precision! Dual 8" blades (one moving) create clean cuts, even in high density foams. Rolling base plate steadies the saw for long, vertical cuts and can be removed for freehand cutting and angled edges. This saw also features adjustable speed settings and a locking trigger for long cuts. One year warranty. Comes in a padded carrying case.

110V #121244 \$199.95 EA

220-240V #121294 \$199.95 EA

Replacement Blade #121245 \$12.95 EA





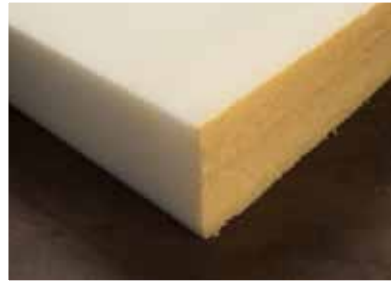

### DRY FAST OPEN CELL FOAM

Open cell foam features reticulated, open pores that allow air and water to easily flow through. As a result, Dry Fast foam does not retain water and makes a cool, comfortable cushion or mattress. Formulated with an antimicrobial agent so mold and mildew won't grow. When paired with an outdoor cushion fabric or Phifertex Mesh, open cell foam makes a virtually maintenance free cushion in sun, rain and snow.

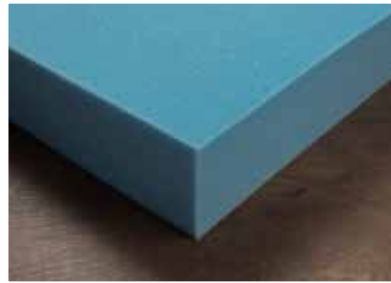

### HIGH DENSITY POLYURETHANE FOAM

The same base product as the Anti-Microbial Polyurethane Foam, but with a higher density and no anti-microbial treatment added. The higher density in this foam makes it more resilient and therefore better suited for high traffic areas. It's available in medium, firm and extra firm firmness levels and typically lasts up to 12 years. Use this foam for upholstery seating, high-use interior applications and for interior settee and berth cushions on dry boats.



### CLOSED CELL FOAM

Also known as flotation foam, Closed Cell Foam resists moisture adsorption, making it buoyant. It also resists weather aging and mechanical abrasion. Made from PVN this foam is 3 times firmer than polyurethane foam. Great for flotation applications like cockpit cushions and life vests. Install grommets along the sides or mesh on the bottom to reduce heat build-up which can shrink foam.



### POLYURETHANE FOAM WITH FABRIC BACKING

Also called scrim foam or sew foam, this thin sheet of polyurethane foam has a spun-bonded fabric adhered to one side. The backing holds stitches so you can sew through the foam to create pleats or channeling. It also holds adhesive well, making the foam easy to glue in place. Great for upholstery and headliner applications.

**Not sure which foam is best for you?** Read more about foam in our 7-part Foam Series, which even includes articles breaking down the pros and cons of foam choices for specific applications. Search "Foam Series" at [Sailrite.com](http://Sailrite.com) to see the whole series.

PRODUCT	RECOMMENDED USES	THICKNESS	SIZE (WxL)	FIRMNESS (IFD)	DENSITY (LB./CU. FT.)	WATER DRAINAGE	TREATMENT/ ADDITIVES	QUALITY	PART NUMBER	PRICE
<b>POLYESTER FIBERFILL (15 DENIER)</b> • Polyester stuffing • Slick coating to prevent bunching • Machine washable • White • Sold in 10 lb. bags	• Pillows • Seating backs • Pet beds • Filling	N/A	10 lb. bag	Soft	Variable	***	Slick, Anti-Bunch Finish	*****	#104467	\$56.95 EA
<b>FARFIELD POLY-FIL NU-FOAM (COMPRESSED POLYESTER)</b> • Compressed, densified polyester batting • Won't yellow or disintegrate • Washable • White	• Cushions • Futons • Chair pads • Light upholstery	2"	17" x 15"	Soft	Not Rated	***	None	**	#104007	\$9.95 EA
		2"	22" x 22"	Soft	Not Rated	***	None	**	#104006	\$15.95 EA
		3"	17" x 15"	Soft	Not Rated	***	None	**	#104005	\$13.95 EA
<b>ANTI-MICROBIAL POLYURETHANE FOAM</b> • Standard foam used by OEM boat builders • Treated with a biocide anti-microbial agent • Colors may vary	• Cushions • Marine seating	2"	19" x 48"	Medium (45)	1.4	*	Biocide	***	#104459	\$22.95 EA
		2"	19" x 59"	Medium (45)	1.4	*	Biocide	***	#104458	\$27.95 EA
		2"	20" x 21"	Medium (45)	1.4	*	Biocide	***	#104457	\$10.95 EA
		2"	26" x 30"	Medium (45)	1.4	*	Biocide	***	#104455	\$17.95 EA
		2"	26" x 51"	Medium/Soft (35)	1.4	*	Biocide	***	#104454	\$32.95 EA
		2"	26" x 51"	Medium (45)	1.4	*	Biocide	***	#104456	\$32.95 EA
	• Cushions • Marine seating • Mattresses (occasional use)	4"	19" x 48"	Medium/Soft (35)	1.8	*	Biocide	****	#104461	\$66.95 EA
		4"	20" x 21"	Medium/Soft (35)	1.8	*	Biocide	****	#104463	\$24.95 EA
		4"	26" x 30"	Medium/Soft (35)	1.8	*	Biocide	****	#104464	\$41.95 EA
	<b>REFLEX BIOCIDES FOAM</b> • Urethane foam formulated with an antibacterial agent • Widely used by OEM boat builders • Pale blue, green color	• Cushions • Marine seating • Mattresses (occasional use)	2"	48" x 81"	Medium (40)	1.5	*	Biocide	****	#104991
3"			48" x 81"	Medium (40)	1.5	*	Biocide	****	#104992	\$128.95 EA
4"			48" x 81"	Medium (40)	1.5	*	Biocide	****	#100160	\$196.95 EA
<b>DRY FAST OPEN CELL FOAM</b> • Open cell (reticulated) foam • Water & air pass through easily • Formulated with an anti-bacterial agent • Natural color	• Cushions • Marine seating • Mattresses (occasional use) • Berth cushions	2"	48" x 88"	Firm (60)	1.8	*****	Biocide	*****	#106402	\$151.95 EA
		3"	48" x 88"	Firm (60)	1.8	*****	Biocide	*****	#106403	\$227.95 EA
		4"	48" x 88"	Firm (60)	1.8	*****	Biocide	*****	#106404	\$303.95 EA
		5"	45" x 50"	Firm (60)	1.8	*****	Biocide	*****	#106405	\$189.95 EA
<b>CLOSED CELL FLOTATION FOAM</b> • 3x more firm than polyurethane foam • Bouyant • Passes federal motor vehicle safety standard 302 • Natural color • Sold per linear foot	• Cockpit cushions • Bosun's chairs • Life jackets	1/2"	56" Width	Extra Firm	3.0-5.0	N/A	N/A	*****	#101012	\$15.95/FT
		1-1/2"	56" Width	Extra Firm	3.0-4.5	N/A	N/A	*****	#101019	\$34.95/FT
<b>HIGH DENSITY POLYURETHANE FOAM</b> • High quality polyurethane foam • Typically lasts up to 12 years • Colors may vary	• Cushions • Marine Seating • Automotive Seating • Mattresses (frequent use) • Upholstery (frequent use)	1"	24" x 82"	Firm	2.8	*	None	*****	#120719	\$24.95 EA
		1"	24" x 82"	Extra Firm	2.8	*	None	*****	#121372	\$29.95 EA
		1"	36" x 82"	Firm	2.8	*	None	*****	#120720	\$37.95 EA
		1"	36" x 82"	Extra Firm	2.8	*	None	*****	#121371	\$43.95 EA
		2"	24" x 82"	Medium	2.8	*	None	*****	#120333	\$49.95 EA
		2"	24" x 82"	Firm	2.8	*	None	*****	#120194	\$49.95 EA
		2"	36" x 82"	Medium	2.8	*	None	*****	#120337	\$73.95 EA
		2"	36" x 82"	Firm	2.8	*	None	*****	#120197	\$73.95 EA
		3"	24" x 82"	Medium	2.8	*	None	*****	#120334	\$73.95 EA
		3"	24" x 82"	Firm	2.8	*	None	*****	#120195	\$73.95 EA
		3"	36" x 82"	Medium	2.8	*	None	*****	#120338	\$110.95 EA
		3"	36" x 82"	Firm	2.8	*	None	*****	#120198	\$110.95 EA
		4"	24" x 82"	Medium	2.8	*	None	*****	#120335	\$98.95 EA
		4"	24" x 82"	Firm	2.8	*	None	*****	#120196	\$98.95 EA
		4"	36" x 82"	Medium	2.8	*	None	*****	#120339	\$147.95 EA
		4"	36" x 82"	Firm	2.8	*	None	*****	#120199	\$147.95 EA
		5"	24" x 82"	Medium	2.8	*	None	*****	#120336	\$122.95 EA
		5"	24" x 82"	Firm	2.8	*	None	*****	#120276	\$123.95 EA
		5"	36" x 82"	Medium	2.8	*	None	*****	#120340	\$183.95 EA
		5"	36" x 82"	Firm	2.8	*	None	*****	#120277	\$184.95 EA
6"	24" x 82"	Medium	2.8	*	None	*****	#120717	\$147.95 EA		
6"	24" x 82"	Firm	2.8	*	None	*****	#120721	\$147.95 EA		
6"	36" x 82"	Medium	2.8	*	None	*****	#120718	\$220.95 EA		
6"	36" x 82"	Firm	2.8	*	None	*****	#120722	\$221.95 EA		
<b>POLYURETHANE FOAM WITH FABRIC BACKING</b> • Also known as scrim foam or sew foam • Spun-polyester backing • Easy to sew through and glue • Natural color • Sold per yard	• Upholstery • Headliner • Seat Backs • Channeling	1/4"	60" Width	Soft	Not Rated	*	N/A	N/A	#105432	\$7.95/YD
		1/2"	60" Width	Soft	Not Rated	*	N/A	N/A	#105431	\$14.95/YD
		3/4"	60" Width	Soft	Not Rated	*	N/A	N/A	#105045	\$23.95/YD



# Plump & Protect Your Foam

Wrap your foam in batting to soften the appearance of your cushion or wrap in silk film to add an extra moisture barrier.

## A CUSHION WRAP SILK FILM

Keep cushions dry with this noiseless plastic moisture barrier. Can also be used to shrink foam for easy insertion into a fabric cover. Center fold. Width: 54". Sold in 10 yard pieces.

#103933 \$15.95 / 10 YD

#105477 \$121.95 / FULL ROLL (720 YARDS)

## B POLYESTER BATTING

100% polyester cushion wrap designed to protect foam from UV rays and fill out cushion edges. Non-allergenic, mildew resistant, and drains well. Secure in place with a spray adhesive like 3M Super 77 (#636100, p.163). White. Width: 55". Weight: 0.75 oz. per square yard. Thickness: 3/4". Sold per linear yard.

#100158 \$5.95/YD



### SHRINK YOUR FOAM WITH SILK FILM!

Are you having trouble fitting your foam into a cushion cover? You can use silk film to shrink your foam up to 70% of its original size! Learn how at [Sailrite.com](https://www.sailrite.com) #X-HT-300060

# PILLOW FORMS



## DIY AT SAILRITE.COM

- How to make a neckroll pillow with piping #X-HT-200632
- How to make pillow forms #X-HT-200594

# Keep Cushions from Slipping!

## CUSHION UNDERLINING

Lightweight polyester fabric designed for use on the bottom side of cushions, seats, and upholstery. Light vinyl coating allows water drainage and air circulation. Resists rot and mildew. Width: 54". 9 oz. per square yard. Sold per linear yard.

Gray #774100 \$6.95/YD

White #768100 \$6.95/YD

Beige #103934 \$6.95/YD

Black #772100 \$6.95/YD



## SNAP TOGETHER BUTTON FORMS

Dress up pillows, cushions and upholstery with fabric-covered buttons. Cover top with fabric and press together. Teeth hold fabric securely in place. Wash or dry clean. Nickel-plated brass.

DIAMETER	PART #	1-19	20+
9/16"	#100187	\$1.95/PK5	\$1.76/PK5
3/4"	#100188	\$1.95/PK5	\$1.76/PK5
7/8"	#100189	\$2.95/PK5	\$2.66/PK5
1-1/8"	#100194	\$3.95/PK5	\$3.56/PK5

## SUPREME POLY-FIL SOFT TOUCH® PILLOW FORMS

Classic comfort Soft Touch luxury pillow inserts have the look and feel of down and are a popular choice for home and cabin decor. Cover with your favorite decorative fabric to create a perfect accent piece for any space. On board your boat, Sunbrella is a great durable and colorfast choice for pillows. Pillow forms are machine washable. Air dry or dry in low heat setting. Add dryer balls to keep pillows fluffy.

**FILL:** 100% Soft Touch® polyester fiberfill

**COVER:** 65% poly / 35% cotton (200 thread count)

### SQUARE PILLOW FORM

14" x 14" #120595 \$8.95 EA

16" x 16" #120596 \$10.95 EA

18" x 18" #120597 \$14.95 EA

20" x 20" #120598 \$17.95 EA

24" x 24" #120599 \$23.95 EA

30" x 30" #120601 \$36.95 EA

### NECKROLL PILLOW FORMS

5" x 14" #120591 \$11.95 EA

6" x 20" #120592 \$13.95 EA

9" x 14" #120593 \$19.95 EA

9" x 20" #120594 \$22.95 EA



## SPUN BONDED PILLOW PROTECTOR FABRIC

Create your own pillow forms with this non-woven polypropylene fabric. Breathable, non-allergenic, water repellent, and resistant to moisture and stains. Resists tearing. 1.25 oz. Width: 60".

**A #104466 \$2.95/YD**

**B POLYESTER FIBERFILL - 15 DENIER p.92**

Industrial Quality.  
Unrivalled Performance.

# ULTRA FEED<sup>®</sup> SEWING MACHINES

The Sailrite Ultrafeed is a portable,  
powerful machine with superior  
performance and great versatility.

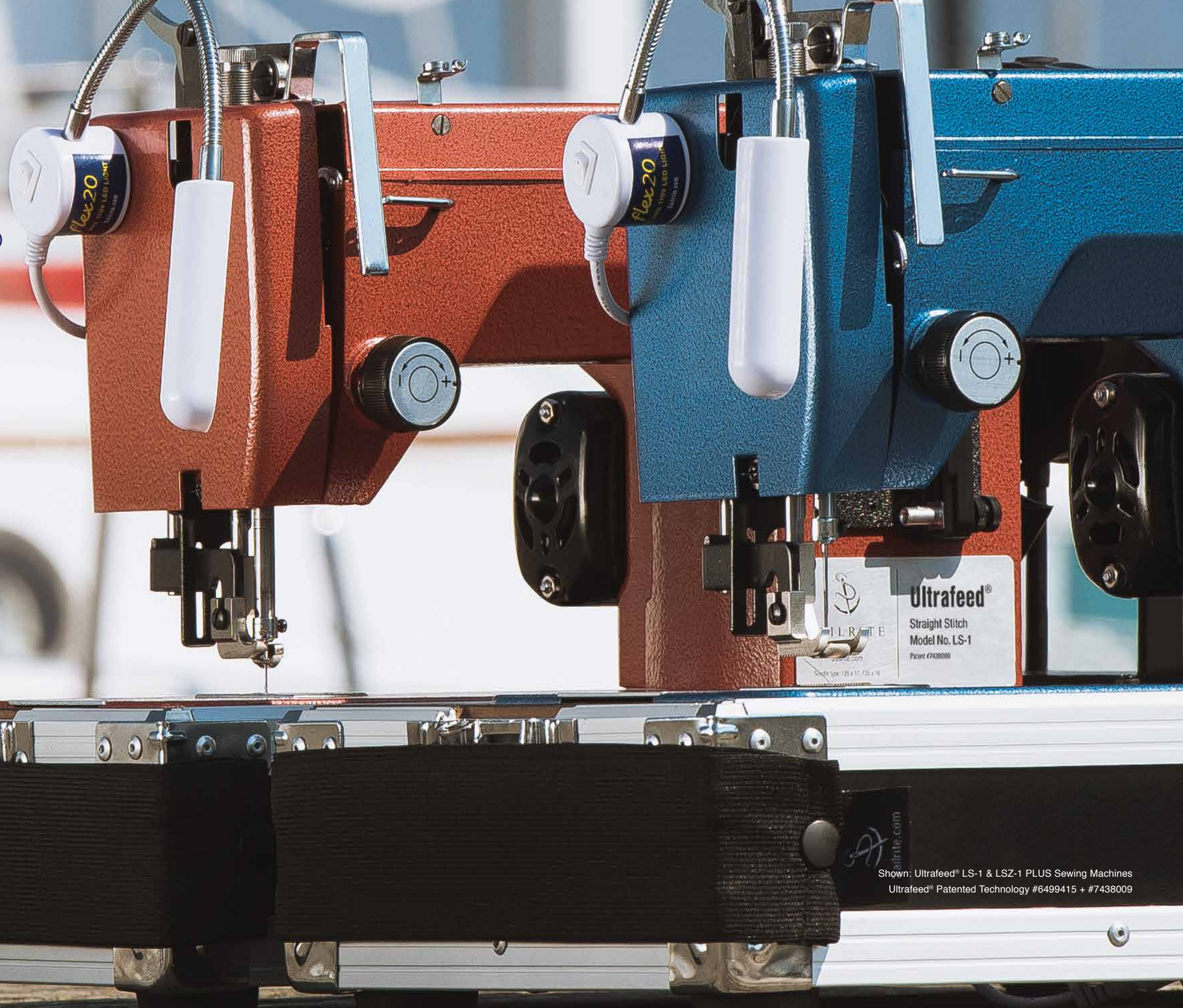

Shown: Ultrafeed<sup>®</sup> LS-1 & LSZ-1 PLUS Sewing Machines  
Ultrafeed<sup>®</sup> Patented Technology #6499415 + #7438009

# TRIED & TRUE.

Built with only the toughest and most reliable of parts, the Ultrafeed is designed to make working with layers of heavy canvas, thick materials and sailcloth easy. Use the Ultrafeed anywhere (i.e. on the dock, at home and outside) to do everything from repairing sails or making outdoor cushions to fixing a tent or to shorten jeans. Combine the Ultrafeed sewing machine with our outstanding support and take on your next project with confidence.

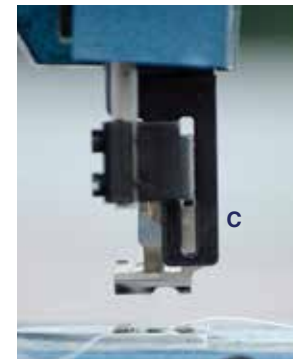
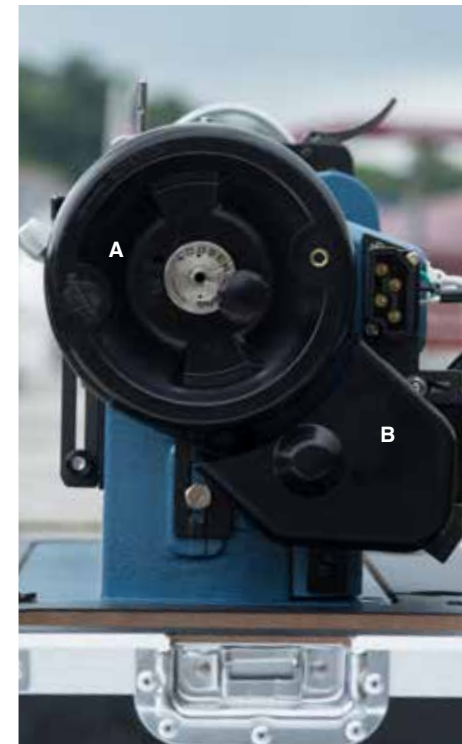

## Sew with Confidence.

Sailrite provides unbeatable support and instructional resources with streaming videos, in-depth guidebooks and personalized tech support. Even beginning sewers find the Ultrafeed to be a very straight forward, user-friendly machine!

### DOUBLE THE POWER.

**A.** The Power Plus Wheel has twice the power (and size!) of a typical portable sewing machine for more slow speed power and control and the ability for slow, precise stitching.

### POWER UP.

**B.** Powered with a 110 VAC or 220-240 VAC motor and cogged belt and pulley drive system to develop 6,600 rpm at 1.5 amps (220-240 VAC motors have European plug).

### HANDY FEATURES.

**C.** A special welting tunnel is built into the presser foot to simplify piping installation and a needle-positioning lever, with left, right, and center movement (LSZ-1 only), allows for zipper installation without needing to change the presser foot.

### SIMPLE SEWING.

**D.** The mechanical walking presser foot ensures layers of fabric (even heavy, bulky, and sticky materials!) consistently move together through the machine for easy sewing and symmetrical stitch lengths.

### GO PORTABLE.

**E.** This heavy-duty Industrial Carrying Case protects the machine so you can sew and stow anywhere! Foam pads inside the lid allow the machine to be stored on its side. Included with PLUS and PREMIUM packages.

### NO SLIPPING.

**F.** Sailrite's patented Posi-Pin clutching system transfers 100% power from the balance wheel to the needle to keep your needle from stalling on heavy materials.

### INDUSTRIAL STRENGTH POWER.

**G.** With 3/8" high foot lift and best-in-class needle bar stroke, you can sew virtually anything you can squeeze underneath! Sew through as many as 10 layers of heavy canvas in straight stitch or as many as 8 layers of 8 oz. Dacron in zigzag stitch.

### SAFETY FIRST.

The electronic foot control is fully grounded and features a long cord for convenient, safe sewing. Our patented "scarfed" hook also minimizes the potential for the needle to strike the hook.

### QUICK STITCH SETTING.

Set your stitch length range with just the turn of two thumb screws with the EZ Set Stitch Length Plate. These settings help to keep your stitch length consistent when switching from forward to reverse, so you can just push and release the spring loaded stitch length lever.



# ULTRAFEED® LSZ-1

Zigzag & Straight Stitch  
Sewing Machine

Ultrafeed® Patented Technology #6499415 + #7438009

## SPECIFICATIONS

**POWER:** 1/10th hp; 110V (U.S.) / 220-240V (EU.); AC motor; 1.5 amp (U.S.) / 0.7 amp (EU.); 50/60 Hz

**MOTOR RPM:** 110V: 6600 RPM at 1.5 amps  
220-240V: 8200 RPM at 0.7amps

**MAX SEWING SPEED** (stitches/minute): 500 spm

**SHUTTLE:** Oscillating (Cam/Rocker Arm Driven)

**STRAIGHT STITCH LENGTH:** Max. 6 mm

**MIN/MAX ZIGZAG STITCH WIDTH:** 0-5 mm

**NEEDLE BAR STROKE:** 34 mm

**NEEDLE SYSTEM:** 135 X 17, 135 X 16

**BED SIZE:** 14.5" X 7"

**UNDERARM SPACE:** 7" X 4.5"

**PRESSER FOOT LIFT:** 3/8"

**BOBBIN SIZE:** Class 15 /  
Style A (20.5 mm Dia. x 10.8 mm H)

**NEEDLE SIZE RANGE:** #10-#22

**THREAD RANGE:** Home sizes to V-92

**LUBRICATION:** Manual

**CARRYING WEIGHT:** 49-62 lb.



# ULTRAFEED® LSZ-1

Zigzag & Straight Stitch  
Sewing Machine Packages



## BASIC

#300601 (110V)

\$799<sup>00</sup>



## PLUS

#300602 (110V)  
#220600 (220-240V)

\$949<sup>00</sup>



## PREMIUM

#300603 (110V)  
#220603 (220-240V)

\$1,249<sup>00</sup>

### PACKAGE INCLUDES:

INDUSTRIAL CARRYING CASE		✓	✓
ULTRAFEED WOODEN BASE	✓		
POWER PLUS BALANCE WHEEL	✓	✓	✓
EZ SET STITCH LENGTH PLATE (Installed)	✓	✓	✓
ELECTRONIC VARIABLE SPEED FOOT CONTROL	✓	✓	✓
THREAD STAND	✓	✓	✓
SEWING MACHINE OIL	✓	✓	✓
BOBBINS (4)	✓	✓	✓
NEEDLES (4)	✓	✓	✓
TOOL KIT	✓	✓	✓
FLEX20 LED LIGHT		✓	✓
ELASTIC PROTECTOR STRAP		✓	✓
V-92 WHITE POLYESTER THREAD 1 OZ.		✓	✓
INTEGRATED THREAD STAND		✓	✓
MONSTER II BALANCE WHEEL			✓
1" SWING-AWAY BINDER			✓
DELUXE MAGNETIC SEWING GUIDE			✓
KICKSTAND			✓
LEFT ROPING ZIPPER FOOT			✓
CORDING FOOT SET FOR LARGE WELTING			✓
NEEDLE ASSORTMENT PACK WITH DELUXE SEAM RIPPER & LINT BRUSH			✓
COMPREHENSIVE GUIDEBOOK	✓	✓	✓
2 YEAR WARRANTY	✓	✓	✓

### OUR SUPPORT GUARANTEE

At Sailrite, we are committed to helping you get the most out of your Ultrafeed Sewing Machine. That's why we are proud to offer you personalized support for the lifetime of your machine. We'll be here to help you service your machine with in-depth videos, one-on-one support, and Sailrite's 2-year limited warranty. Should you need them, we have replacement parts in stock and ready to ship out to you and, if necessary, you can always send your machine back to us for repairs.

For complete warranty information visit [Sailrite.com/Warranties](http://Sailrite.com/Warranties)

### WHERE ARE ULTRAFEED SEWING MACHINES MADE?

Ultrafeed Sewing Machines are assembled in the United States using high quality parts from around the world.



# ULTRAFEED® LS-1

Straight Stitch  
Sewing Machine

Ultrafeed® Patented Technology #7438009

## SPECIFICATIONS

**POWER:** 1/10th hp; 110V (U.S.) / 220-240V (EU.); AC motor; 1.5 amp (U.S.) / 0.7 amp (EU.); 50/60 Hz

**MOTOR RPM:** 110V: 6600 RPM at 1.5 amps  
220-240V: 8200 RPM at 0.7amps

**MAX SEWING SPEED** (stitches/minute): 500 spm

**SHUTTLE:** Oscillating (Cam/Rocker Arm Driven)

**STRAIGHT STITCH LENGTH:** Max. 6 mm

**NEEDLE BAR STROKE:** 34 mm

**NEEDLE SYSTEM:** 135 X 17, 135 X 16

**BED SIZE:** 14.5" X 7"

**UNDERARM SPACE:** 7" X 4.5"

**PRESSER FOOT LIFT:** 3/8"

**BOBBIN SIZE:** Class 15 / Style A  
(20.5 mm Dia. x 10.8 mm H)

**NEEDLE SIZE RANGE:** #10-#22

**THREAD RANGE:** Home sizes to V-92

**LUBRICATION:** Manual

**CARRYING WEIGHT:** 47-61 lb.

## ULTRAFEED® LS-1

Straight Stitch Sewing  
Machine Packages



### BASIC

#300501 (110V)

\$699<sup>00</sup>



### PLUS

#300502 (110V)  
#220500 (220-240V)

\$849<sup>00</sup>



### PREMIUM

#300503 (110V)  
#220503 (220-240V)

\$1,149<sup>00</sup>

#### PACKAGE INCLUDES:

INDUSTRIAL CARRYING CASE		✓	✓
ULTRAFEED WOODEN BASE	✓		
POWER PLUS BALANCE WHEEL	✓	✓	✓
EZ SET STITCH LENGTH PLATE (Installed)	✓	✓	✓
ELECTRONIC VARIABLE SPEED FOOT CONTROL	✓	✓	✓
THREAD STAND	✓	✓	✓
SEWING MACHINE OIL	✓	✓	✓
BOBBINS (4)	✓	✓	✓
NEEDLES (4)	✓	✓	✓
TOOL KIT	✓	✓	✓
FLEX20 LED LIGHT		✓	✓
ELASTIC PROTECTOR STRAP		✓	✓
V-92 WHITE POLYESTER THREAD 1 OZ.		✓	✓
INTEGRATED THREAD STAND		✓	✓
MONSTER II BALANCE WHEEL			✓
1" SWING-AWAY BINDER			✓
DELUXE MAGNETIC SEWING GUIDE			✓
KICKSTAND			✓
LEFT ROPING ZIPPER FOOT			✓
DOUBLE CORDING FOOT SET			✓
NEEDLE ASSORTMENT PACK WITH DELUXE SEAM RIPPER & LINT BRUSH			✓
COMPREHENSIVE GUIDEBOOK	✓	✓	✓
2 YEAR WARRANTY*	✓	✓	✓

#### OUR SUPPORT GUARANTEE

At Sailrite, we are committed to helping you get the most out of your Ultrafeed Sewing Machine. That's why we are proud to offer you personalized support for the lifetime of your machine. We'll be here to help you service your machine with in-depth videos, one-on-one support, and Sailrite's 2-year limited warranty. Should you need them, we have replacement parts in stock and ready to ship out to you and, if necessary, you can always send your machine back to us for repairs.

For complete warranty information visit [Sailrite.com/Warranties](http://Sailrite.com/Warranties)

#### WHERE ARE ULTRAFEED SEWING MACHINES MADE?

Ultrafeed Sewing Machines are assembled in the United States using high quality parts from around the world.



### DELUXE MAGNETIC SEWING GUIDE

High strength magnetic sewing guide with extended length! Stays firmly in place even when sewing heavy materials. Extended length ensures accurate stitch placement in hems and general seam construction. Use to replicate a double needle sewing machine stitch on a single needle machine with a needle offset lever. Turn sideways for applications where a short guide is required. Easy to remove. Non reflective matte finish. Made in the USA. Length: 5-1/2". Included with Ultrafeed PREMIUM packages.

**A #103597 \$31.95 EA**



### KICKSTAND

Keep the Ultrafeed from toppling over when hinged back in its portable case. Use on any Ultrafeed sewing machine in the Industrial Case. Fits into a slot in the case. Included with Ultrafeed PREMIUM packages. Made in the USA.

**G #107143 \$13.95 EA**



### EZ SET STITCH LENGTH PLATE

Sew with precise and consistent stitch lengths in both forward & reverse! This plate installs directly onto your Ultrafeed Sewing Machine and allows you to sew in at least 6 mm stitches in forward and reverse. Spring loaded stitch length lever makes changing from forward to reverse quicker. This patented technology comes standard on all Ultrafeed Sewing Machine models & packages. Easily added to older Ultrafeed machines. Made in the USA.

**B #105511 \$49.95 EA**



### NEEDLE PLATE

Easily maintain your seam allowances with markers right on your needle plate! Measurements are laser engraved at 1/4" (LS-1 only), 1/2", 3/4" and 1". Replace damaged plates or upgrade to this engraved version. Now comes standard on all Ultrafeed Sewing Machine models and can easily be added to older Ultrafeed machines.

**C LSZ-1 #W032Z \$14.95 EA**  
**LS-1 #W032 \$14.95 EA**



### SAILRITE FLEX20 LED LIGHT

A small, bendable LED light that provides bright concentrated light. Adjust your lighting with a 7-inch flexible neck that stays where you put it. Stick to any metal surface with the magnetic base or use the included adhesive disc. The perfect sewing machine or tool bench light. 20 energy saving LED bulbs. Does not get hot. 55-inch cord. Included with Ultrafeed PLUS and PREMIUM packages.

**D 110V LED #104303 \$39.95 EA**  
**220-240V LED (2 pin plug) #104304 \$39.95 EA**



### MONSTER II BALANCE WHEEL

Made exclusively for Sailrite, the Monster II Balance Wheel is a top-tier flywheel that brings smoother and quieter operation to your Ultrafeed. It is twice the size of a traditional portable sewing machine flywheel and provides better slow speed control and exceptional power. A hand crank allows for sewing without electricity. Made from 7 pounds of nickel-plated steel, this balance wheel's weight creates enough momentum to make hand-cranking effortless while smoothly sewing through even thick assemblies. Included with Ultrafeed PREMIUM packages.

**E #604U \$125.00 EA**



### INTEGRATED THREAD STAND

Conveniently ready to use and quick to store! Fasten to the Industrial Carrying Case, Ultrafeed Wooden Base, or any sewing table and pivot to ideal thread feeding position. Thread feeds smoothly with no tangling or wobbling. Easy to install. Fits up to 16 oz. cone. Tough thermoplastics with stainless steel hardware. Included with Ultrafeed PLUS and PREMIUM packages. Made in the USA.

**F #103658 \$25.95 EA**



**NEEDLE ASSORTMENT PACK**

Includes: 40–135 x 17 Needles (10 each: #14, 16, 18 & 20), deluxe seam ripper, and maintenance brush. Included with Ultrafeed PREMIUM packages.

#5343 \$23.70 EA



**THREAD ASSORTMENT KIT**

Includes: 10–Metal bobbins (Class 15), 12–Style A\* V-69 bobbins, 12–Style A\* V-92 bobbins, 1–1 oz. cone of V-30, V-46, and V-69 thread (3 total), 1–4 oz. cone of V-92 thread.

#9960 \$49.95 EA

\*Style A fits Reed, Yachtsman, Mini-Walker, Ultrafeed, and most home sewing machines.



**CRUISER'S SPARES FOR ULTRAFEEDS**

Convenient Ultrafeed spare parts and supplies package. Includes: Bobbin case, retaining ring cap spring, shuttle hook, 8" timing belt, 18.6" timing belt, needle set screw, take-up spring, retaining ring clips, replacement Posi-Pin, sewing machine oil, presser foot screws (2), and feed dog screws (2). All items also sold separately.

#85962A \$83.45 PK

# Ultrafeed® Collapsible Sewing Table



**CORDING FOOT SET FOR LARGE WELTING**

Sew extra large and soft welting (up to 1/4") with this foot. Ultrafeed LSZ-1 only. Included with the Ultrafeed® LSZ-1 PREMIUM Packages.

#104854 \$33.00 EA



**LEFT ROPING ZIPPER FOOT**

Get a close stitch when sewing zippers with this zipper foot. Included with the Ultrafeed® PREMIUM Package.

LS-1 #905 \$29.95 EA

LSZ-1 #896 \$29.95 EA

See our complete selection of presser feet on p.119

## Even More Add-Ons to Love

Complete your Ultrafeed® with these great add-ons and helpful replacement parts.



**1" SWING BINDER ATTACHMENT**

Make sewing binding a breeze! Guides and folds 1" tape over fabric edges. When you're done, swing it out of the way! Made in Japan. Included with the Ultrafeed® LSZ-1 PREMIUM Packages.

#100103 \$69.00 EA

See our complete selection of binders on p.123



**ULTRAFEED INDUSTRIAL CARRYING CASE**

Durable, reinforced case designed especially for the Ultrafeed Sewing Machine. The case is constructed from a plywood frame laminated in black melamine framed with aluminum edges. Corners are reinforced with a zinc alloy. Foam pads inside the lid keep your Ultrafeed supported. Sailrite logo on the lid denotes which direction the lid should face. Foot control, Monster II Balance Wheel with hand crank and the Integrated Thread Stand all fit nicely inside the case. Included with Ultrafeed PLUS and PREMIUM packages.

Size: 21.75"W x 14.625"H x 10.625"D | Cut-out: 7.125" x 14.75"

#120162 \$199.95 EA



**ULTRAFEED WOODEN BASE**

High-quality, solid base for the Ultrafeed Sewing Machine. Made exclusively for Sailrite in the USA from a solid piece of machine routed MDF. Lacquer coating gives the base a smooth, durable finish. Features rounded trays for storing bobbins and needles. Cutouts provide hand holds for transporting. Eliminates the need for a kickstand. Included with Ultrafeed BASIC packages. Base does not fit in the Ultrafeed Collapsible Sewing Table.

Size: 17.375"W x 2.875"H x 15"D | Cut-out: 7.28" x 14.8"

#104831 \$99.95 EA

Collapsible, portable sewing table with an adjustable drop down shelf designed with the Ultrafeed Sewing Machine in mind. This modified Gidget II table has a special cut out that perfectly fits the Ultrafeed in the Industrial Carrying Case.

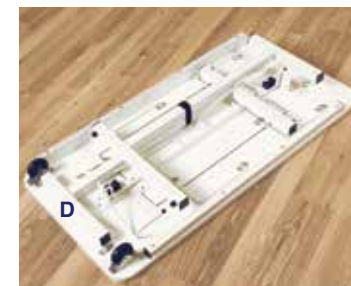

**A** Lower cut out for machine and adjust height for an even sewing table surface.

**B** Raise cut out to use as a flat table.

**C** Mar-resistant melamine tabletop with handy measuring tape across the front.

**D** Easy storage! Steel legs lock in place for use and fold flat and secure with hook & loop when not in use. Fits under a bed or bunk (4-1/8" folded height).

**E** Two wheels for easy transport.

**Table:** Top: 40" x 19.75" **Height:** 28.25"  
**Cutout:** 22" x 11" **Weight:** 30 lbs.

Ships fully assembled! #104821 \$195.00 EA

PLEASE NOTE: The Ultrafeed Wooden Base #104831 that comes standard with the Basic Ultrafeed Machines will not fit in this table



New!

# SAILRITE® ULTRA FEED® INDUSTRIAL SEWING TABLES

Create a stationary workstation for your Ultrafeed Sewing Machine with these industrial table stands. The spacious tabletop features a cutout that fits the Ultrafeed without its case and is made from thick plywood with a melamine laminate surface. Sturdy k-legs can raise and lower from 28 to 34 inches. Includes oil tray and threaded insert for the optional Integrated Thread Stand.

Choose between a table-only package or the table with the Workhorse Servo Motor, which equips your Ultrafeed with even better slow speed power and quiet sewing. The Workhorse allows for fully adjustable speed settings. Set the maximum sewing range between 123-616 stitches per minute while never losing the ability to sew stitch by stitch. Making use of the Servo motor requires you to remove the standard Ultrafeed motor and creates a non-portable set-up. A new timing belt and belt cover come included in the Servo motor package. The Servo motor must be used with the Power Plus Balance Wheel.



## SPECIFICATIONS

Tabletop Width	47.5"
Tabletop Depth	20"
K-leg Width	38"
K-leg Depth	16.625"
Machine Cutout	14.75" x 7.125"
Adjustable Table Height	28"- 34"

### A SAILRITE® ULTRA FEED® INDUSTRIAL SEWING TABLE

#120934 \$299.00 EA

### B SAILRITE® ULTRA FEED® INDUSTRIAL SEWING TABLE & WORKHORSE SERVO MOTOR

(110V) #120931 \$499.00 EA

(220-240V) #121091 \$499.00 EA

▶ See the stitch-by-stitch power of the Ultrafeed paired with the Workhorse Servo Motor at [Sailrite.com](http://Sailrite.com)



## THE WORKHORSE SERVO MOTOR

A quiet, energy saving motor that doesn't scrimp on power.

A Sailrite exclusive! The Workhorse is a 550 watt, 3/4 horsepower servo motor designed for continuous use on industrial sewing machines. 12-coil design means the motor rotation is smooth, creating a fluid motor to machine power transfer. Brushless motor provides high torque even from a complete stop. Fully adjustable speed settings let you control the top stitching speed while maintaining variable speed control. Speed settings range from 400-3600 stitches per minute (even slower with our Stitch PRO Balance Wheel included on all Sailrite Industrial Sewing Machines or the Power Plus Balance Wheel on the Ultrafeed Sewing Machines). 2-Year warranty.

The Workhorse comes standard on all Sailrite Fabricator and Professional Sewing Machines. Can also be used on other commercial machines with the Power Twist V-Belt (#100815 p.118).

Includes: 60mm pulley, treadle linkage bars, mounting hardware, belt guard, extra fuses and installation instructions.

110V #120260 \$196.00 EA • 220-240V (EU) #120261 \$196.00 EA

# SAILRITE FABRICATOR®

## Straight Stitch Sewing Machine

The Sailrite Fabricator is a sewing machine to build your small business on! This full-sized industrial, straight stitch sewing machine with a compound walking foot was designed for serious DIY-ers and small canvas, awning and upholstery shops. The Fabricator lets you truly sew stitch-by-stitch at full power so you can take your time focusing on the details.

The Fabricator is powered by our Workhorse Servo Motor, which allows you to set the top sewing speed while keeping variable speed control. This best-in-class machine features high quality castings and machined parts. Each machine is fine-tuned and adjusted by Sailrite's expert sewing machine technicians ensuring it will be a dependable machine for years to come!

### STANDARD FEATURES:

- Workhorse Servo Motor
- Compound Walking Foot
- 9/16" Foot Height with Knee Lift
- 8 mm Stitch Length
- Large 10.25" x 5" Underarm Space
- Large Bobbin Size
- Patented Posi-Pin Clutching System
- Stitch PRO Balance Wheel

### RECOMMENDED FOR:

- Upholstery
- Soft-Medium Weight Leather
- Marine Canvas
- Curtains & Draperies



# Sailrite Fabricator®

## Straight Stitch Sewing Machine

The Sailrite Fabricator comes standard with all the great features seen here and more. See a full components list on p.113.



### LARGE ROTARY HOOK

Large Rotary hook and bobbin reduce frequency of bobbin winding. Sew with up to size V-138 thread.



### WALKING FOOT

Compound walking foot assures absolute control of the fabric—the needle penetrates the fabric and then moves back with the material. Great for sewing soft to medium weight leather, canvas, upholstery and vinyl.

### F. DELUXE INDUSTRIAL THREAD STAND

The sturdy, Deluxe Industrial Thread Stand can hold two cones of thread. Thread gets pulled off the top of the cone for proper thread twist and tension. Accommodates up to 16 oz. thread cones.



### E. STITCH PRO BALANCE WHEEL & BOBBIN WINDER

Custom-designed for use with the Workhorse Servo Motor and the Posi-Pin Clutching System, this balance wheel is made from black, hard coat anodized aluminum. It's weight and size are perfectly balanced for strong, smooth power. Each machine also features a separate bobbin winder so you can wind bobbins quickly and easily without unthreading the machine.

### D. OIL PAN

Auto lubrication with oil pump and pan ensures long life and smooth operation.

### C. WORKHORSE SERVO MOTOR

A Sailrite exclusive, the 3/4 horsepower Workhorse Servo motor is a quiet and energy-efficient motor with smooth and fluid motor to machine power transfer. Includes fully adjustable speed settings and high torque—even from a complete stop!

### G. TABLE

High quality k-leg table and power stand that includes a knee lift, machine support pin and drawer.

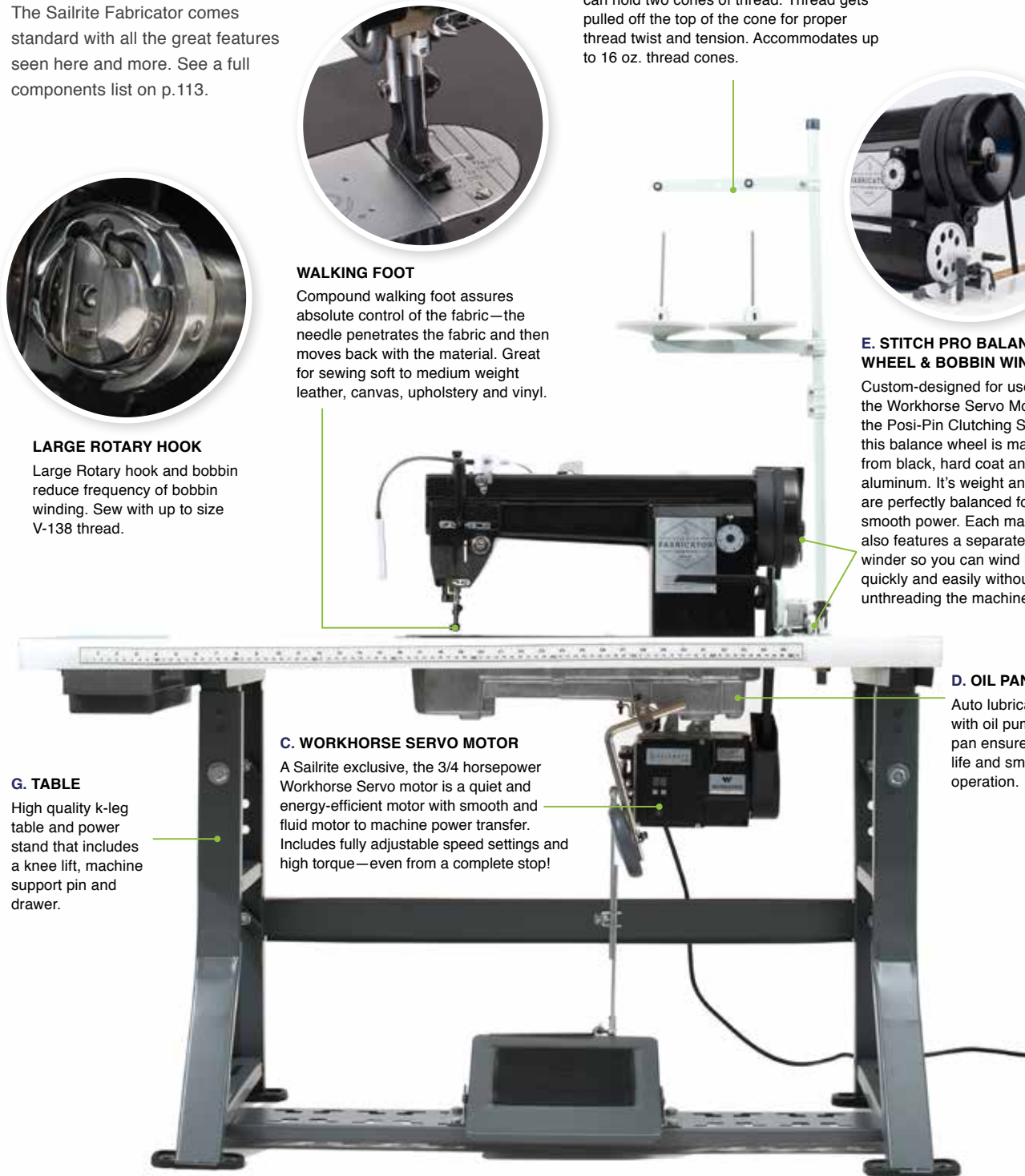

## WITH THE FABRICATOR, YOU GET THE POWER & VERSATILITY TO SEW...



Sailmaker's Leather  
(5 layers of soft leather)



Assemblies with Variable Thicknesses  
(8 layers of marine vinyl + 4 layers of webbing)



Heavy Canvas Applications  
(10 layers of canvas + 4 layers of clear vinyl)

Plus, all your décor below deck including cushions, curtains and more!



### THE SAILRITE FABRICATOR PACKAGES INCLUDE:

- A. 44 Assorted 135 x 17 Needles (#14, #16, #18, #20, and #23)  
4oz V-92 Thread  
5 Large Capacity Bobbins  
Oil  
3 Screw Drivers  
Seam Ripper  
Maintenance Brush  
Sailrite Fabricator Guidebook
- B. Flex20 LED Light (110V or 220-240V)
- C. Sailrite Workhorse Servo Motor (110V or 220-240V)
- D. Oil Pan/Reservoir
- E. Sailrite Stitch PRO Balance Wheel with patented Posi-Pin Clutch System  
Belt Cover/Belt  
Bobbin Winder
- F. Industrial Thread Stand
- G. Industrial Tabletop and Legs  
Support Pin  
Knee Lift  
Table Drawer

### WHERE IS THE SAILRITE FABRICATOR MADE?

The Sailrite Fabricator is assembled in the United States using high quality parts from around the world.

### SPECIFICATIONS

Application	Light, Medium & Heavy-Duty
Shuttle	Full Rotary, Gear Driven
Max. Straight Stitch	0-8mm
Sewing Speed	Stitch-by-Stitch to 1,108spm
Needle System	135 x 17 & 135 x 16
Bed Size	18.75" x 7"
Underarm Space	10.25" x 5"
Presser Foot Lift	Hand 6.5mm (1/4") Knee Lift 14mm (9/16")
Bobbin Size	Large Style M Bobbin
Needle Size	Sizes #10-#24
Thread Range	V-30 to V-138
Lubrication	Auto Lubrication
Built-In Knee Lift	Yes
Table Dimensions	W: 47.5" x D: 20" (Adjustable Height)

### Our Support Guarantee

At Sailrite, we are committed to helping you get the most out of your Fabricator Sewing Machine. That's why we are proud to offer you personalized support for the lifetime of your machine. We'll be here to help you service your machine with in-depth videos, one-on-one support, and Sailrite's 2-year limited warranty. Should you need them, we have replacement parts in stock and ready to ship out to you and, if necessary, you can always send your machine back to us for repairs.

For complete warranty information visit [Sailrite.com/Warranties](http://Sailrite.com/Warranties)

**\$1,399<sup>00</sup>**

### SAILRITE FABRICATOR

With Power Stand & Workhorse Servo Motor

110V #400500

220-240V #400501

See the Fabricator in action at [Sailrite.com](http://Sailrite.com)

# SAILRITE PROFESSIONAL SERIES

## Zigzag/Straight Stitch Sewing Machines

The Sailrite Professional Sewing Machines are a versatile pair of full-sized industrial walking foot sewing machines that are ready to take on your big projects. Choose from two great models: the standard 10.75" arm and a 20.5" long arm. The Professional was designed for sailmaking, but can also be used for tent and canvas projects.

Built with high-quality parts, you can expect smooth sewing and excellent longevity from these machines as well as easy handling, powerful feeding and great stitch consistency. The Professional sews in a 4-point zigzag stitch, the standard in modern sailmaking. The extra wide (up to 10 mm) 4-point stitch is a time saver and less likely to snag than the traditional 2-point zigzag. Every Professional Sewing Machine is carefully tuned and adjusted by Sailrite technicians for excellent performance.

### STANDARD FEATURES:

- Workhorse Servo Motor
- Mechanical Walking Presser Foot
- Maximum 10 mm Zigzag Stitch
- 7/16" Foot Height
- Patented Posi-Pin Clutching System
- Stitch PRO Balance Wheel

### RECOMMENDED FOR:

#### Sailrite Professional

- Sailmaking (small to medium sized sails)
- Marine Canvas

#### Sailrite Professional Long Arm

- Sailmaking (large sails)
- Commercial Awnings
- Tents
- Marine Canvas



All Sailrite Professional sewing machines come standard with all the great features seen here and more. See a full components list on p.117.



**WALKING FOOT**

Extra wide walking foot ensures positive feeding at up to 10 mm zigzag stitch and moderate straight stitch length. Perfect for spongy and stepped layered fabric assemblies.



**B. STITCH PRO BALANCE WHEEL & BOBBIN WINDER**

Our exclusive Stitch PRO Balance Wheel works with the motor to provide maximum power transfer, even at slower speeds, giving you ultimate control with no power loss. Each machine also features a separate bobbin winder so you can wind bobbins quickly and easily without unthreading the machine.

**E. DELUXE INDUSTRIAL THREAD STAND**

The sturdy, Deluxe Industrial Thread Stand can hold two cones of thread. Thread gets pulled off the top of the cone for proper thread twist and tension. Accommodates up to 16 oz. thread cones.

**LARGE ROTARY HOOK**

Large rotary hook and bobbin mechanism reduces bobbin winding frequency and allows for use of heavier thread (up to size V-138).

**C. TABLE**

High quality k-leg table and power stand that includes a presser foot pedal lift, machine support pin, oil pan and drawer.

**D. PRESSER FOOT PEDAL LIFT**

A Convenient hands-free way to lift the sewing machine presser foot.

**A. WORKHORSE SERVO MOTOR**

Sailrite's 3/4 horsepower Workhorse Servo Motor offers fluid power and high torque, even from a complete stop. Adjustable speed settings let you select the top sewing speed while maintaining variable speed control.

**WITH THE SAILRITE PROFESSIONAL, YOU GET THE POWER & VERSATILITY TO SEW...**



Heavy Canvas Applications  
(8 layers of canvas + 1 layer of clear vinyl)



Light Sail Sewing  
(2 layers 0.75oz Ripstop Nylon)



Heavy Sail Applications  
(6 layers 8.4oz + Boltrope Tape + Tubular Webbing)

SPECIFICATIONS	STANDARD	LONG ARM
Shuttle	Full Rotary (Gear Driven)	Full Rotary (Gear Driven)
Power	Workhorse Servo Motor	Workhorse Servo Motor
Sewing Speed	Stitch-by-Stitch to 1,108spm	Stitch-by-Stitch to 1,108spm
Max. Straight Stitch	5 mm long	5 mm long
Max. Zigzag Stitch	4-point: 10mm, 2-point: 8mm	4-point: 10mm, 2-point: 8mm
Needle Bar Stroke	33 mm	33 mm
Needle System	UY 128 GAS	UY 128 GAS
Bed Size	18.75" x 7"	28.75" x 7"
Underarm Space	10.75" x 4"	20.5" x 4"
Presser Foot Lift	Hand 8mm, Pedal 11mm	Hand 8mm, Pedal 11mm
Bobbin Size	Style M (Dia: 25.7 mm, H: 10.4 mm)	Style M (Dia: 25.7 mm, H: 10.4 mm)
Needle Size	#10 – #22	#10 – #22
Thread Range	V-30 to V-138	V-30 to V-138
Lubrication	Manual	Manual
Table Dimensions	W: 47.5", D: 20" (Adjustable Height)	W: 47.5", D: 20" (Adjustable Height)

**4-POINT (3-STEP) MACHINES**

Every Professional Sewing Machine is fitted with a 4-point cam to sew a 4-point (3-Step) zigzag stitch. This can reduce the number of sewing passes required per seam which is especially useful for spinnakers and on-design sailmaking. All machines also come with a 2-point cam that can easily be switched out for sewing a traditional 2-point zigzag stitch.

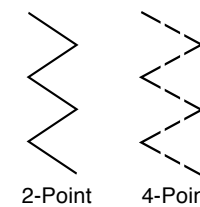

**OUR SUPPORT GUARANTEE**

At Sailrite, we are committed to helping you get the most out of your Sailrite Professional Sewing Machine. That's why we are proud to offer you personalized support for the lifetime of your machine. We'll be here to help you service your machine with in-depth videos, one-on-one support, and Sailrite's 2-year limited warranty. Should you need them, we have replacement parts in stock and ready to ship out to you and, if necessary, you can always send your machine back to us for repairs.

For complete warranty information visit [Sailrite.com/Warranties](http://Sailrite.com/Warranties)

**WHERE ARE THE PROFESSIONAL SEWING MACHINES MADE?**

The Professional sewing machines are assembled in the United States using high quality parts from around the world.



**SAILRITE PROFESSIONAL PACKAGES INCLUDE:**

- A** Sailrite Workhorse Servo Motor (110V)
- B** Sailrite Stitch PRO Balance Wheel with Patented Posi-Pin Clutch System
- C** Industrial Tabletop & K-legs
- D** Presser Foot Pedal Lift
- E** Industrial Thread Stand
- F** 4-Point Zigzag Cam (comes installed)
- G** Flex20 LED Light (110V)
- 2-Point Zigzag Cam
- Oil
- Maintenance Brush
- 3 Screwdrivers
- 4 oz. V-92 Thread
- 50 Assorted UY 128 GAS Needles
- 3 Large Capacity Bobbins
- Seam Ripper
- Allen Wrench Assortment
- Combo Wrench (#8 / #10)
- Flex20 LED Light (110V)

All packages also include the Sailrite Professional Guidebook

**\$3,495<sup>00</sup>**

Sailrite Professional With Power Stand & Workhorse Servo Motor #500500

**\$4,995<sup>00</sup>**

Sailrite Professional Long Arm With Power Stand & Workhorse Servo Motor #500600



See the Professionals in action at [Sailrite.com](http://Sailrite.com)

Patented Posi-Pin #7438009

# SEWING MACHINE SUPPLIES

**POSITRACTION BELTS**  
Ridged, amber colored belts. Teeth allow belt to conform tightly around small grooved pulleys. Do not engage with other teeth. For correct size, measure the current belt (fold in half and double the distance between the ends) or measure around the drive pulley (wrap string around drive pulley and measure string length). Used on Mini-Walker, Apprentice, Sailmaker, SR200, and Yachtsman sewing machines.

- 20-3/8" Circ. **#6411 \$7.50 EA**
- 19-3/4" Circ. **#2301 \$6.95 EA**
- 15-1/2" Circ. **#364 \$5.95 EA**
- 15" Circ. **#366 \$5.25 EA**
- 14-3/8" Circ. **#38101 \$4.95 EA**

**POWER TWIST V-BELT**  
Durable link V-belt with interlocking links to allow for variable belt lengths. Add or remove links to change belt circumference. 3L belt profile. Used on Sailrite 111 and Professional sewing machines sold before 2017.

**#100815 \$21.95/FT**

**COGGED FLYWHEEL BELTS ULTRAFEED**  
Ultrafeed machines require a cogged belt for the jack drive and balance wheel. Belts do not stretch or slip. Black or white.

- 18.6" Circ. (Power Plus & Monster II) **#56535 \$9.95 EA**
- 13" Circ. (Red & Blue Wheels) **#5265 \$7.95 EA**
- 8" Circ. (Jack Drive) **#56539 \$6.95 EA**

**NEW COGGED TIMING BELT 42"**  
This toothed balance wheel belt won't slip or stretch and is the standard belt used on Sailrite sewing machines using the Workhorse Servo Motor. 42" Circumference.

**#120580 \$20.95 EA**

**SEWER'S AID LUBRICANT**  
Silicone lubricant for thread guides, tension mechanisms, needles (smoother sewing), and presser feet (smooth gliding over fabric). Apply sparingly. 1/2 fluid oz. squeeze bottle.

**#138722 \$3.95 EA**

**MAGNETIC THREAD OILER**  
Reduce thread shredding and adhesive build-up. Helps make thread tension more consistent. Set or screw on top of machine and run thread through reservoir. Use with Sewers Aid silicone lubricant (#138722).

**#102810 \$19.95 EA**

**SEWING MACHINE OIL**  
Excellent oil for any sewing machine. Avoid lubricating products that contain kerosene. Use only sewing machine oil for your sewing machine! Oil is clear.

- 4 oz. Bottle + Zoom Spout **#14202 \$3.95 EA**
- 32 oz. Bottle **#23800 \$11.95 EA**

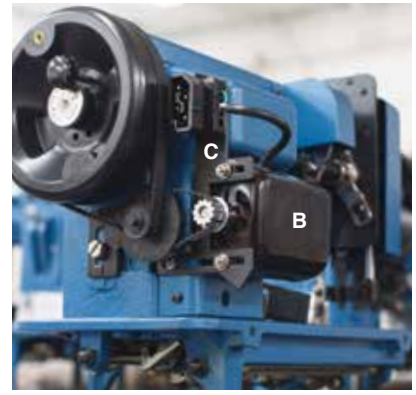

## ULTRAFEED SEWING MACHINE MOTORS

Ideal as a back-up motor for long term cruisers. Poles 2, Input 150W, Output 75W, A.C. 50/60 Hz, 8 mm pulley shaft.

**110 VOLT MOTOR:** 1.5 Amps, RPM 6600/6000.

- B. End Stud Mount, 4-pin female socket** **#102630 \$49.95 EA**  
Side or End Stud Mount, AC plug end **#W003Z-26 \$49.95 EA**

**230 VOLT MOTOR:** 0.7 Amps, RPM 8200/7800.

- End Stud Mount, 4-pin female socket **#102731 \$49.95 EA**

**C. MOTOR BRACKET:**  
Use with #102630 & #102731. **#102712 \$8.95 EA**

## ROPING/ZIPPER PRESSER FEET

Use to sew ZIPPERS and BOLTROPES.

COMPATIBLE MACHINES	FOOT	FOOT POS.	NEEDLE POS.	SHANK	PART #	PRICE
• Sailrite Ultrafeed LS-1		Left	Right	-	<b>#905</b>	<b>\$29.95 EA</b>
		Right	Left	-	<b>#904</b>	<b>\$29.95 EA</b>
• Sailrite Ultrafeed LSZ-1		Left	Right	-	<b>#896</b>	<b>\$29.95 EA</b>
		Right	Left	-	<b>#909</b>	<b>\$29.95 EA</b>
• Sailrite Fabricator • Sailrite 111 • Sailrite Big-N-Tall • Consew 206RB • Juki 1541		Left	Right	-	<b>#368123</b>	<b>\$19.95 EA</b>
		Right	Left	-	<b>#376123</b>	<b>\$19.95 EA</b>
• Sailrite Professional		Left	Right	-	<b>#100922</b>	<b>\$38.40 SET</b>
• Sailrite Sailmaker • Sailrite Long Arm • Sailrite Yachtsman • SR200 • Singer 20U		Left	Right	High	<b>#14201</b>	<b>\$8.95 EA</b>
		Right	Left	High	<b>#14203</b>	<b>\$8.95 EA</b>

## CORDING PRESSER FEET

Use to sew CORDING/PIPING and WELTING.

COMPATIBLE MACHINES	FOOT	SIZE	FOOT POS.	NEEDLE POS.	SHANK	PART #	PRICE
• Sailrite Sailmaker • Sailrite Yachtsman • Home machines (high shank) • Sailrite Long Arm • SR200		3/16"	Left	Right	High	<b>#102258</b>	<b>\$14.95 EA</b>
		1/4"	Left	Right	High	<b>#102260</b>	<b>\$14.95 EA</b>
		1/8"	Right	Left	High	<b>#102262</b>	<b>\$14.95 EA</b>
		1/4"	Right	Left	High	<b>#102263</b>	<b>\$14.95 EA</b>
• Ultrafeed LSZ-1		1/4"	-	-	-	<b>#104854</b>	<b>\$33.00 SET</b>
• Sailrite Fabricator • Sailrite 111 • Sailrite Big-N-Tall • Consew 206RB • Juki 1541		1/8"	-	-	-	<b>#103278</b>	<b>\$29.95 SET</b>
		3/16"	-	-	-	<b>#103281</b>	<b>\$29.95 SET</b>
		1/4"	-	-	-	<b>#384123</b>	<b>\$29.95 SET</b>

## DOUBLE CORDING PRESSER FEET

Use to sew DOUBLE CORDING/PIPING/WELTING.

COMPATIBLE MACHINES	FOOT	PART #	PRICE
• Ultrafeed LS-1		<b>#120121</b>	<b>\$35.95 EA</b>
• Sailrite Fabricator • Sailrite 111 • Sailrite Big-N-Tall		<b>#120119</b>	<b>\$29.95 EA</b>

## ZIGZAG ROLLER PRESSER FOOT

Use to sew STICKY MATERIAL, WINDOW MATERIAL and LEATHER.

COMPATIBLE MACHINES	FOOT	PART #	PRICE
• Sailrite Sailmaker • SR200 • Long Arm machines • Non-walking foot machines • High shank machines		<b>#38109</b>	<b>\$6.95 EA</b>

## LEATHER PRESSER FEET

Reduces marring and increases lift height. Use to sew LEATHER and DELICATE FABRICS.

COMPATIBLE MACHINES	FOOT	PART #	PRICE
• Ultrafeed LS-1		<b>#120183</b>	<b>\$31.95 EA</b>
• Ultrafeed LSZ-1		<b>#120184</b>	<b>\$31.95 EA</b>

# LEARN FROM OUR SEWING INSTRUCTORS

Sew along with us when you watch our step-by-step video instructions! Our tutorials break down projects big and small so you can sew with confidence.

Browse hundreds of how-to videos, tips, instructions and more in our how-to library at [Sailrite.com/how-to](http://Sailrite.com/how-to).



### FEED DOGS

Feeds fabric through machine while sewing. A new sharp feed dog can improve fabric feeding.

	Ultrafeed LS-1 & Mini Walker	#W011	\$24.95 EA
	Ultrafeed LSZ-1	#W011Z	\$24.95 EA
	Screw for Ultrafeed Feed Dog (2 required)	#A078	\$2.95 EA
	Sailrite Fabricator, Sailrite 111	#100387	\$24.95 EA
	Professional	#100854	\$24.95 EA
	Screw for Professional Feed Dog (2 required)	#100856	\$2.95 EA
	Big-N-Tall	#102717	\$24.95 EA

### TENSION ASSEMBLY

Controls the amount of thread tension on the upper thread.

	Ultrafeed	#8511	\$25.95 EA
	Sailrite Fabricator, Sailrite 111	#103297	\$29.00 EA
	Professional	#102238	\$29.95 EA

### METAL BOBBINS

Holds thread used on the underside of the sewing machine.

	Class 15; Ultrafeed, Yachtsman, Mini-Walker, Apprentice, Reeds, and home machines	#123100	\$4.00 PK10
	Sailrite Fabricator, Sailrite 111 & Sailrite Professional, Juki 1541, Consew 206RB	#651123	\$4.95 PK5
	Sailrite Sailmaker, SR 200, Long Arm, Singer 20U	#38110	\$3.95 PK5

### BOBBIN CASES

Holds thread bobbin on the underside of the sewing machine.

	Class 15 Bobbin Case: Ultrafeed & Home Machines	#1232	\$11.95 EA
	Bobbin Case: Sailrite Fabricator, Sailrite 111	#100742	\$19.95 EA
	Bobbin Case: Professional	#100864	\$19.95 EA

### ROTARY & SHUTTLE HOOKS

Picks up the thread loop formed by the needle on its upward swing. Critical component to machine operation. Damage to the point of the hook can cause skipped stitches, broken thread, or tension inconsistency.

	Shuttle Hook: Ultrafeed	#9601	\$15.95 EA
	Shuttle Driver: Ultrafeed	#W172	\$19.95 EA
	Rotary Hook: Sailrite Fabricator, Sailrite 111	#110742	\$29.95 EA
	Rotary Hook: Professional	#100857	\$96.00 EA

### TAKE-UP SPRINGS

	Ultrafeed	#5332	\$4.95 EA
	Sailrite Fabricator, Sailrite 111	#20129	\$5.95 EA
	Professional	#100862	\$5.95 EA

### ELECTRONIC FOOT CONTROLS

Made with tough polymeric material that does not rust or corrode. Allows for excellent variable speed control. Electronic controls with grounded wiring (4-pin female plug socket) include longer cord from foot control to plug for greater convenience.

	Grounded Wiring (Use with #102630)	110 V	#102594	\$39.95 EA
	Wiring & Duplex Outlet (Use with #W003Z-26)	110 V	#108401	\$38.90 EA
	No Wiring	110 V	#59625	\$25.95 EA
	Grounded Wiring (Use with #102731)	220-240 V	#102730	\$47.95 EA

### RHEOSTAT CARBON PILE FOOT CONTROL

	Replacement for original Mercury brand rheostat. Works well but gets hot and makes arching noises. Vented metal casing. Wiring not included.	#38112	\$15.95 EA
--	--	--------	------------

### DUPLEX OUTLET & WIRING

	Features a rectangular duplex outlet block (standard 2-pin plug).	#38518	\$12.95 EA
--	---	--------	------------

### PULLEYS

	Motor Pulley I.D.: 8 mm for Ultrafeeds	#W062-1	\$10.00 EA
	Idler Pulley for Ultrafeeds (Use with #W059 & #W061-1)	#W061-A	\$19.95 EA
	Idler Pulley Shaft Non-Stepped	#W061-1	\$4.95 EA
	Idler Pulley Bracket: Ultrafeed (Use with #W061-A)	#W059	\$9.95 EA
	<b>NEW</b> 21-Tooth Cogged Motor Pulley for Workhorse Servo Motor	#120811	\$19.95 EA
	<b>NEW</b> 60mm Pulley for Workhorse Servo Motor	#120812	\$19.95 EA

### BALANCE WHEELS

Large diameter wheels slow down the machine and increase power. Small diameter wheels allow for more speed but offer less power. All new wheels are machined to function with the Posi-Pin.

	Small Diameter Red: LS-1	#W060	\$24.95 EA
	Small Diameter Blue: LSZ-1	#W060Z	\$24.95 EA
	Large Diameter: Power Plus (standard with Ultrafeeds)	#100181	\$29.00 EA
	Large Diameter: Monster II w/Hand Crank & Belt (p.105)	#604U	\$125.00 EA
	<b>NEW</b> Stitch PRO (Fabricator & 2017 Professional or Newer)	#107161	\$149.95 EA

### BELT COVERS

Protective guard to keep fingers from being pinched by the drive belts.

	<b>NEW</b> Belt Cover & Bracket for Workhorse Servo Motor	#120810	\$19.95 EA
	<b>NEW</b> Belt Cover & Bracket for Professional & Fabricator	#120616	\$19.95 EA
	<b>NEW</b> Belt Cover & Bracket for Ultrafeed with Workhorse Servo Motor	#120930	\$19.95 EA
	Small Diameter Wheel: LS-1	#102628	\$24.95 EA
	Small Diameter Wheel: LSZ-1	#102631	\$24.95 EA
	Belt Cover for Large Diameter Wheel (Ultrafeed)	#W050BL	\$24.95 EA

### POSI-PIN

Operate with Sailrite Monster II, Power Plus, Stitch PRO or small diameter balance wheels. All new wheels are machined to function with the Posi-Pin (identified by hole through face of wheel). A free video on how to upgrade your Ultrafeed is available at Sailrite.com on the Posi-Pin product page (#102043).

	Posi-Pin	#102043	\$13.30 EA
	Posi-Pin Nut	#100536	\$17.95 EA
	Posi-Pin Bushing (Ultrafeed)	#100537	\$39.95 EA
	<b>NEW</b> Posi-Pin Bushing (Fabricator, 111 & Professional)	#120624	\$39.95 EA
	Bushing Set Screw (2 required)	#713100	\$0.30 EA
	3/32" Allen Wrench	#102264	\$0.40 EA

### RETAINING RING ULTRAFEED

Bent needles may create a burr on the retaining ring cap spring causing skipped stitches or broken thread. Easy to install (with two screws) and a spare may come in handy.

	Retaining Ring Cap Spring	#1603	\$5.95 EA
	Retaining Ring Screw (2 required)	#102496	\$2.95 PK2
	Retaining Ring Clips	#123011	\$9.95 PAIR

### NEEDLE PLATES

Supports fabric where needle penetrates the cloth. Needle plate is very close to the needle and can be broken or damaged by a needle strike. A bend or break in the plate can cause the machine to skip stitches.

Compound feed machines, like the Sailrite 111 and Big-N-Tall, have a needle that moves with the fabric. The needle plate seldom breaks but can if the feed dog comes loose and jams violently.

	Ultrafeed LS-1 (engraved seam allowance markings)	#W032	\$14.95 EA
	Ultrafeed LSZ-1 (engraved seam allowance markings)	#W032Z	\$14.95 EA
	Screw for Ultrafeeds (2 required)	#A052	\$2.95 EA
	Sailrite Fabricator, Sailrite 111 (engraved seam allowance markings)	#110743	\$14.95 EA
	Professional	#100863	\$16.95 EA
	Screw for Professional (2 required)	#100855	\$2.95 EA

# THREAD STANDS

A thread stand enables a smooth feed off the top of a large cone of thread, eases tension problems, and adds an extra twist in the thread which adds strength and helps keep the thread from unlaying.

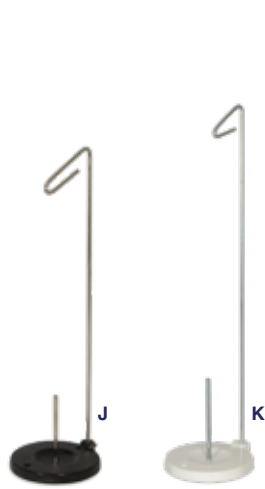

## THREAD STANDS

Accommodates a single thread cone (up to 16 oz.).

- J Metal Base Stand #838100 \$8.95 EA
- K Plastic Base Stand #18303 \$6.95 EA



## INDUSTRIAL THREAD STANDS

Mount directly to any table top (drilling required). Includes platform for 2 thread cones (up to 16 oz.). Deluxe stand is sturdier and is the exact model included with the Sailrite Fabricator Sewing Machine.

- L Standard #100552 \$12.95 EA
- M Deluxe #103724 \$14.95 EA



# Integrated Thread Stand

Conveniently Ready to Use & Quick to Store!

Fastens to the Industrial Carrying Case, the Deluxe Carrying Case, Ultrafeed Wooden Base, or any sewing table and pivots to ideal thread feeding position. Thread feeds smoothly with no tangling, wobbling, or bobbling! Loosen and re-tighten thumb screw to pivot. Accommodates up to 16 oz. cone. May require drilling a 5/16" hole in case or table top (newer Sailrite cases and bases are predrilled). Tough thermoplastics with stainless steel hardware. The Integrated Thread Stand is included with all Ultrafeed® PLUS and PREMIUM sewing machines.

Integrated Thread Stand #103658 \$25.95 EA

Extra Threaded Insert & Hex Key #104152 \$2.00 EA

# BINDERS

Attach to your sewing machine to quickly and easily install binding tape to the edges of enclosures, awnings, dodgers, biminis, and bags. Binder attachments automatically guide and fold tape into place over the edge of fabric. Simply screw into the sewing machine bed (most sewing machines already have the appropriate 6-40 threaded holes).

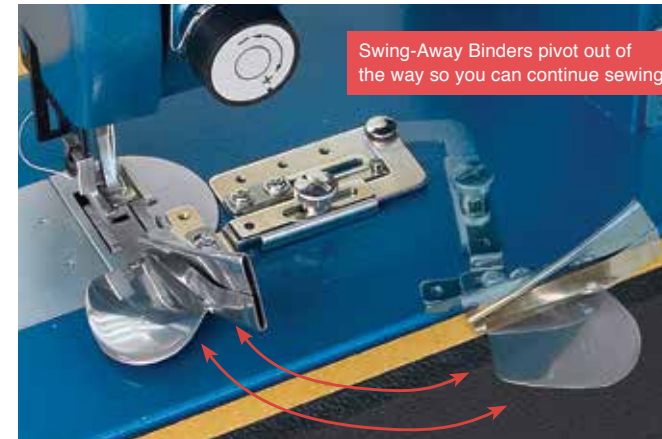

## SWING-AWAY BINDER ATTACHMENTS

Use with appropriate sized acrylic, Stamoid, and vinyl binding tapes (1" binders also handle 7/8" centerfold tape). Just swing away after use to continue sewing. Includes attachment screws. Use this binder with a fabric assembly that will compress to about 3.6mm thick.

- 3/4" Swing-Away Straight Binder #100102 \$59.00 EA
- 1" Swing-Away Straight Binder #100103 \$69.00 EA



## 2" SWING-AWAY BINDER ATTACHMENT

Versatile, heavy duty binder! Use to attach 2" facing or flat webbing around a fabric edge to support fasteners and grommets or install 2" Dacron tape on a sail edge (even with leech line!). Make custom piping (with a left roping zipper foot) by feeding 5/32" piping cord into 2" wide fabric through the binder.

After sewing, cut tail down to 3/8" width so it can easily bend around corners. Just swing away after use to continue sewing. Special screw stop prevents binder from pulling into the needle during heavy sewing. Perfect for home or commercial use. Use this binder with a fabric assembly that will compress to about 5mm thick.

#102582 \$125.00 EA

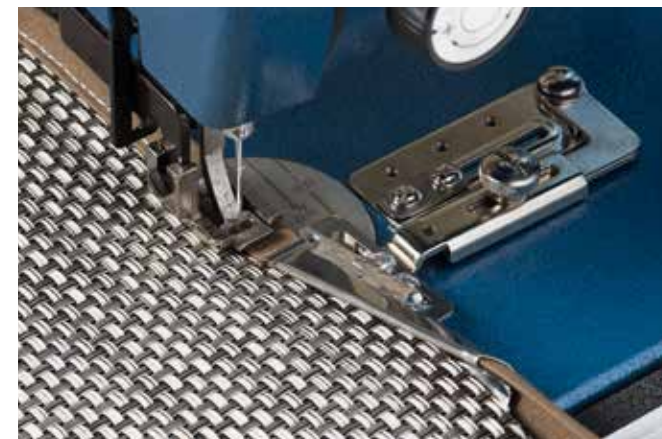

## 1-1/4" SWING-AWAY STRAIGHT BINDER

Our 1-1/4" binder was specially designed with a wider jaw to easily accommodate thicker canvas assemblies, marine flooring or any material that can compress to 5mm. Made in Japan for excellent quality. The swing bracket doesn't need to be removed after use, just swing out of the way! Can be used with 1-1/4" binding tape. Use this binder with a fabric assembly that will compress to about 5mm thick.

1-1/4" Swing-Away Straight Binder #120474 \$89.00 EA



### MAKE YOUR OWN BINDING TAPE

Binding Tape Maker (p.145)

### NEED BINDING?

Find Binding & Facing on p.140-144



# SEWING MACHINE NEEDLES

Sailrite offers a large variety of high quality sewing machine needles. Follow these 3 easy steps to select the right needle for your application.

# 1

Identify which needle system fits your machine:

SEWING MACHINE	NEEDLE SYSTEM
Yachtsman, Apprentice, Home sewing machines (flat shank)	System 130
SR200, Long Arm	135 x 5, 134DI
Sailmaker	16 x 95, DB x 1
Ultrafeed, Fabricator, Sailrite 111, Big-N-Tall, Mini-Walker	135 x 16, 135 x 17
Professional	UY 128 GAS

# 2

Choose the right needle type for your application:



### ROUND POINT (SHARP) NEEDLE

**Round Point (Sharp) Needle** is the most common needle type and can be used for all general sewing. Sharp point and completely round high quality shanks (without burrs that cause broken stitches and separations in thread strands).



### BALL POINT NEEDLE

**Ball Point Needle** is a specialty needle specifically designed for sewing knit fabrics and stretchy materials. The blunt point preserves the elasticity of the fabric by allowing the thread to pass between the fibers of the fabric rather than through them. Completely round high quality upper shanks (without burrs that cause broken stitches and separations in thread strands).



### SD1 NEEDLE

**SD1 Needle** is a specialty needle optimized for fine leather or leather clothing. Works well for heavy sailcloth assemblies. Cutting point is smaller than DI needle. Partially cuts, then pushes fibers out of the way.



### SERV7 NEEDLE

**Serv7 Needle** is a specialty needle with an optimized scarf shape for sewing through heavy fabrics. Perfect for use with Tenara lifetime thread (#14 or 16 recommended). Reinforced blades help avoid skipped stitches and reduce needle breakage. Generally needle size can be one less than normal.



### DI LEATHER NEEDLE

**DI Leather Needle** is a specialty needle designed for working with leather. Optimized for heavy, dry, hard leather. Blade cuts the fibers so that the needle does not have to separate them.

# 3

Select the appropriate needle size:

Needle sizes are listed by size and measurement (in mm x 100 above the scarf). For example, a #12 (80) is a small needle while a #22 (140) is a very large needle. Needle size is directly associated with type of material being sewn.

### Thread & Needle Recommendation Chart

Quickly identify the best needle size and thread for different fabrics. p.245



### SERV7 NEEDLES

135 X 5		
#10 (70)	#100775	\$3.95 PK10
#11 (75)	#100776	\$3.95 PK10
#12 (80)	#100777	\$3.95 PK10
#14 (90)	#100778	\$3.95 PK10
#16 (100)	#100779	\$3.95 PK10
#18 (110)	#100780	\$3.95 PK10
#19 (120)	#100781	\$3.95 PK10

DB X 1		
#10 (70)	#100782	\$3.95 PK10
#12 (80)	#100783	\$3.95 PK10
#14 (90)	#100784	\$3.95 PK10
#16 (100)	#100785	\$3.95 PK10
#18 (110)	#100786	\$3.95 PK10

16 X 95		
#19 (120)	#100787	\$3.95 PK10

135 X 17		
#14 (90)	#100790	\$4.95 PK10
#16 (100)	#100791	\$4.95 PK10
#18 (110)	#100792	\$4.95 PK10
#19 (120)	#100793	\$4.95 PK10
#21 (130)	#100794	\$4.95 PK10
#22 (140)	#100795	\$4.95 PK10

### SD1 NEEDLES

135 X 5		
#12 (80)	#100804	\$5.95 PK10

135 X 17		
#22 (140)	#100806	\$5.95 PK10

### ROUND POINT (SHARP) NEEDLES

SYSTEM 130		
#12 (80)	#20211	\$3.95 PK10
#14 (90)	#20212	\$3.95 PK10
#16 (100)	#20213	\$3.95 PK10
#18 (110)	#20214	\$3.95 PK10
#20 (125)	#20216*	\$3.95 PK10

135 X 5		
#12 (80)	#276	\$3.95 PK10
#14 (90)	#277	\$3.95 PK10
#16 (100)	#278	\$3.95 PK10
#18 (110)	#279	\$3.95 PK10

16 X 95		
#14 (90)	#477	\$3.95 PK10
#16 (100)	#20220	\$3.95 PK10
#18 (110)	#468	\$3.95 PK10
#20 (125)	#20222	\$3.95 PK10
#21 (130)	#479	\$3.95 PK10
#22 (140)	#476	\$3.95 PK10

135 X 17		
#10 (70)	#761	\$4.95 PK10
#12 (80)	#561023	\$4.95 PK10
#14 (90)	#5010	\$4.95 PK10
#16 (100)	#857	\$4.95 PK10
#18 (110)	#4910	\$4.95 PK10
#20 (125)	#7010	\$4.95 PK10
#22 (140)	#153	\$4.95 PK10

UY 128 GAS		
#12 (80)	#120839	\$5.95 PK10
#14 (90)	#106752	\$5.95 PK10
#16 (100)	#106753	\$5.95 PK10
#18 (110)	#106754	\$5.95 PK10
#19 (120)	#106755	\$5.95 PK10
#20 (125)	#106756	\$5.95 PK10
#21 (130)	#106757	\$5.95 PK10
#22 (140)	#106758	\$5.95 PK10
#23 (160)	#106759	\$5.95 PK10

### DI LEATHER NEEDLES

SYSTEM 130		
#16 (100)	#100811	\$3.95 PK5
#19 (120)	#103301	\$3.95 PK5

134DI		
#18 (110)	#100796	\$5.95 PK10
#20 (125)	#100797	\$5.95 PK10

135 X 16		
#18 (110)	#100798	\$5.95 PK10
#20 (125)	#100799	\$5.95 PK10
#21 (130)	#100800	\$5.95 PK10
#22 (140)	#100801	\$5.95 PK10
#23 (160)	#100802	\$5.95 PK10

### BALL POINT NEEDLES

135 X 17		
#14 (90)	#103073	\$4.95 PK10
#18 (110)	#103074	\$4.95 PK10
#20 (125)	#103075	\$4.95 PK10
#21 (130)	#103283	\$4.95 PK10



### NEEDLE ASSORTMENT PACK

Includes: 40 - 135 x 17 Round point needles, deluxe seam ripper, and maintenance brush.

10 each: #14, 16, 18 & 20	#5343	\$23.70 PK
---------------------------	-------	------------

\*Organ brand needle (not Schmetz)



## HAND SEWING NEEDLES

Sailmaking, upholstery and canvaswork projects often have aspects that require hand sewing. Here are a few tips for selecting the right hand sewing needles.

- Sailmakers and canvas workers often prefer to use triangular shank needles to open a large hole to cut down on chafe as they pull long lengths of twine through the fabric.
- Remember, needle size increases as the number decreases.
- A #16 needle is good for most projects.
- Use larger needles for sewing through multiple layers of fabric and smaller needles for seaming.
- Select the needle that creates the smallest hole with the least hassle.

### A OSBORNE HAND NEEDLES

- #14 Needle #29107 \$1.95 EA
- #15 Needle #29106 \$1.95 EA
- #16 Needle #29105 \$1.95 EA
- #17 Needle #29104 \$1.95 EA

### WM & SMITH CO. HAND NEEDLES

The best sailmaker's needles available! Forged in England from cast steel with reduced edges, triangular points, and long eyes for easy threading.

- A #18 Needle #29103 \$2.95 EA
- B 5 Pk. Assortment (#13-19) #29112 \$11.95 PK5
- C 10 Pk. Assortment (#14-18)\* #29113 \$19.95 PK10
- D 20 Pk. Assortment (#14-18)\* #29108 \$35.95 PK20

\*Comes in waterproof tube.

### E DRITZ ASSORTED NEEDLES

Includes 5 assorted German-made straight needles and 2 curved needles for hand sewing. Round shank instead of normal triangular shank.

- #3426 \$2.95 PK7

### F CURVED HAND NEEDLE ASSORTMENT

Includes 1 - 3", 4", 5" and 6" round-point curved needle.

- #100100 \$3.95 PK4

### G HAND NEEDLE ASSORTMENT

Includes 2 curved upholstery needles (2" and 2-1/2"), a large special bent needle for sewing with string or twine, a sailmaker's triangular shank needle, and a carpet needle.

- #100098 \$5.95 PK5

### H LONG UPHOLSTERY HAND NEEDLE ASSORTMENT

Includes 1 - 6", 8", 10", and 12" needle for tufting and button installation.

- #100099 \$3.95 PK4

### I NEEDLE THREADER

Thread hand and sewing machine needles with ease. Aluminum with wire bow.

- #138911 \$1.00 EA

### ADJUSTABLE PALM

by William Smith & Sons

An excellent quality English seaming and roping palm made for long lasting wear and comfort. Features large metal thrusting base with brass cap and molded raw hide palm protection. Shield protects thumb from roping (twine wrapped and pulled hard over thumb). Adjustable buckle strap.

- Right-hand Palm #19201 \$21.95 EA

- J Left-hand Palm #19202 \$21.95 EA



The Speedy Stitcher is great for repairing:

- Camping and outdoor equipment
- Saddles & harnesses
- Athletic equipment
- Sails & mooring covers
- Auto tops & upholstery
- General household repairs

## SPEEDY STITCHER SEWING AWL KIT

Perfect for canvas or leather repairs. Includes: Awl K, #8 straight needle R, #8 curved needle Q, bobbin, 30 yd. skein of coarse waxed twine T, and instructions.

#20090 \$15.25 KIT

### REPLACE & RESTOCK

- L Fine Waxed Tan Twine (180 yd) #17090 \$6.95 EA
- M Fine Tan Bobbin (14 yd) #103352 \$2.95 EA
- N Coarse Waxed Tan Twine (180 yd) #15090 \$10.20 EA
- O Coarse Tan Bobbin (14 yd) #103346 \$2.95 EA
- P #4 Straight Needle (for #17090) #524600 \$5.75 PK2
- Q #8 Curved Needle (for #15090) #113010 \$5.75 PK2
- R #8 Straight Needle (for #15090) #100174 \$5.75 PK2

## POLYESTER TWINE

Primarily used for hand sewing. Typically features a round construction, however #100035 has a flat construction for reduced chafe against fabric. Keep twine well-waxed to increase weather resistance and reduce chafe during sewing. Use a Composition Wax Cup to add wax manually if using un-waxed twine.

**3-PLY:** Double thru #18 hand needle for general seaming.

- S 1 oz. (175 ft.). Un-waxed, round. #29201 \$5.95 EA

**5-PLY:** Double thru #18 or #17 hand needle for sewing 7/8" rings.

- T 81 ft. Waxed, round. #29206 \$2.95 EA
- U 500 ft. Waxed, flat. #100035 \$8.95 EA

**7-PLY:** Double thru #16 or #14 hand needle for sewing larger rings.

- V 1 oz. (82 ft). Un-waxed, round. #29203 \$7.95 EA
- W 8 oz. (660 ft) Un-waxed, round. #29204 \$28.95 EA

**V-346:** Smallest twine size.

- X 1 lb. Waxed, round. #101022 \$56.95 EA

### Y COMPOSITION WAX CUP

Protect un-waxed twine and reduce chafe during sewing.

- #29205 \$1.95 EA

### Z POLYESTER WHIPPING TWINE

Whip line ends with this waxed #4 (0.8 mm) polyester twine. 134 ft. per spool.

- Red #102577 \$7.95 EA
- White #102576 \$7.95 EA
- Blue #102578 \$7.95 EA
- Brown #102579 \$7.95 EA



## ANTIWICK THREAD

Smooth, bonded V-92 polyester thread with wax coating that is specifically designed to prevent weeping seams! A wax coating on the thread plugs stitch holes to help waterproof seams in canvas and vinyl and increases UV resistance over UVR polyester thread. High strength and stretch control, stability in sunlight (UVR), and resistance to needle heat, abrasion, salt-water and mildew. Use with a #18 or #20 needle on 6–10 oz. fabrics. 8 oz. cones (2,250 yds).

White #103707 \$30.95 EA

Black #103731 \$32.95 EA



Watch our FREE demo video at [Sailrite.com](http://Sailrite.com)



### MONOFILAMENT THREAD

Very strong, clear nylon thread that sews well (easy to set upper thread tension and tension remains consistent) and blends in with fabrics. Use for upholstery, quilting, tacking, and canvas. Feeds through top of cover which provides silicone coating and keeps thread clean and tangle-free. No thread stand necessary. Includes transparent cover. Approximately 1.5 lb. spool.

WEIGHT	APPLICATION	PART #	PRICE
#18 Light	Quilting & Tacking	#100095	\$38.95 EA
#40 Medium	General Upholstery	#100096	\$37.95 EA
#52 Heavy	Canvas	#100097	\$36.95 EA



▲ The bottom of Profilen thread cones open and snap closed to lock the loose end of the thread in place.

# TWO GREAT LIFETIME THREADS

PTFE, polytetrafluoroethylene, thread won't rot or degrade outdoors and is guaranteed for life! PTFE thread is more expensive than polyester thread, but is a greater value when you consider lifespan and re-stitching costs. Choose a PTFE thread to improve the performance of outdoor fabrics where seam life and integrity are of the utmost importance.

## GORE® TENARA® THREAD

The unique fluoropolymer fiber construction of Tenara thread extends the life of fabric seams and the products in which its used. Tenara, the original lifetime thread, has high strength and durability that has been proven to be unaffected by UV rays, cleaning agents, pollution, saltwater, air, rain and snow. Remains colorfast and flexible even in extreme temperatures and can be left outside year-round. Great for outdoor awning, and marine applications. Works best with rotary hook sewing machines, like the Sailrite Fabricator, the Sailrite 111, the Sailrite Professional Series & the Sailrite Big-N-Tall.

### TENARA M1000

Lubricated. Similar in weight to V-92 thread. Breaking strength: 8-10 lb. Use with a #14 or #16 needle. 8 oz. cones (1,595 yds).

- Clear\* #16211 \$130.95 EA
- White #10011 \$130.95 EA
- Pacific Blue #100292 \$130.95 EA
- Black #104123 \$130.95 EA
- Sandstone #104985 \$130.95 EA
- NEW Red #121217 \$130.95 EA
- NEW Navy Blue #121215 \$130.95 EA
- NEW Grey #121218 \$130.95 EA
- NEW Forest Green #121216 \$130.95 EA

### TENARA M1000H

Lubricated. Similar in weight to V-138 thread. Breaking strength: 15 lb. Use with a #18 or #20 needle. 8 oz. cones (950 yds).

- Clear\* #103320 \$129.95 EA
- White #103315 \$129.95 EA
- Black #103317 \$129.95 EA

## PROFLEN® PTFE LIFETIME THREAD

Recommended by Sailrite for use with Ultrafeed® Sewing Machines

A high-performance PTFE thread that is unaffected by UV rays and harsh weather. Profilen thread is dirt and water repellent and has self-cleaning properties. It has a lifetime guarantee and won't rot or degrade. This PTFE thread is flexible and resilient as well as non-flammable, fade proof and chemical resistant. Profilen Thread is softer than other PTFE threads which makes it easier to sew properly. Highly recommended for use in oscillating hook sewing machines, like the Ultrafeed. Breaking strength: 7.9 lb. Size is similar to V-92. Use with a smaller needle (#18 to #20).

### 4OZ CONE (820 yds)

- Clear\* #107128 \$75.95 EA
- Black #107130 \$75.95 EA

### 8OZ CONE (1,640 yds)

- Clear\* #107129 \$130.95 EA
- Black #107131 \$130.95 EA

### MATCHING THREAD COLORS TO SUNBRELLA®

See our Tenara and Profilen thread color recommendations for Sunbrella solids. p.246



## UPHOLSTERY THREAD

Choose a nylon thread for all your upholstery needs. Nylon offers better elasticity than polyester, making it last longer for interior applications. Polyester thread is still the go-to choice for outdoor applications as it offer better UV resistance.

### ANEFIL UV NYLON UPHOLSTERY THREAD BY A&E

Twisted multifilament nylon thread. Good abrasion resistance, excellent seam strength, and superior sew ability. Bonded finish gives consistent diameters and ply security. Added UV inhibitors make Anefil more UV resistant than typical nylon threads. Perfect for auto or furniture upholstery, leather, luggage, handbags and more. Made in the USA.



PLATINUM WHITE    BEIGE    OLD GLORY RED



BLACK    NAVY    WALNUT

### V-69 THREAD

Platinum White	4 oz.	1,500/yd	#106130	\$12.95 EA
Black	4 oz.	1,500/yd	#106137	\$12.95 EA
Beige	4 oz.	1,500/yd	#106134	\$12.95 EA
Old Glory Red	4 oz.	1,500/yd	#106143	\$12.95 EA
Navy	4 oz.	1,500/yd	#106140	\$12.95 EA
Walnut	4 oz.	1,500/yd	#106146	\$12.95 EA

### V-92 THREAD

Platinum White	4 oz.	1,074/yd	#105995	\$13.95 EA
Platinum White	16 oz.	4,296/yd	#105997	\$36.95 EA
Black	4 oz.	1,074/yd	#106013	\$13.95 EA
Black	16 oz.	4,296/yd	#106003	\$36.95 EA
Beige	4 oz.	1,074/yd	#105998	\$13.95 EA
Old Glory Red	4 oz.	1,074/yd	#106007	\$13.95 EA
Navy	4 oz.	1,074/yd	#106004	\$13.95 EA
Walnut	4 oz.	1,074/yd	#106010	\$13.95 EA

### V-138 THREAD

Platinum White	4 oz.	729/yd	#106014	\$13.95 EA
Platinum White	16 oz.	2,916/yd	#106016	\$37.95 EA
Black	4 oz.	729/yd	#106020	\$13.95 EA
Black	16 oz.	2,916/yd	#106022	\$37.95 EA
Beige	4 oz.	729/yd	#106017	\$13.95 EA

# UVR POLYESTER THREAD

Rest assured that we carry the best polyester thread we can find! We offer three great brands of thread perfect for sail and canvas work. All polyester thread is bonded with high strength and stretch control, UV resistant and made for a marine environment. Sunstop threads also feature a non-wicking finish to help control moisture migration and their colors are exact matches to Sunbrella fabrics. Pre-wound polyester bobbins on p.131.

## COATS POLYESTER THREAD

### V-30 THREAD

White	1 oz.	725 yds	#20201	\$9.95 EA
White	16 oz.	12,000 yds	#20206	\$32.95 EA

### V-46 THREAD

White	1 oz.	600 yds	#20202	\$9.95 EA
-------	-------	---------	--------	-----------

### V-69 THREAD

White	1 oz.	350 yds	#20203	\$6.95 EA
Derby Navy	4 oz.	1,400 yds	#103795	\$15.95 EA
Seal Brown	4 oz.	1,400 yds	#104338	\$15.95 EA
Spruce Green	4 oz.	1,400 yds	#103321	\$15.95 EA
Black	1 oz.	350 yds	#20225	\$6.95 EA

### V-92 THREAD

White	1 oz.	250 yds	#20204	\$6.95 EA
Scarab	4 oz.	1,000 yds	#103035	\$14.95 EA
Blue	4 oz.	1,000 yds	#103033	\$14.95 EA
Pebble Beige	4 oz.	1,000 yds	#100074	\$14.95 EA

## SUNGUARD POLYESTER THREAD

### V-92 THREAD

Oyster	4 oz.	1,000 yds	#103027	\$15.95 EA
Concord	4 oz.	1,000 yds	#103028	\$15.95 EA
Sunflower Yellow	4 oz.	1,000 yds	#103029	\$15.95 EA
Blue Wave	4 oz.	1,000 yds	#103030	\$15.95 EA

### MATCHING THREAD COLORS TO SUNBRELLA®

See our V-69 & V-92 thread color recommendations for Sunbrella solids. p.246

### THREAD & NEEDLE RECOMMENDATION CHART

Quickly identify the best needle size and thread for different fabrics. p.245

## SUNSTOP POLYESTER THREAD By A&E

### V-46 THREAD

White	16 oz.	9,600 yds	#20207	\$29.95 EA
-------	--------	-----------	--------	------------

### V-69 THREAD

White	4 oz.	1,350 yds	#20235	\$11.95 EA
White	16 oz.	5,600 yds	#20208	\$34.95 EA
Natural	4 oz.	1,350 yds	#106135	\$11.95 EA
Silver	4 oz.	1,350 yds	#106138	\$11.95 EA
Cadet Grey	4 oz.	1,350 yds	#106141	\$11.95 EA
Linen	4 oz.	1,350 yds	#106144	\$11.95 EA
Toast	4 oz.	1,350 yds	#106147	\$11.95 EA
Beige	4 oz.	1,350 yds	#106015	\$11.95 EA
True Brown	4 oz.	1,350 yds	#106018	\$11.95 EA
Forest Green	4 oz.	1,350 yds	#106021	\$11.95 EA
Logo Red	4 oz.	1,350 yds	#106024	\$11.95 EA
Jockey Red	4 oz.	1,350 yds	#105428	\$11.95 EA
Burgundy	4 oz.	1,350 yds	#106027	\$11.95 EA
Pacific Blue	4 oz.	1,350 yds	#106030	\$11.95 EA
Captain Navy	4 oz.	1,350 yds	#105999	\$11.95 EA
Navy	4 oz.	1,350 yds	#106002	\$11.95 EA
Navy	16 oz.	5,700 yds	#105468	\$37.95 EA
Black	4 oz.	1,350 yds	#105425	\$11.95 EA
Black	16 oz.	5,600 yds	#413100	\$37.95 EA

### V-92 THREAD

White	4 oz.	1,050 yds	#100079	\$11.95 EA
White	16 oz.	4,000 yds	#20209	\$26.95 EA
Natural	4 oz.	1,050 yds	#106386	\$13.95 EA
Silver	4 oz.	1,050 yds	#106387	\$13.95 EA
Cadet Grey	4 oz.	1,050 yds	#106388	\$13.95 EA
Linen	4 oz.	1,050 yds	#105430	\$13.95 EA
Toast	4 oz.	1,050 yds	#106389	\$13.95 EA
Beige	4 oz.	1,050 yds	#106390	\$13.95 EA
True Brown	4 oz.	1,050 yds	#106391	\$13.95 EA
Forest Green	4 oz.	1,050 yds	#105427	\$13.95 EA
Logo Red	4 oz.	1,050 yds	#106392	\$13.95 EA
Jockey Red	4 oz.	1,050 yds	#105447	\$13.95 EA
Burgundy	4 oz.	1,050 yds	#105429	\$13.95 EA
Pacific Blue	4 oz.	1,050 yds	#106393	\$13.95 EA
Captain Navy	4 oz.	1,050 yds	#106394	\$13.95 EA
Navy	4 oz.	1,050 yds	#100073	\$13.95 EA
Black	4 oz.	1,050 yds	#100071	\$13.95 EA
Black	16 oz.	4,200 yds	#913100	\$27.95 EA

### V-138 THREAD

White	16 oz.	2,700 yds	#20210	\$32.95 EA
Black	16 oz.	2,700 yds	#102236	\$35.95 EA

## SUNSTOP POLYESTER THREAD



## COATS/SUNGUARD POLYESTER THREAD

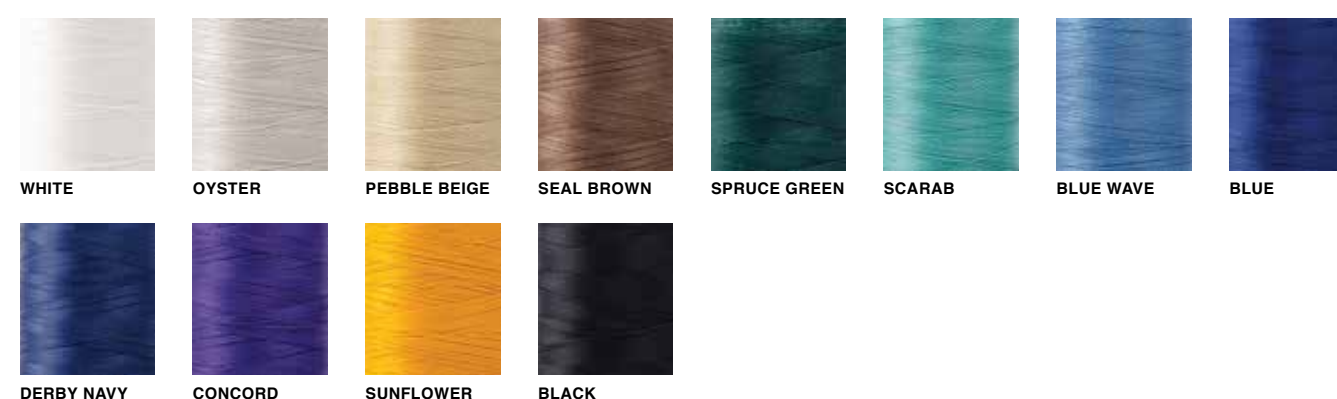

## ABOUT POLYESTER THREAD

Polyester thread fibers can be produced with “spun” (fuzzy) or very smooth fibers. Spun fibers are used in the construction of thread for dressmaking as the fuzzy surface tends to pull through tension devices more consistently than smooth, hard and rather brittle polyester. Spun thread is not nearly as strong as the smooth polyester and as a result is used only for dresses, kites, and the like.

Smooth polyester fibers can have a smooth, soft finish or a bonded finish. A bonded finish protects thread from heat build-up and improves sewability with a special coating that makes the thread slide more easily over metal parts. This bonding also makes stitch tension more controllable.

### HEMBOBS (PRE-WOUND BOBBINS)

Eliminate the need for bobbin winding! Pre-wound polyester thread bobbins. Style (hembob or bellbob) may vary.

#### STYLE M:

Fabricator, Sailrite 111, Professional, Con sew 206 RB1, Juki 241

#### STYLE L:

Sailmaker, SR200, Long Arm, Con sew 98, Phaff 138 & 238

#### STYLE A:

Ultrafeed, Apprentice, Reeds, Yachtsman, Mini-Walker, most home sewing machines



THREAD SIZE	GOV. SIZE	TEXTILE SIZE	TENSILE STRENGTH	NEEDLE SIZE	FABRIC WEIGHT REC.
V-30	AA	30	4.5 lb.	#12 or 14	< 1.5 oz.
V-46	B	45	7.1 lb.	#14 or 16	< 3 oz.
V-69	E	70	10.6 lb.	#16 or 18	3–6 oz. & Sunbrella
V-92	F	90	14.2 lb.	#18 or 20	6–10 oz. & Sunbrella
V-138	FF	135	21.2 lb.	#20 or 22	> 10 oz.

COLOR	WEIGHT	SIZE	LENGTH	PART #	1–11 PK	12+ PK
White	V-92	Style M	39 yd	#100230	\$6.95 PK12	\$6.26 PK12
White	V-92	Style A	25 yd	#625930	\$4.95 PK12	\$4.46 PK12
White	V-69	Style M	48 yd	#103306	\$6.95 PK12	\$6.26 PK12
White	V-69	Style L	24 yd	#102018	\$8.95 PK12	\$8.05 PK12
White	V-69	Style A	33 yd	#102016	\$4.95 PK12	\$4.46 PK12
Black	V-92	Style M	39 yd	#103375	\$6.95 PK12	\$6.26 PK12
Black	V-92	Style A	25 yd	#103381	\$4.95 PK12	\$4.46 PK12
Black	V-69	Style M	48 yd	#103310	\$6.95 PK12	\$6.26 PK12
Black	V-69	Style A	33 yd	#103313	\$4.95 PK12	\$4.46 PK12

## ROTARY CUTTERS & SNIPPERS



### 28 MM ROTARY CUTTER by Fiskars

Great for cutting cloth, paper, leather, vinyl, etc. Ergonomic design makes turning forward, backward, and around corners for detailed jobs and smaller shapes even easier! Safety switch for blade guard.

28 mm Rotary Cutter **#139900 \$9.95 EA**  
2 Replacement Blades **#140100 \$6.95 PK2**



### 60 MM ROTARY CUTTER by Fiskars

Comfort-grip rotary cutter is the safest and easiest tool around. Works naturally with your hand for ultimate comfort and safety. One-size-fits-all handle has easy-action trigger and safety switch for blade guard. Squeeze handle to engage blade.

60 mm Rotary Cutter **#9655 \$28.95 EA**  
Replacement Blade **#41086 \$8.95 EA**



### 45 MM ROTARY CUTTER by Fiskars

This rotary cutter with a titanium-enhanced blade is perfect for cutting thicker or stacked fabrics. It is ergonomically designed for optimal control and can be adjusted for right or left-handed cutting. Thumb lock secures the blade open or closed.

45 mm Rotary Cutter **#107123 \$18.95 EA**  
Replacement Blade **#106949 \$4.95 EA**  
Replacement Blade **#107124 \$23.95 PK5**



### 4" THREAD CLIPPERS by Gingher

Stainless steel, knife edge blades with sharp pointed ends for pulling and snipping threads in tight spots. Protective cap provides safe storage. **#100743 \$17.00 EA**



### ERGONOMIC THREAD SNIPS

Ideal for small and precise cuts. Extra sharp stainless steel blades and soft cushion handles. Fatigue free and perfect for those with arthritis or carpal tunnel syndrome. Fits comfortably in hand. **#102991 \$10.95 EA**



### 4-1/2" THREAD NIPPERS by Gingher

A great accessory! Cut thread quickly and cleanly. Very sharp. Hot drop forged, fully chrome plated. **#104710 \$25.40 EA**



### DELUXE SEAM RIPPER

Open many feet of zigzag stitching in seconds. Supreme quality with narrow beak and protective ball on hook to prevent cutting fabric. Flat handle. 5-1/2" length.

**#18104 \$1.95 EA**

### SELF-HEALING CUTTING MAT by Fiskars

High quality self-healing surface designed for rotary cutters and rotary blades. Easy-to-read measuring grid with 30, 40, and 60 degree bias lines on both sides. Store flat away from sunlight, heat, or cold.

18" x 24" **#102990 \$22.95 EA**  
24" x 36" **#120257 \$43.95 EA**



## SCISSORS



### A CUTS+MORE 5-IN-1 MULTI-PURPOSE SCISSORS by Fiskars

Versatile scissors complete with wire cutter, twine cutter, pointed awl tip, bottle opener, and power notch for cutting light rope. High quality blades ideal for cutting a wide variety of household, office, and garden materials. Comfortable ergonomic handles. Titanium-coated 9" blades come apart for use as a knife. Dishwasher safe. Sheath protects blades, sharpens scissors, and includes a tape cutter for opening boxes. Right handed. **#103578 \$17.95 EA**

### B 7-1/2" PINKING SHEARS by Gingher

Use to produce ravel-resistant edging in sewing or craft work. The resulting zigzag edge makes a nice finish for seams. Nickel-plated chrome. **#100526 \$46.55 EA**

### C 8" LIGHTWEIGHT BENT TRIMMERS by Gingher

Quality craftsmanship assures sharp, smooth cutting action. Recommended for cutting multiple layers of fabric for sewing, crafts, and quilting. Bent handle design makes cutting on tabletop or flat surfaces comfortable and easy. Adjustable tension. Stainless steel blades with black molded nylon handles. Right-handed. **#101017 \$16.40 EA**

### D 8" KNIFE EDGE SHEARS by Gingher

Designed for cutting tough polyester fabrics. Start the initial cut and slide along the fabric for a quick, clean cut. Even works well with slippery nylon and Dacron sailcloth. Knife edge can be resharpened. Chrome-plated shears. Includes storage sheath.

Right-handed **#19104 \$35.45 EA**  
Left-handed **#19105 \$35.45 EA**

### E 8" EASY ACTION BENT SCISSORS by Fiskars

Commended by Arthritis Foundation® for ease of cutting. Spring-action design makes cutting easier. Ergonomic handle for added comfort and control. Precision ground, hardened stainless steel blades. Blade lock for safe storage. **#103337 \$19.95 EA**

### F 10" BENT SCISSORS by Gingher

Large scissors perfect for cutting heavyweight fabrics like industrial upholstery, heavy drapery, leather and Dacron materials. Extra-large bent handle design allows for easier cutting on a tabletop or counter for smooth, comfortable, mistake-free cutting. Knife edge blades can be re-sharpened. Chrome plated. Right-handed. **#120186 \$48.55 EA**

# SAILRITE® CANVAS PATTERNING RULER

Designed exclusively for Sailrite, this ruler lets you easily pattern perfect circles and trace a line a set distance from the edge of a fabric. Clear acrylic ruler has holes every quarter-inch. Lipped metal edge glides along the fabric edge for marking cut lines and seam allowances. Maximum circle radius: 8 inches.

#107040 \$15.95 EA



◀ See the Sailrite Canvas Patterning Ruler in action at [Sailrite.com](http://Sailrite.com)

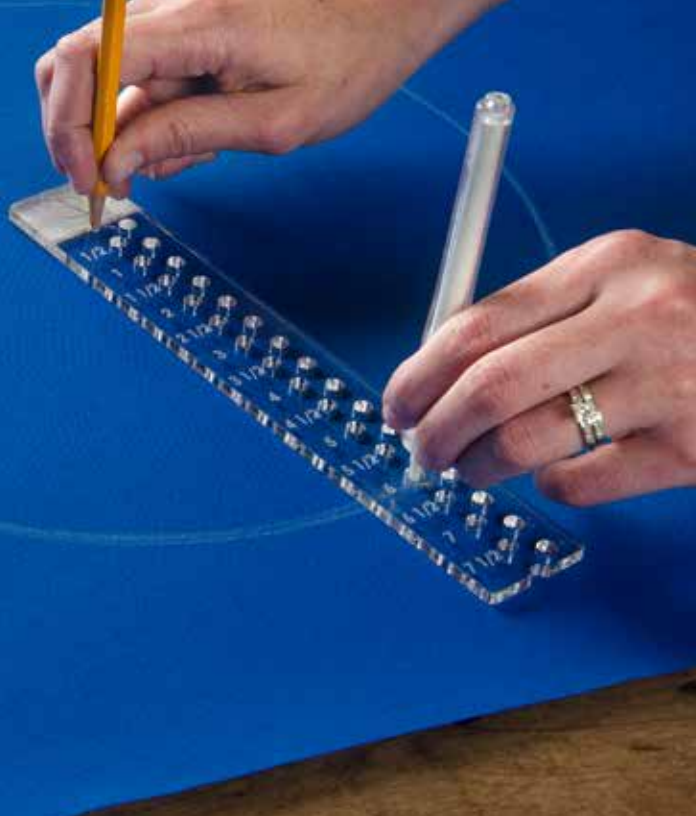

# WORK SMARTER, NOT HARDER

With Helpful Tips from Sailrite

Head over to [Sailrite.com](http://Sailrite.com) and check out our Tips & Tricks section for helpful advice on hand sewing, waterproofing seams, sewing large sails with your Ultrafeed LSZ-1 and much more! Because sometimes, a little tip makes all the difference for your project.

[Sailrite.com/How-To](http://Sailrite.com/How-To)



## MARKING & MEASURING

### CLEAR ACRYLIC RULER 6" X 24"

Designed for cutting long strips and constructing multiple-angle pieces. Right and left-handed. Use with Fiskars Rotary Cutter (p.132).

#102400 \$12.95 EA

### MARKING CHALK (TAILORS CHALK)

Easy to erase, clay-based chalk that works well on fabric, glass, and vinyl. No grease spots! Shape maintains a sharp marking edge. Marks wash or rub away. Box of 12 contains: 8 white, 2 yellow, 1 red, 1 blue.

#102464 \$20.95 EA

### TAPE MEASURE 1/4" X 8"

Executive thin-line pocket type by Lufkin. Power retraction. Markings are jet black on yellow. Polished chrome case with spring action blade return.

#102597 \$26.75 EA

### 120" TAPE MEASURE

Lifetime fiberglass 120" tape measure that features easy to read, large numbers. Will not tear, stretch, shrink, or fade. Washable. Metal tips on both ends.

#102986 \$2.95 EA

### SEWING GAUGE 6" RULER

Serves many uses for the home sewer! Use to measure and mark hem widths, tucks, pleats, scallops, circles, spacing buttons, and buttonholes.

#102995 \$1.95 EA

### WASHABLE BLUE WONDER MARKER

Makes a bright blue mark which is easily removed with plain water. Works great on acrylic fabrics! Not recommended for use on dark fabrics.

#480012 \$3.95 EA

### SCRIBE-ALL WATER SOLUBLE MARKING PENCIL

Truly an all surface pencil! Marks on Sunbrella and other woven fabrics, vinyl, coated fabrics, clear vinyl and more. Removes easily with a damp cloth. Sharpens with any pencil sharpener. 7" pencil length.

Black #120682 \$1.95 EA

White #120681 \$1.95 EA

### WATER SOLUBLE MARKING PENCILS

Safe for all fabrics, these marking pencils wash off easily with a damp cloth. Comfortable and easy to use. Blue and white pencil included for marking on light and dark fabrics.

#106720 \$2.95 PK2

### GREASE MARKING PENCIL

Best used on vinyls and patterning material. Easy to remove from non-porous finishes. Difficult to remove from Sunbrella. Pull string and peel paper from pencil to reveal more marking tip. 7" pencil length.

Black #101027 \$1.35 EA

White #101026 \$1.35 EA

Yellow #111002 \$1.35 EA

### SOAPSTONE PENCIL

A natural, lightweight soapstone pencil used for marking dark fabrics. Safe on all fabrics and washes off easily. Comfortable finger grip and transparent barrel shows the length of remaining soapstone. Sharpen with any pencil sharpener. Includes pencil style case.

Soapstone Pencil #102766 \$4.95 EA

Refill Pencil (2) #102769 \$2.95 EA

### FIND THE BEST MARKING PENCIL FOR YOUR PROJECT

Compare pencils on their ability to mark on various fabrics and surfaces and how easily they can be removed at [Sailrite.com](http://Sailrite.com) #X-HT-300112

## SEWING KITS



### DRITZ START-TO-SEW KIT

Includes: 7" Bent trimmers, hand sewing needles, pencil, needle threader, seam ripper, sewing gauge, pins, tape measure, thimble, pin cushion, tracing paper, and tracing wheel.

#138811 \$9.95 KIT



### SWIVEL BENCH HOOK

Acts as a third hand to help keep canvas, a length of line or other projects taught while you sew. Tie the closed end to a work bench and hook the other end onto your fabric.

#4632 \$4.95 EA



### BOBBIN BOX

Crystal clear, polystyrene bobbin box ingeniously designed with 21 concentric grooved compartments to keep bobbins organized. 6" x 3-3/4" x 1-1/4". Will not hold Big-N-Tall machine bobbins.

#102987 \$4.95 EA



### MAGNETIC BOBBIN HOLDER

No more run away unwinding bobbins! Holds up to 16 steel bobbins tightly on its rim. Keeps bobbin threads from tangling. (Will not fit the Big-N-Tall or Style M bobbin machines, ex. Sailrite Fabricator or Professional). Bobbins not included.

#104612 \$10.95 EA

## PINS

Great way to hold fabric in place while patterning, cutting, and basting. Use T-pins to pin heavy fabrics. Use rust-resistant Clear Twist decorative pins to securely hold arm covers or slip covers in place.



2" T-Pins  
#95848 \$13.95 PK364



1-1/2" Pins  
#102985 \$5.95 PK250



11/16" Aluminum Push Pin  
#102022 \$1.95 PK10



10/16" Plastic Push Pin  
#102021 \$2.95 PK10



Clear Twist Pins  
#102992 \$3.95 PK30

## SEWING GUIDES



### DELUXE MAGNETIC SEWING GUIDE

High strength magnetic sewing guide with extended length! Stays firmly in place. Extended length ensures accurate stitch placement in hems and general seam construction. Turn sideways for applications where a short guide is required. Non reflective matte finish. Made in the USA. Length: 5-1/2". See full details p.104.  
#103597 \$31.95 EA



### MAGNETIC SEWING GUIDE

Over 20 times the holding power of a typical fabric store magnetic sewing guide so it stays put even when used with heavy materials! Strong attachment to metal throat plate on sewing machine to ensure uniform seam width. Offers greater versatility and convenience as it allows for wider seam width positions. Removes easily and quickly.  
#102983 \$17.95 EA



### SWING GAUGE (SEWING FENCE)

Perfect for hemming. Keeps stitches uniformly spaced from the edge of the fabric. Useful only along the edges of an assembly. Assists in the creation of a semi-flat felled seam. Mounts in machines with two threaded screw holes.  
#100439 \$12.95 EA

## ENGEL HOTKNIFE

Seal and cut with precision and perfection! Use on synthetic fabric, webbing, rope, and other materials that ravel when cut with scissors. Controlled heat melts and seals edges and ends. Trigger operated. Heats up in seconds. Light illuminates area being cut. Cool, comfortable hand grip and rapid cool down for increased safety. Built to last for years. 110V and draws 70 watts. Cord length: 6.23 ft. Blades sold separately.

Engel Hotknife (110V) #735100 \$139.95 EA

### A ENGEL R BLADE

Use to cut lengths of fabric, webbing and line. #18307 \$38.95 EA

### B HSO BLADE

Use for cutting sharp corners and precise detail work. #4325 \$37.95 EA

### C F BLADE

Use to make quick, straight cuts for webbing, rope, and narrow tapes and trim.  
#104097 \$25.95 EA

### D CUTTING FOOT

Attach to hotknife to eliminate the need for a sacrificial cutting surface.  
#100199 \$50.95 EA

### CARRYING CASE

Protect and store your hotknife and accessories in this durable plastic carrying case. #103798 \$10.95 EA



### WELLER® SOLDERING IRON & HOTKNIFE TIP

Handy soldering iron that can also act as a useful hotknife when used with optional tip. Built-in heat reserve maintains 900° F cutting temperature. Draws 40 watts. To reduce oxidation, remove the tip and steel wool the shaft every 24 hours of use.

Soldering Iron (120V) #18105 \$24.95 EA

Hotknife Tip #18102 \$13.95 EA



Exclusively from Sailrite

## SAILRITE® EDGE HOTKNIFE

Perfect, Sealed Edges Every Time!

Cut with precision and speed! Hot cutting blade cuts and seals the edges of rope, webbing, or synthetic fabrics and cords that would ravel when cut with scissors.

Trigger-operated and heats up in 4-6 seconds. Extra long 9.5 ft power cord. 60Hz/60W power. 1 year warranty.

Always cut on an insulated surface (ex. glass, mirror, or Formica) for cleaner cut or use with the included cutting foot.



◀ R BLADE

▼ F BLADE

SAILRITE EDGE HOTKNIFE PACKAGE INCLUDES:  
EDGE Hotknife body, R blade, cutting foot, plastic carrying case, wire brush, and hex key.

110V Package #103800 \$139.95 EA

220-240V (EU) Package #103799 \$139.95 EA

### Extras

Edge R Blade #103801 \$18.95 EA

F Blade #104097 \$25.95 EA

HSO Blade (p136) #4325 \$37.95 EA

Cutting Foot #103802 \$24.95 EA



# REPAIR KITS



## A Must-Have For Any Sailor!

### SAIL & CANVAS REPAIR KIT

Essential tapes and patch materials for sail, canvas (Sunbrella) and vinyl repairs with needles, twine, thread, and sail palm for hand sewing even thick assemblies. Includes waterproof floatable storage box for excellent weather protection.

**Kit Includes:** Waxed 5-ply twine bobbin (81 ft), V-69 & V-92 pre-wound bobbin thread, assorted hand needles (7 pack), William & Smith Sailmaker needles (5 pack), deluxe seam ripper, adjustable right-handed palm, 2" white adhesive-backed UV Dacron (15 ft), TEAR-AID® A (1 ft), TEAR-AID® B (1 ft), and large waterproof box (colors vary).

A #102571 \$84.45 KIT

### SMALL SAIL REPAIR KIT

Handy sail repair kit with right hand adjustable palm, wax, 1 oz. 5-ply twine, and 10 William & Smith Sailmaker needles in waterproof tube. Not available with left hand palm.

B #1376 \$65.95 KIT

### YACHTSMAN SAIL REPAIR KIT

Do your own sail repairs! Jim Grant's Sail Repair Manual is full of practical repair procedures and step-by-step instructions on sail patching, sail cleaning, size modifications, draft correcting and seaming flaws, as well as hand stitching techniques and instructions on home sewing machine use, repair, and timing adjustments.

**Kits Include:** Adjustable palm, thread, hand needles, seam ripper, sail twine, composition wax, System 130 needles, basting tape, sailmaker's leather, leech line, boltrope, jiffy grommets, sail tape, nylon material, and Sail Repair Manual (70 pp).

C Yachtsman Sail Repair Kit - Right Palm #34101A \$91.90 KIT

Yachtsman Sail Repair Kit - Left Palm #34102A \$91.90 KIT



# BASTING TAPE

Double-sided adhesive basting tapes (seamstick) make work with heavy fabrics easier and more accurate for amateurs and professionals alike! Use basting tape even for simple projects to help reduce needle pucker and make seams more water resistant.

## WHY USE BASTING TAPE?

- Accurate, even sewing
- Easier than pinning fabric
- Water resistant seams
- Reduce puckering
- Prevents feeding problems
- Invisible

Basting tape is a great way to get professional looking results on any size project!

## BASTING TAPE TIPS

- Basting tapes can leave a gum residue on the needle when sewing. To help prevent build-up, run the needle through a bar of Ivory soap or use a cotton swab with rubbing alcohol to keep the needle clean. Many professionals use a thread lubricant, like Sewers Aid (p.119), on a cloth pad clipped over the upper thread or a device like the Magnetic Oiler (p.119) to keep a consistent coating of lubricant on the top thread.
- When basting two panels of fabric together, make sure both the top and bottom fabric layers are stressed evenly all along the edge. Although the actual seam may not look bad if the lengthening was done gradually and evenly along the length of the fabric, the resulting seam is inadequate if one side is now longer than the other.



### ACRYLIC BASTING TAPE *Recommended for Sunbrella!*

Works well with coarse canvas products like Sunbrella or Top Gun. Can use with sailcloth but may lead to more gum on the needle. 50 yard roll.



WIDTH	PART #	1-24	25-143	144+
1/4"	#104167	\$6.95 EA	\$6.26 EA	\$5.56 EA
WIDTH	PART #	1-24	25-95	96+
3/8"	#129	\$9.95 EA	\$8.96 EA	\$7.96 EA
WIDTH	PART #	1-24	25-71	72+
1/2"	#104984	\$13.95 EA	\$12.56 EA	\$11.16 EA

### SEAMSTICK BASTING TAPE FOR SAILMAKING & VINYL

A double sided mylar film adhesive that bonds well on smooth Dacron sailcloth, nylon, vinyl, or cotton. Generally causes no problems with gum on the needle or skipped stitches. Choose a width similar to seam width. Narrow 1/4" width is used most often with home sewing fabrics. 50 yard roll.



WIDTH	PART #	1-24	25-143	144+
1/4"	#20306	\$3.95 EA	\$3.56 EA	\$3.16 EA
WIDTH	PART #	1-24	25-95	96+
3/8"	#659	\$5.95 EA	\$5.36 EA	\$5.36 EA
WIDTH	PART #	1-24	25-71	72+
1/2"	#20307	\$6.95 EA	\$6.26 EA	\$5.56 EA

### 3M SUPER SEAMSTICK BASTING TAPE

An incredibly sticky tape developed to eliminate sewing in laminates, Dacron, and ripstop nylon. Very aggressive but can slide apart in hot sunlight. Sewing is still recommended, especially in seams with horizontal stress (Intermittently clean the needle with rubbing alcohol on a cotton swab or an adhesive remover. Running your needle through a bar of Ivory soap can also prevent buildup). Waterproof and solvent resistant. 60 yard roll.



WIDTH	PART #	1-11	12+
1/2"	#1501	\$31.95 EA	\$28.76 EA
1"	#4516	\$53.95 EA	\$48.56 EA



### SEAMSTICK MYLAR / KEVLAR BASTING TAPE FOR LAMINATE SAILCLOTH

Specially designed to hold fabric laminates together and reinforce sewn seams. Cloth matrix allows stitches to hold better. 50 yard roll.

1/2" #4515 \$11.95 EA



# SUNBRELLA® ACRYLIC BINDING & FACING

Trim your Sunbrella fabric covers with matching Sunbrella Marine Grade binding. Lengthwise edges are turned under to minimize fraying and provide a clean finish. Sandwich over an edge and sew in place. Sailrite attempts to get bias cut binding whenever possible, however certain colors are only available in straight cut. Widths measured before installation. Use 2" Facing to trim around windows or reinforce edges for zippers and fasteners. One edge is folded over 1" to accommodate fastener installation and the other edge a 1/2". Sew flush to or folded over any edge.

Facing Underside

Binding Underside

## BINDING

COLOR	WIDTH	PART #	1-299	300+
NEW White	1"	#120831	\$0.50/FT	\$0.35/FT
	3/4"	#29135	\$0.40/FT	\$0.28/FT
Natural	1"	#11200	\$0.50/FT	\$0.35/FT
	1-1/4"	#120248	\$0.55/FT	\$0.39/FT
Parchment	1-1/4"	#120249	\$0.55/FT	\$0.39/FT
	3/4"	#102679	\$0.40/FT	\$0.28/FT
Oyster	1"	#409	\$0.50/FT	\$0.35/FT
	1-1/4"	#120250	\$0.55/FT	\$0.39/FT
Wheat	3/4"	#102920	\$0.40/FT	\$0.28/FT
	3/4"	#262	\$0.40/FT	\$0.28/FT
Linen	1"	#263	\$0.50/FT	\$0.35/FT
	1-1/4"	#120251	\$0.55/FT	\$0.39/FT
Toast	3/4"	#549	\$0.40/FT	\$0.28/FT
	1"	#102687	\$0.50/FT	\$0.35/FT
Heather Beige	1-1/4"	#120252	\$0.55/FT	\$0.39/FT
	3/4"	#103017	\$0.40/FT	\$0.28/FT
Beige	1"	#102681	\$0.50/FT	\$0.35/FT
	3/4"	#930011	\$0.40/FT	\$0.28/FT
Linen Tweed	1"	#259	\$0.50/FT	\$0.35/FT
	3/4"	#102604	\$0.40/FT	\$0.28/FT
Cocoa	1"	#102985	\$0.50/FT	\$0.35/FT
	1-1/4"	#120254	\$0.55/FT	\$0.39/FT
Taupe	1"	#103018	\$0.50/FT	\$0.35/FT
	3/4"	#102928	\$0.40/FT	\$0.28/FT
True Brown	1"	#102699	\$0.50/FT	\$0.35/FT
	3/4"	#103006	\$0.40/FT	\$0.28/FT
Silver	1"	#260	\$0.50/FT	\$0.35/FT
	3/4"	#200051	\$0.40/FT	\$0.28/FT
Cadet Grey	1-1/4"	#120246	\$0.55/FT	\$0.39/FT
	3/4"	#992	\$0.40/FT	\$0.28/FT
Charcoal Grey	1"	#261	\$0.50/FT	\$0.35/FT
	1-1/4"	#120247	\$0.55/FT	\$0.39/FT
Black	3/4"	#102607	\$0.40/FT	\$0.28/FT
	1-1/4"	#120245	\$0.55/FT	\$0.39/FT
Dubonnet Tweed	3/4"	#29138	\$0.40/FT	\$0.28/FT
	1"	#12400	\$0.50/FT	\$0.35/FT
	1-1/4"	#120244	\$0.55/FT	\$0.39/FT
	3/4"	#202	\$0.40/FT	\$0.28/FT

COLOR	WIDTH	PART #	1-299	300+
Jockey Red	3/4"	#339	\$0.45/FT	\$0.32/FT
	1"	#331	\$0.55/FT	\$0.39/FT
Burgundy	3/4"	#993	\$0.45/FT	\$0.32/FT
	1"	#330	\$0.55/FT	\$0.39/FT
Sunflower Yellow	1-1/4"	#120324	\$0.55/FT	\$0.39/FT
	1"	#460201	\$0.55/FT	\$0.39/FT
Forest Green	3/4"	#334	\$0.40/FT	\$0.28/FT
	1"	#329	\$0.50/FT	\$0.35/FT
Hemlock Tweed	1-1/4"	#120238	\$0.55/FT	\$0.39/FT
	3/4"	#26400	\$0.40/FT	\$0.28/FT
Spa	1"	#265	\$0.50/FT	\$0.35/FT
	3/4"	#102668	\$0.40/FT	\$0.28/FT
Aquamarine	3/4"	#102668	\$0.40/FT	\$0.28/FT
	1"	#120710	\$0.50/FT	\$0.35/FT
Persian Green	3/4"	#102606	\$0.40/FT	\$0.28/FT
	1"	#120954	\$0.50/FT	\$0.35/FT
Sky Blue	3/4"	#120514	\$0.50/FT	\$0.35/FT
	1"	#120514	\$0.50/FT	\$0.35/FT
Sapphire Blue	3/4"	#120330	\$0.50/FT	\$0.35/FT
	1"	#120330	\$0.50/FT	\$0.35/FT
Mediterranean Tweed	3/4"	#200053	\$0.40/FT	\$0.28/FT
	1"	#6875	\$0.40/FT	\$0.28/FT
Pacific Blue	3/4"	#411	\$0.50/FT	\$0.35/FT
	1"	#411	\$0.50/FT	\$0.35/FT
Ocean Blue	3/4"	#29136	\$0.40/FT	\$0.28/FT
	1-1/4"	#120239	\$0.55/FT	\$0.39/FT
Royal Blue Tweed	1"	#323	\$0.50/FT	\$0.35/FT
	3/4"	#102685	\$0.40/FT	\$0.28/FT
Marine Blue	1"	#121164	\$0.50/FT	\$0.35/FT
	3/4"	#95001	\$0.40/FT	\$0.28/FT
Navy	1"	#269	\$0.50/FT	\$0.35/FT
	3/4"	#102494	\$0.40/FT	\$0.28/FT
Captain Navy	1-1/4"	#120240	\$0.55/FT	\$0.39/FT
	3/4"	#102494	\$0.40/FT	\$0.28/FT
	1"	#103593	\$0.50/FT	\$0.35/FT
	3/4"	#120241	\$0.55/FT	\$0.39/FT
	1"	#120241	\$0.55/FT	\$0.39/FT
	3/4"	#29137	\$0.40/FT	\$0.28/FT
	1"	#327100	\$0.50/FT	\$0.35/FT
	3/4"	#102494	\$0.40/FT	\$0.28/FT
	1-1/4"	#120242	\$0.55/FT	\$0.39/FT
	3/4"	#566	\$0.40/FT	\$0.28/FT
	1"	#541422	\$0.50/FT	\$0.35/FT
	1-1/4"	#120243	\$0.55/FT	\$0.39/FT

WHITE	NATURAL	PARCHMENT
OYSTER	WHEAT	LINEN
TOAST	HEATHER BEIGE	BEIGE
LINEN TWEED	COCOA	TAUPE
TRUE BROWN	SILVER	CADET GREY
CHARCOAL GREY	BLACK	DUBONNET TWEED
JOCKEY RED	BURGUNDY	SUNFLOWER YELLOW
FOREST GREEN	HEMLOCK TWEED	SPA
AQUAMARINE	PERSIAN GREEN	SKY BLUE
SAPPHIRE BLUE	MEDIT. TWEED	MEDIT. BLUE
PACIFIC BLUE	OCEAN BLUE	ROYAL BLUE TWEED
MARINE BLUE	NAVY	CAPTAIN NAVY

## SUNBRELLA® ACRYLIC BRAID SOFT BINDING

European style 100% solution-dyed acrylic braid. Ideal for work around curves on awnings and boat tops. Lays flat when sewn to an edge. Not as durable as acrylic or centerfold binding but much more flexible. Width: 13/16" (before installation).

1-299 feet: \$0.25/FT | 300+ feet: \$0.16/FT

NATURAL	OYSTER	LINEN	CADET GREY	TOAST	BURGUNDY
#120604	#120612	#120610	#120608	#120607	#120609
NAVY	CAPTAIN NAVY	PACIFIC BLUE	FOREST GREEN	BLACK	
#120606	#120613	#120603	#120611	#120605	

## SUNBRELLA 7/8" CENTERFOLD ACRYLIC BINDING

Woven from Sunbrella acrylic yarns to match Sunbrella fabric perfectly! Lengthwise edges are woven to minimize fraying. Folds naturally in the center for easy installation. Works well around corners. Easy to sew even without a binder attachment. Width: 7/8" (before installation).

1-599 feet: \$0.20/FT | 600+ feet: \$0.14/FT

WHITE	CADET GREY	BEIGE	FOREST GREEN	BURGUNDY	PACIFIC BLUE
#503914	#503912	#503920	#503919	#503916	#503911
NAVY	BLACK				
#503913	#503915				



### HEAVY DUTY BINDER ATTACHMENTS p.123

Quickly and easily install binding tapes to the edges of enclosures, awnings, dodgers, biminis, and bags. Binder attachments automatically guide and fold tape into place over the edge of fabric.



### ORDER BY THE ROLL FOR A QUANTITY DISCOUNT.

Lowest price shown reflects full roll discount.

## FACING

COLOR	WIDTH	PART #	1-299	300+
Natural	2"	#102495	\$0.90/FT	\$0.77/FT
Linen	2"	#102471	\$0.90/FT	\$0.77/FT
Cadet Grey	2"	#102469	\$0.90/FT	\$0.77/FT
Black	2"	#102467	\$0.90/FT	\$0.77/FT
Burgundy	2"	#102470	\$1.05/FT	\$0.89/FT

COLOR	WIDTH	PART #	1-299	300+
Forest Green	2"	#102472	\$0.90/FT	\$0.77/FT
Pacific Blue	2"	#102466	\$0.90/FT	\$0.77/FT
Navy	2"	#102468	\$0.90/FT	\$0.77/FT
Captain Navy	2"	#102473	\$0.90/FT	\$0.77/FT



## STAMOID BINDING & FACING

Features Stamoid vinyl fabric (p.24). Use binding to trim dodger, bimini, awning, and other cover edges. Sandwich fabric edge and sew in place. Use facing to trim and reinforce edges around windows and zippers. Sew flush to or folded over the edge. Binding edges are turned under 1/4" on both sides. Facing has one lengthwise edge turned under 1" to accommodate fastener installation and the other a 1/2" for a clean appearance. Widths measured before installation.

**A** 3/4" Binding 1-299 Feet **\$0.40/FT** | 300+ Feet **\$0.32/FT**

**B** 1" Binding 1-299 Feet **\$0.45/FT** | 300+ Feet **\$0.36/FT**

**C** 2" Facing 1-149 Feet **\$0.95/FT** | 150+ Feet **\$0.76/FT**



		
A #12921 B #106703 C #129212	A #11304 B #106702 C #113042	A #12515 B #106705 C #125152
		
A #11747 B #106706 C #117472	A #12249	A #11400
		
A #11534	A #12592 B 106707	A #11891 B #106704 C #118912

## WEBLON BINDING

Bias cut binding tape made from Weblon Regatta vinyl fabric (p.23). Use to trim dodger, bimini, awning, and other cover edges as well as zipper flaps. Lengthwise edges have been turned under about 1/4" to provide a clean finished look when installed. Sandwich a fabric edge and sew in place.

**A** Width: 3/4" (before installation) 1-149 Feet **\$0.40/FT** | 150+ Feet **\$0.32/FT**

**B** Width: 1" (before installation) 1-149 Feet **\$0.45/FT** | 150+ Feet **\$0.36/FT**

		
A #103636 B #106699	A #103637 B #106700	A #103639 B #106701

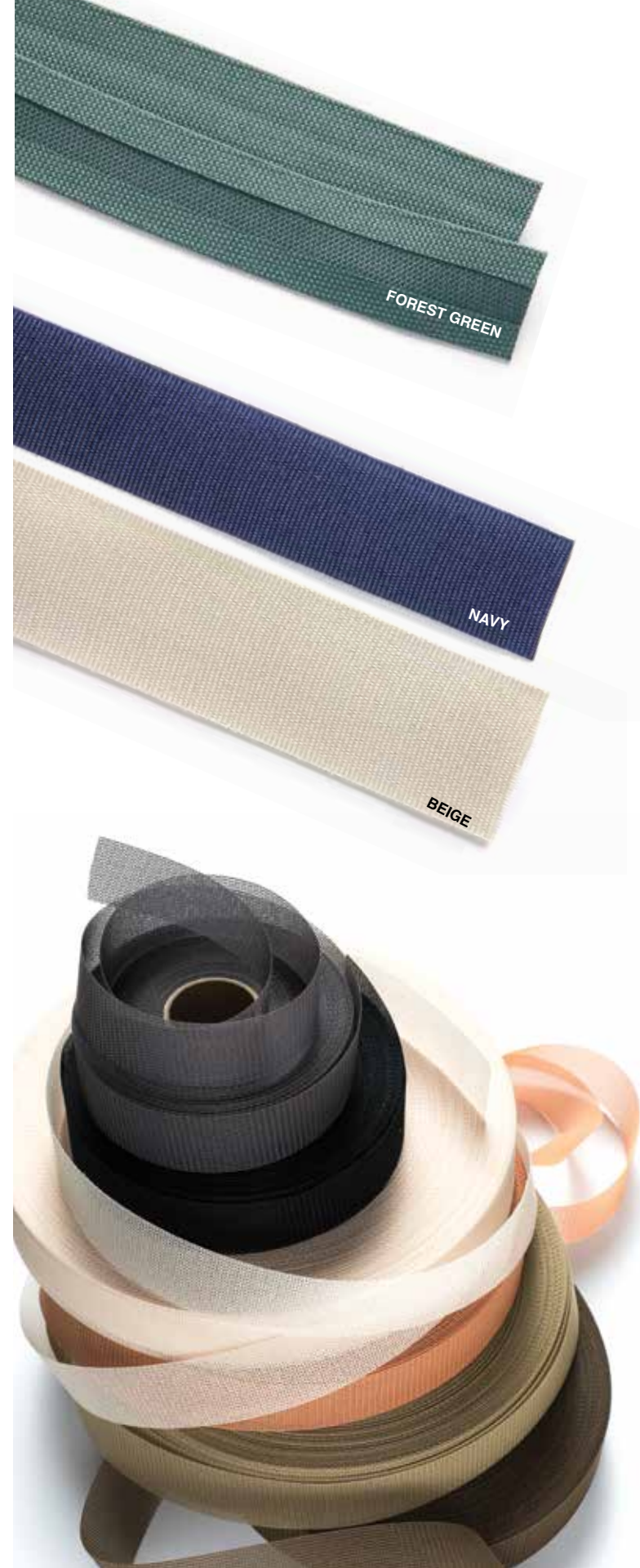

## SUR LAST 3/4" BINDING

Made from lightweight, strong, and flexible Sur Last (p.29). Use to provide a finished, attractive appearance to fabric edges. Sandwich a fabric edge and sew in place on canopies, dodgers, biminis, and more. Width: 3/4" (before installation).

1-299 Feet **\$0.40/FT** | 300+ Feet **\$0.32/FT**

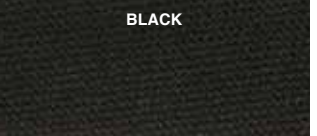
	
#102544	#102541

## BINDING TAPE POLYESTER

Durable binding trim that is perfect for trimming raw edges on bags, pouches, backpacks, apparel, carpets, and more. This binding is made from polyester, which offers better resistance to UV rays than nylon binding. Also works well as a backing or reinforcement tape. Works with Sailrite's straight binders.

**A** 3/4" Binding 1-299 Feet **\$0.15/FT** | 300+ Feet **\$0.12/FT**

**B** 1" Binding 1-299 Feet **\$0.20/FT** | 300+ Feet **\$0.16/FT**

	
A #105512 B #105420	A #105515 B #105423
	
A #105513 B #105421	A #105514 B #105422

## 1-1/4" POLYESTER CARPET BINDING

Durable, lightweight binding trim that gives carpets and mats a clean, finished look. Made from pre-dyed polyester, this binding has great UV resistance. Perfect for trimming raw edges on carpets, rugs, snap-in mats, bags and more. Sandwich over fabric edge and sew in place.

1-431 Feet **\$0.15/FT** | 432+ Feet **\$0.12/FT**

			
#120236	#120232	#120229	#120237
			
#120230	#120231	#120235	#120234

**POLYESTER CARPET BINDING IS IDEAL FOR USE WITH CHILEWICH & INFINITY LUXURY WOVEN VINYL! (P.78-79)**



## NEW TOP NOTCH 9 POLYESTER 1" BIAS BINDING

Made from durable, solution-dyed Top Notch 9 fabric (p. 21). Cut on the bias to allow the binding to take curves better than straight cut bindings. Lengthwise edges are folded under to provide a clean, finished edge. Use to create a finished edge on biminis, dodgers, awnings and more. Install by sandwiching the binding over the raw edge of your fabric and sew in place. Width: 1" (before installation)

1-299 Feet **\$0.50/FT** | 300+ Feet **\$0.38/FT**

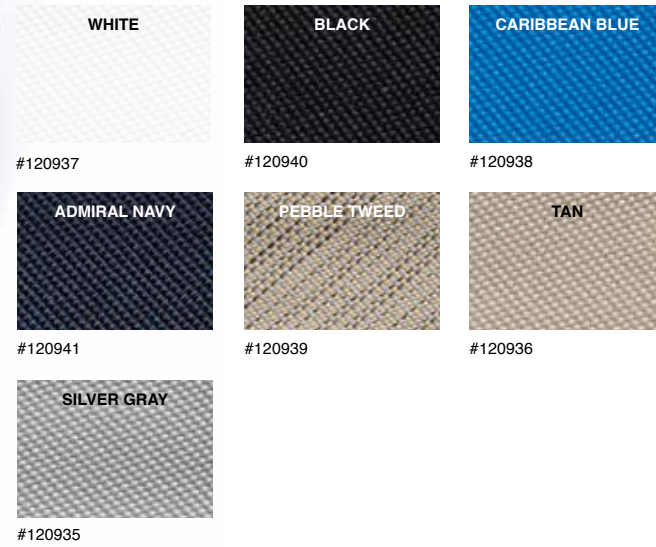

## NEW FELT POLYESTER 1-1/4" BINDING

This non-woven, felt binding tape lays flat around corners for a wrinkle free look. Classic, felted texture and solution-dyed color that won't fade in the sun. This binding tape is UV stable and has high heat resistance and is resistant to mold, mildew, stains and chemicals. Use for snap-in marine mats and boat carpeting as well as automotive applications. Not recommended for marine canvaswork. Width: 1-1/4" (before installation)

1-149 Feet **\$0.25/FT** | 150+ Feet **\$0.23/FT**



### ANTI-WICK NYLON TAPE

Durable, military style binding tape. Features a plain weave construction and an anti-wick coating to ensure long life in the sun and to keep water out of stitch holes. Great for trimming raw edges of bags, pouches and other canvas items, or as a backing or reinforcement tape. Works with 1" Straight Binder (p.123). Width: 1". Black.

#104220

1-299 Feet **\$0.20/FT**  
300+ Feet **\$0.18/FT**



### BINDING TAPE MAKER

Make your own binding tape. Cut fabric into strips (1-3/4" for 1" binding and 3-7/8" for 2") and pass through tape maker. Press when necessary (cold or very low temperature iron on synthetics).

1" Tape Maker **#406123 \$7.95 EA**  
2" Tape Maker **#100184 \$13.95 EA**



### SNAP-ON WINDLACE

Flexible, double lip plastic windlace for interior or exterior use on boats, cars, and RVs. Cover raw fiberglass or metal edges (1/16" thick or less). Easy snap-on installation. Metal core and leather grain surface. Cut with wire cutters. Black.

#100296

1-99 Feet **\$0.95/FT**  
100+ Feet **\$0.86/FT**

## MORBERN SEABROOK HIDEM GIMP

Most commonly used to cover stapled seams. Fold back from middle, place over unfinished edges, and staple or tack under folds to secure. Folds will conceal staples or tacks for finished appearance. Made from premium Seabrook marine grade vinyl from Morbern and perfectly matches all Seabrook Vinyls, Headliners and Channeling Fabrics. Width: 3/4"

1-74 Feet **\$0.55/FT** | 75+ Feet **\$0.47/FT**



## SUNBRELLA® DECORATIVE PIPING & TRIM

Add the finishing touches to your cushion and pillow projects! Twisted cord piping made with polypropylene cord (filler yarns) wrapped with Sunbrella solution-dyed acrylic yarns. Perfect for trimming indoor and outdoor cushions, pillows, patio furniture, patio umbrellas, and ottomans. Pair with Sunbrella Upholstery Fabrics.

Sews easily with a 1/4" Cording Foot on the Sailrite Fabricator or a Roping Zipper Foot on the Sailrite Ultrafeed. Cord Diameter: 1/4". Tape Width: 1/2" (without cord). Maximum continuous length is 75 feet.



## SUNBRELLA® DECORATIVE FRINGE

Beautiful, long-lasting fringe trim for outdoor and indoor pillows, cushions, patio umbrellas, and ottomans. Made from Sunbrella 100% solution-dyed acrylic yarns for excellent fade and weather resistance as well as mold and mildew resistance. Pair with Sunbrella Upholstery Fabrics. Sew or tack in place. Width: 2". Maximum continuous length is 75 feet.

**\$3.00/FT**

### SOLID TRIM COLORS 1-74 Feet \$1.45/FT | 75+ Feet \$1.31/FT



### MIXED TRIM COLORS 1-74 Feet \$1.45/FT | 75+ Feet \$1.31/FT

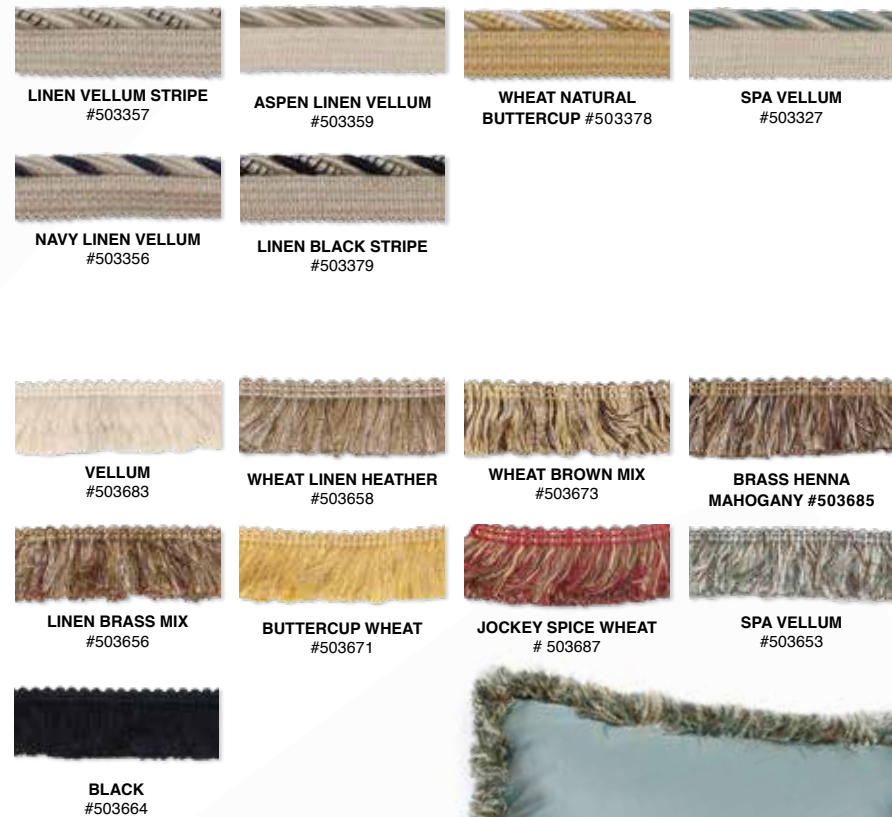

## MORBERN SEABROOK VINYL WELTING/PIPING

Add a professional edge to your vinyl upholstery with piping. This flexible piping is made from Seabrook Marine Vinyl to be a perfect color-match to all Seabrook vinyl, headliner and channeling fabric but it also looks great with other vinyl, Phifertex and Sunbrella fabrics. Easy to install and designed for marine use.

**Lip Width: 7/16" Piping Width: 1/4" Overall Width: 11/16"**

1-149 Feet **\$0.60/FT** | 150+ Feet **\$0.54/FT**

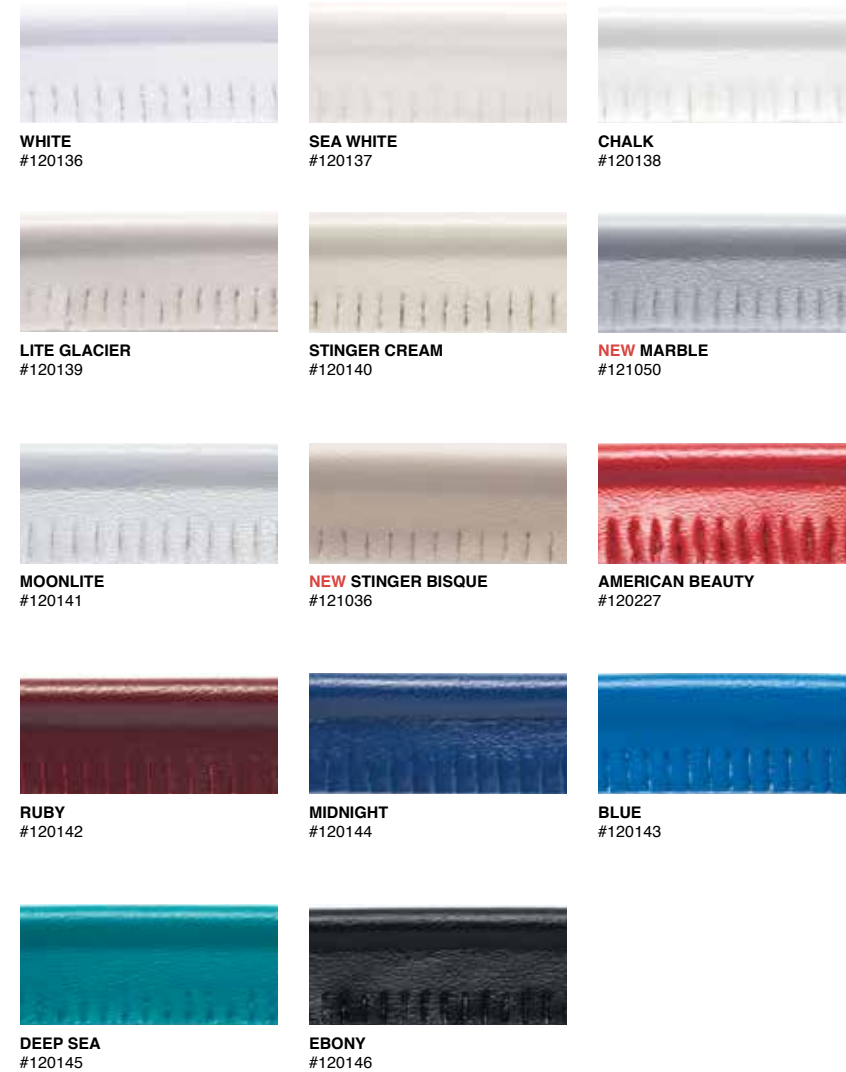

### PIPING CORD

Foam 5/32" piping cord used to make custom piping. Mildew and rot resistant. Great for outdoor and marine applications. 10 foot minimum.

**#1055 \$0.10/FT**

See our step-by-step instructions "How to Join Piping Ends" at Sailrite.com (#X-HT-300038)

## NAUGAHYDE UNIVERSAL VINYL WELTING/PIPING

Dress up exterior and interior cushions! Soft, flexible welting made from high quality Naugahyde Universal vinyl and soft 5/32" foam cord. Easy to sew and install. Perfect match to Naugahyde Universal colors. Also looks great with Phifertex or Sunbrella fabric. Designed for marine use. Easy to clean.

**Lip Width: 1/4"**

**Piping Width: 7/32"**

**Overall Width: 15/32"**

1-149 Feet **\$0.65/FT**

150+ Feet **\$0.55/FT**



# WEBBING

## POLYESTER WEBBING

Strong, rugged, and UV resistant webbing made for outdoor use. Use for sail corners, hiking straps, bag handles, tie downs, reinforcements, trampolines, and nose pieces on kites. More colors available at [Sailrite.com](http://Sailrite.com)



WIDTH	COLOR	AVG. STRENGTH	PART #	1-326	327+
2"	Beige	4,720 lb.	#120263	\$1.10/FT	\$0.66/FT
2"	Forest Green	4,720 lb.	#120265	\$1.10/FT	\$0.66/FT
2"	Navy	4,720 lb.	#120266	\$1.10/FT	\$0.66/FT
2"	Royal Blue	4,720 lb.	#120262	\$1.10/FT	\$0.66/FT
2"	White	4,720 lb.	#120264	\$1.10/FT	\$0.66/FT

\*9 panel construction

WIDTH	COLOR	AVG. STRENGTH	PART #	1-299	300+
1"	White	1,500 lb.	#531600	\$0.30/FT	\$0.18/FT
1"	Black	1,500 lb.	#103416	\$0.30/FT	\$0.18/FT
2"	Black	5,500 lb.	#100437	\$0.65/FT	\$0.39/FT

\*\*5 panel construction (seat belt webbing)

## NYLON WEBBING

Excellent strength without the bulk! Use as straps, at sail corners for ring installation, or along a canvas edge for fastener reinforcement.

WIDTH	COLOR	AVG. STRENGTH	PART #	1-299	300+
1/2"	White	550 lb.	#22301	\$0.25/FT	\$0.15/FT
3/4"	White	700 lb.	#22302	\$0.25/FT	\$0.15/FT
1"	White	1,100 lb.	#22303	\$0.35/FT	\$0.21/FT
1"	Black	900 lb.	#17300	\$0.35/FT	\$0.21/FT
1-1/2"	White	900 lb.	#22305	\$0.65/FT	\$0.39/FT
1-1/2"	Black	1,600 lb.	#100258	\$0.60/FT	\$0.36/FT
2"	White	3,000 lb.	#22304	\$0.90/FT	\$0.54/FT
2"	Black	1,800 lb.	#806	\$0.70/FT	\$0.42/FT

\*\*5 panel construction

## SUNBRELLA WEBBING

A perfect match to Sunbrella fabrics! This webbing is a blend of polyester and acrylic that is resistant to fading, perfect for applications that will be exposed to sunlight. Use this webbing for utility work, bag handles, sail ties, frame straps, and more.



WIDTH	COLOR	AVG. STRENGTH	PART #	1-74	75+
1"	Pacific Blue	1,000 lb.	#144401	\$0.95/FT	\$0.76/FT
1"	Natural	1,000 lb.	#144404	\$0.95/FT	\$0.76/FT
1"	Black	1,000 lb.	#144408	\$0.95/FT	\$0.76/FT
1"	Cadet Gray	1,000 lb.	#144430	\$0.95/FT	\$0.76/FT
1"	Burgundy	1,000 lb.	#144431	\$0.95/FT	\$0.76/FT

## TUBULAR WEBBING

Thick, bulky construction with hollow center. Great for sail corners, jacklines, bag handles, and hiking straps. Available in nylon or polyester.

Tubular construction adds strength and durability. ▶

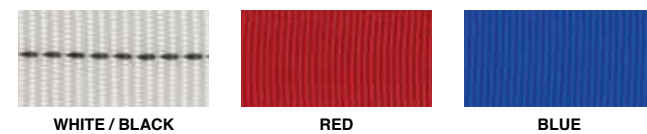

WIDTH	TYPE	COLOR	AVG. STRENGTH	PART #	1-149	150+
1/2"	Poly	White/Bl.	1,550 lb.	#531590	\$0.25/FT	\$0.15/FT

WIDTH	TYPE	COLOR	AVG. STRENGTH	PART #	1-299	300+
3/4"	Poly	White/Bl.	2,295 lb.	#531610	\$0.30/FT	\$0.18/FT
1"	Poly	White/Bl.	2,700 lb.	#82300	\$0.45/FT	\$0.27/FT
1"	Nylon	Red	2,400 lb.	#4570	\$0.90/FT	\$0.54/FT
2"	Nylon	Blue	2,595 lb.	#4571	\$1.10/FT	\$0.66/FT
2"	Nylon	Red	2,595 lb.	#4572	\$1.15/FT	\$0.69/FT

## POLYPROPYLENE WEBBING

Ideal for utility work, bag handles, and sail ties. Use polyester webbing for better UV resistance.



WIDTH	COLOR	AVG. STRENGTH	PART #	1-299	300+
1"	Black	360 lb.	#100080	\$0.15/FT	\$0.09/FT
1"	Gray	360 lb.	#100933	\$0.15/FT	\$0.09/FT
1"	White	360 lb.	#22306	\$0.15/FT	\$0.09/FT
1"	Off White	360 lb.	#100932	\$0.15/FT	\$0.09/FT
1"	Linen	360 lb.	#100937	\$0.15/FT	\$0.09/FT
1"	Tan	360 lb.	#100934	\$0.15/FT	\$0.09/FT
1"	Brown	360 lb.	#100081	\$0.15/FT	\$0.09/FT
1"	Yellow	360 lb.	#100935	\$0.15/FT	\$0.09/FT
1"	Red	360 lb.	#100085	\$0.15/FT	\$0.09/FT
1"	Burgundy	360 lb.	#100931	\$0.15/FT	\$0.09/FT
1"	Concord	360 lb.	#100938	\$0.15/FT	\$0.09/FT
1"	Royal Blue	360 lb.	#100936	\$0.15/FT	\$0.09/FT
1"	Navy	360 lb.	#100084	\$0.15/FT	\$0.09/FT
1"	Forest Gr.	360 lb.	#100929	\$0.15/FT	\$0.09/FT
2"	Black	800 lb.	#204420	\$0.25/FT	\$0.15/FT
2"	White	1,200 lb.	#22308	\$0.30/FT	\$0.18/FT
2"	NEW White	800 lb.	#121151	\$0.25/FT	\$0.15/FT
3"	Black	1,800 lb.	#264290	\$0.45/FT	\$0.27/FT

## EXTRA HEAVY WEIGHT NYLON WEBBING

Perfect for safety straps, tethers, and jacklines or where maximum safety is required. Meets ORC strength requirements.

WIDTH	COLOR	AVG. STRENGTH	PART #	1-149	150+
1"	White	4,700 lb.	#1271	\$0.85/FT	\$0.51/FT
1"	Blue	5,300 lb.	#4532	\$1.10/FT	\$0.66/FT

## MEDIUM WEIGHT NYLON WEBBING

Strong enough for webbing straps yet thin enough to fit metal and plastic buckles. Used in Sailrite Webbing Strap Kits.

WIDTH	COLOR	AVG. STRENGTH	PART #	1-299	300+
1"	White	2,200 lb.	#102226	\$0.55/FT	\$0.33/FT

## DYNEEMA WEBBING

Long lasting, superior strength without bulk. Dyneema features superior UV resistance & maintains its strength longer in the elements than other webbing. Perfect for support straps, sail corners, and edge reinforcement.

WIDTH	COLOR	AVG. STRENGTH	PART #	1-164	165+
1"	White	3,500 lb.	#106406	\$2.20/FT	\$1.98/FT
2"	White	6,400 lb.	#106407	\$3.95/FT	\$3.56/FT

## SPECTRA® WEBBING

Strong but lighter than Kevlar with low stretch fiber and excellent UV resistance and flex characteristics. Use in webbing assemblies on laminates and other large sails.

WIDTH	COLOR	AVG. STRENGTH	PART #	PRICE
1-3/4"	White	7,000 lb.	#22309	\$5.60/FT



- Use E-Z Lace Supreme to attach sandbags to Winter Boat Covers.



## E-Z LACE SUPREME

A convenient thin fabric strip with reinforced lacing holes designed to secure awnings, tents, canopies, boat covers, wind barriers, and privacy shields without grommets. Lacing holes are 25% stronger than traditional grommets and reinforced with Armor Bar™, a high-tenacity polyester yarn, for increased tear resistance and strength. UV and mildew resistant. Sew in place. Lacing holes: 1 inch wide spaced every 3 inches. Width: 2-1/8". 42% solution dyed acrylic, 58% solution dyed polyester.

1-149 \$1.05/FT | 150+ \$0.79/FT



#103695



#103699



#103697



#103700



#103690



#103696



#103698



▲ Kit shown assembled



▲ Kit components

### New & Improved!

#### WEBBING STRAP KIT

Adjust the tension on boat tops and covers with a single pull. Try one and you'll want to replace all of your straps! Finished strap can adjust between 2-6 ft.

Kit Includes: 1" Sunbrella Webbing Natural, webbing slider, loop loc, snap hook, thread, and instructions.

#121359 \$22.30 KIT



Pacific Blue  
#107166

### Designed to Last

#### SAIL TIE KIT

Very handy! Secure with a simple slip knot around a doused sail. Kit includes: 30 ft Sunbrella webbing, hembobs, and instructions. Color options below.

Kit constructs ONE of the following:

- 3 - 9' Sail ties (boats > 50 feet)
- 5 - 5' Sail ties (boats 30-50 feet)
- 6 - 4' Sail ties (boats < 30 feet)

\$33.45 EA



PACIFIC BLUE  
#107166



NATURAL  
#107165



BLACK  
#107162

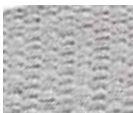

CADET GRAY  
#107169



BURGUNDY  
#107167

## MARINE HOOK & LOOP

Traditional hook and loop. Very strong shear and parting strength. Peel apart to separate. Open and close repeatedly without affecting strength. Unlimited adjustability. Polyester holds up best in sunlight. Secure to hard surfaces with Velcro® Cement or acrylic glue sticks. Sew around the edges to attach to fabric. Hook side is rough and scratchy while the Loop side is soft and fuzzy. Hook and loop sold separately.

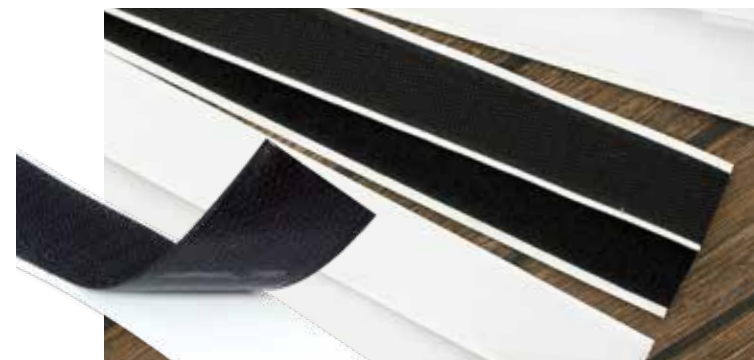
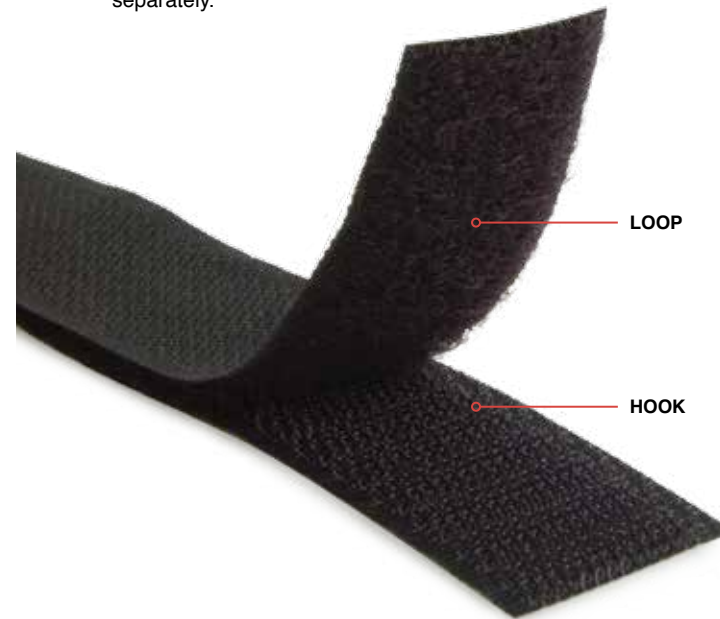

#### ADHESIVE BACKED NYLON HOOK & LOOP

High temperature acrylic pressure-sensitive adhesive-backed hook and loop. Use in applications where high bond strength is necessary. Hook and loop sold separately.

WIDTH	COLOR	PART #	1-149	150+
<b>HOOK</b>				
1"	White	#102219	\$0.40/FT	\$0.36/FT
1"	Black	#102490	\$0.40/FT	\$0.36/FT
2"	White	#102221	\$0.75/FT	\$0.60/FT
<b>LOOP</b>				
1"	White	#102220	\$0.40/FT	\$0.36/FT
1"	Black	#102491	\$0.40/FT	\$0.36/FT
2"	White	#102222	\$0.75/FT	\$0.60/FT

<b>LOOP</b>					
WIDTH	MATERIAL	COLOR	PART #	1-149	150+
5/8"	Nylon	White	#465100	\$0.15/FT	\$0.12/FT
5/8"	Nylon	Black	#466100	\$0.15/FT	\$0.12/FT
1"	Nylon	White	#471100	\$0.20/FT	\$0.16/FT
1"	Nylon	Black	#472100	\$0.20/FT	\$0.16/FT
1"	Polyester	White	#478100	\$0.15/FT	\$0.12/FT
1"	Polyester	Black	#105036	\$0.15/FT	\$0.12/FT
1-1/2"	Nylon	Black	#103407	\$0.30/FT	\$0.24/FT
2"	Nylon	White	#100515	\$0.40/FT	\$0.32/FT
2"	Nylon	Black	#100256	\$0.40/FT	\$0.32/FT
2"	Polyester	White	#105033	\$0.55/FT	\$0.44/FT
2"	Polyester	Black	#105031	\$0.55/FT	\$0.44/FT

<b>HOOK</b>					
WIDTH	MATERIAL	COLOR	PART #	1-149	150+
5/8"	Nylon	White	#463100	\$0.15/FT	\$0.12/FT
5/8"	Nylon	Black	#464100	\$0.15/FT	\$0.12/FT
1"	Nylon	White	#467100	\$0.20/FT	\$0.16/FT
1"	Nylon	Black	#469100	\$0.20/FT	\$0.16/FT
1"	Polyester	White	#473100	\$0.15/FT	\$0.12/FT
1"	Polyester	Black	#105035	\$0.15/FT	\$0.12/FT
1-1/2"	Nylon	Black	#103405	\$0.30/FT	\$0.24/FT
2"	Nylon	White	#100514	\$0.40/FT	\$0.32/FT
2"	Nylon	Black	#100255	\$0.40/FT	\$0.32/FT
2"	Polyester	White	#105034	\$0.55/FT	\$0.44/FT
2"	Polyester	Black	#105032	\$0.55/FT	\$0.44/FT



#### NEW SURFACE MOUNT DISK HOOK 1-1/8"

Hard plastic disc with the hook side of hook and loop fastener on the front. A 1/8-inch screw hole in the center allows for easy installation to hard surfaces. Hook connects to any standard loop tape. Perfect for use in RVs or boats to hold shades or blind in place when down or in place of curtain tiebacks. Diameter: 1-1/8"

A #120929 \$5.95 PK10

#### VELCRO® CEMENT

Secure Velcro tapes or circles to hard surfaces or fabric prior to sewing. Works well on most marine applications. Secures about 15 ft. of 1" wide tape per tube. 1 oz. tube.

B #25303 \$2.95 EA

# TRIM & REPAIR TAPES

## ADHESIVE-BACKED TAPES

3 oz.



3/4 oz.



### ADHESIVE-BACKED REPAIR TAPE

Excellent emergency repair system. Pressure-sensitive adhesive-backed tapes. Simply cut, peel, and stick. Use Dacron tape for repairs on Dacron sailcloth and ripstop nylon tape on ripstop fabrics like spinnaker sails, flags, kites, and light awnings. Width: 2".

**3 oz. Dacron (15 ft. roll)**

White #2353 \$4.95 EA

**3/4 oz. Ripstop Nylon (25 ft. roll)**

White #100089 \$7.95 EA

Black #100086 \$7.95 EA

Blue #100087 \$7.95 EA

Yellow #100090 \$7.95 EA

Red #100088 \$7.95 EA

### ADHESIVE-BACKED UV DACRON

Great for general sail repair, UV sun covers on headsails, spreader patches, and boltrope sleeve repair. Peel off paper backing and stick in place (sew for permanent attachment). White, 4.19 oz. Sold per running yard.

10" Width #721 \$5.95 YD

14" Width #722 \$7.95 YD

18" Width #1348 \$9.95 YD

### LAMINATE REPAIR TAPE

Repair laminate racing sails. Pressure-sensitive adhesive-backed 3 mil polyester scrim blends in with today's most popular laminate sailcloths. Holds extremely well without sewing. Simply cut, peel, and stick. Translucent film with white and black scrim. 3" wide. 10 yard roll.

#104990 \$27.95 EA



### TEAR AID® FABRIC REPAIR PATCHES

Repair holes and tears in awnings, boat and RV covers, umbrellas, wetsuits, vinyl windows, tents, mosquito screens, backpacks, bags, tarps, nylon sails, and parkas. Clear, adhesive-backed patches available in handy repair kits or sold by the foot on a 3" wide roll (includes application instructions).

#### Kits Include:

- 1 - 3" x 12" patch
- 1 - 7/8" x 7/8" patch
- 1 - 1-3/8" x 1-3/8" patch
- 12" reinforcement filament for repairing tears along edges
- Alcohol prep pads

#### Type A:

Canvas (Sunbrella), most fabrics & plastics, nylon, rubber, neoprene, fiberglass, stainless steel, aluminum, polyethylene, polypropylene, polyurethane, and non-oiled leather.

Type A Kit #83211 \$10.25 KIT

Type A 3" Tape #83244 \$4.95/FT

#### Type B:

Vinyl or vinyl-coated products. Tear-Aid B resists the oils in vinyl that cause other adhesives to fail.

Type B Kit #83411 \$10.25 KIT

Type B 3" Tape #83466 \$4.95/FT

### DRAFT TAPE

Adhesive-backed 1" Dacron strips. Apply in horizontal bands across sail to help identify sail shape changes.

1-149 Feet \$0.25/FT | 150+ Feet \$0.20/FT

Red #100069

Blue #100066

Black #100065



## NON-ADHESIVE TAPES



### 4 OZ. DACRON TAPE

Use for lightweight edge finishing on large spinnakers. Width: 2".

1-299 Feet \$0.30/FT

300+ Feet \$0.27/FT

Green #104807

White #104809

Red #104808

### SHELTER-RITE TAPE

Excellent for chafe protection or reinforcing edges of covers, trampolines or tarps. 18 oz. Shelter-Rite material. Width: 3".

White #104223 \$0.99/FT

Black #104222 \$0.99/FT



### RIGGING TAPE (SELF-BONDING)

Protect your sails from chafe and sharp protrusions. Wrap around turnbuckles, cotter pins, or objects that can harm sails, running rigging, or people. Waterproof. UV resistant. Will not ravel. Bonds to itself to make one solid piece. Width: 1". 10 foot roll.

White #100968 \$7.95 EA

Black #100969 \$7.95 EA

### NYLON TAPE / RIBBON

Lightweight strapping tape for drogues, parachute anchors, and sail ties. Black. Width: 3/4".

#2012

1-299 Feet \$0.25/FT

300+ Feet \$0.23/FT



## LUFF REINFORCEMENT

### A CONTINUOUS SUPPORT TAPE

Most frequently used in roller furling rigs along the leading edge of the sail. Use instead of jib snaps. Sew in place (no stretching necessary) and slide into a Headfoil, Streamstay, Reefer, Twin Stay, Sea Furl, Gemini, Tuff Luff or similar grooved extrusion fitting over the headstay.

Two hard braided cords sewn into a narrow strip of cloth. Size and spacing of cords is very important and the second 1/8" backup cord is designed to keep the sail from jamming.

Refer to your furling system manual or call the manufacturer for appropriate tape size. Finished 6.5 oz. Dacron tape. Width: 5" (both lines installed). Size #6 is most popular.

#4 (1/8" dia.) #22101\* \$2.20/FT

#5 (5/32" dia.) #22102 \$2.10/FT

#6 (3/16" dia.) #22103 \$2.25/FT

#7 (7/32" dia.) #22104\* \$2.65/FT

#8 (1/4" dia.) #22105\* \$2.90/FT

\*Special Order Item (4-5 extra ship days)

10 ft. minimum. Not returnable.

### B PREFABRICATED MAINSAIL BOLTROPE / LUFF TAPE

Position and tension along the sail's luff and sew in place as reinforcement. Stretches more than sailcloth but can be used to gather the sail edge in light air and ultimately increase sail draft. Also helps distribute localized stress in grommets or jib snaps along the edge. 8 oz. Dacron 4" tape folded around a 5/16" 3-strand soft spun polyester rope.

#100379 \$2.90/FT

### C UV DACRON SAIL TAPE

Use along the edge of a sacrificial cover on the leech and foot of a sail to easily finish raw edges. Very little stretch. White.

2" #102566 1-299 Feet \$0.55/FT | 300+ Feet \$0.50/FT

3" #998 1-299 Feet \$1.00/FT | 300+ Feet \$0.90/FT

### DACRON SAIL TAPE

Finish the edges of sails, reinforce fastener locations, and form sleeves for drawing boltrope. Long strips of Dacron cloth cut with the grain for very little stretch. Apply multiple layers to add strength or replace boltropes. White.

WIDTH	WEIGHT	PART #	1-299	300+
2"	5oz	#22118	\$0.40/FT	\$0.36/FT
3"	5oz	#22108	\$0.55/FT	\$0.50/FT
3"	8oz	#104471	\$0.75/FT	\$0.68/FT
4"	5oz	#22109	\$0.75/FT	\$0.68/FT
4"	8oz	#104472	\$0.90/FT	\$0.81/FT
5"	8oz	#101024	\$1.25/FT	\$1.13/FT
6"	5oz	#22110	\$0.95/FT	\$0.86/FT

### D FLAT

WIDTH	WEIGHT	PART #	1-299	300+
2"	5oz	#22118	\$0.40/FT	\$0.36/FT
3"	5oz	#22108	\$0.55/FT	\$0.50/FT
3"	8oz	#104471	\$0.75/FT	\$0.68/FT
4"	5oz	#22109	\$0.75/FT	\$0.68/FT
4"	8oz	#104472	\$0.90/FT	\$0.81/FT
5"	8oz	#101024	\$1.25/FT	\$1.13/FT
6"	5oz	#22110	\$0.95/FT	\$0.86/FT

### E PRE-FOLDED

Folded in half down center. Width measured before folding. White.

1-1/2"	5oz	#2181	\$0.35/FT	\$0.32/FT
2"	5oz	#217	\$0.45/FT	\$0.41/FT
3"	5oz	#13800	\$0.50/FT	\$0.45/FT
4"	5oz	#201	\$0.65/FT	\$0.59/FT

### F FOAM LUFF PAD

Enhance rollerfurling headsails. Foam padding helps flatten sail when furled. Flatter sails reduce heeling and make the boat easier to steer. Does not absorb water.

Easy to cut and sew. Taper toward the sail's head and tack during installation so pad is proportional to the width of the sail when rolled. The center of the sail should remain flat by bulking up the roll.

Width: 12". Thickness: 3/16".

#103036 \$3.20/FT

## SAIL REPAIR MANUAL

by Jim Grant, 70 pp. Soft cover.

Learn to repair your own sails at sea and at home. Find step-by-step instructions and illustrations on sail patching and repair, correcting draft and seaming flaws, sail cleaning, and size modifications. Also includes hand stitching techniques and tips for sewing heavy sail cloth on a home sewing machine.

#36302 \$8.95 EA





## WEATHER STRIPPING



See how to install weather stripping in our "How to Make a Replacement Powerboat Bimini" video #X-HT-200660 (minute 01:18:20) at [Sailrite.com](https://www.sailrite.com)

### MARINE V-SEAL

Weather stripping foam designed with a smaller profile for sealing edges around tight corners, bow covers, and small cutouts. Excellent weather and water protection. Sew in place. Black. Width: 0.8".

#103713 \$1.70/FT

### MARINE ULTRA SEAL

Flat weather stripping foam designed to better accommodate fastener installation and sewing. Great for sealing edges around custom covers, convertible tops, dodgers, side curtains, windshield tops, radar arches and awnings. Recommended for use with Common Sense fasteners.

Sew in place. To sew, place under (on the inside of) the bound edge. Feed under sewing machine canvas side up. Install fasteners right through foam and fabric assembly. Black. Width: 1.8".

#103717 \$2.15/FT

### XTREME SEAL

Seal off custom covers, convertible tops, dodgers, side curtains, windshield tops, radar arches, and awnings. Closed-cell flexible foam creates a 3-point contact seal on most surfaces. Place under binding edge on the inside of finished surface and sew in place. To sew, run material and Xtreme Seal under sewing machine canvas side up. Install fasteners through foam and fabric assembly. Overall width: 2".

Black #102187 \$3.00/FT

White #102188 \$3.20/FT



## ZIPPERS



## ZIPPER GLOSSARY

**COIL ZIPPER** (p.158): Very strong, flexible, fine-toothed zipper. Great for bags, tents, packs, "smile" window openings and rounding corners or following difficult angles. Not recommended for extended outdoor use unless covered. YKK® AquaGuard® Zippers (p.159) are also coil zippers and are practically waterproof.

**VISLON ZIPPER** (p.156): Most common marine zipper. Very strong and scientifically designed to resist UV and corrosive damage. Plastic (Delrin) zipper teeth molded to zipper tape. Limited flexibility and difficult around curves.

**CONTINUOUS ZIPPER CHAIN:** Use in applications where at least one end of the zipper always stays closed (tote bag). No starter box or pin.

**FINISHED ZIPPER:** Use in applications where the zipper completely separates — like removable side curtains or jackets. Includes starter box and pin at one end and top stops at the other. Easy to shorten.

**LOCKING:** Zipper slider locks in place and grips the zipper chain to keep from moving until pull tab is tugged.

**NON-LOCKING:** Zipper slider only stays in place by friction and gravity. Open zipper with pull tab or grab the sides of the zipper and pull apart to force the slider down. Very useful in applications like headsail sleeves or socks.



## YKK® VISLON ZIPPERS

Super strong, smooth operating marine zippers for enclosures, bags, cushions, jackets, and covers. Expect high performance and durability even in harsh environments and extreme conditions on the water. UV and corrosion resistant and practically weatherproof.

### VISLON FINISHED ZIPPERS

Jacket-style YKK® #10 Vislon zippers with plastic sliders. Great for marine applications with UV and corrosion resistance. Available with single or double pull sliders at various lengths. Shorten zipper length by cutting down the end that closes last and installing new top stops (p.160). Teeth width (closed): 0.333" (8.49 mm).

See chart at right for sizes and pricing.

### VISLON CONTINUOUS ZIPPER CHAIN

YKK® Continuous zipper chain. Does not include zipper slider or top stops.

#5 Teeth width (closed): 0.225" (5.72 mm)

#10 Teeth width (closed): 0.333" (8.49 mm)

#5 White Vislon #28218 \$0.55/FT

#5 Black Vislon #100029 \$0.55/FT

#10 White Vislon #28212 \$0.95/FT

#10 Black Vislon #100030 \$0.95/FT



## #10 VISLON FINISHED ZIPPERS

	LENGTH	LOCKING/ NON-LOCKING	PART #	PRICE
BLACK	DOUBLE PULL	Locking	#104843-18-LK	\$5.10 EA
		Locking	#104843-24-LK	\$5.85 EA
		Locking	#104843-36-LK	\$7.35 EA
		Locking	#104843-48-LK	\$8.90 EA
		Locking	#104843-54-LK	\$9.65 EA
		Locking	#104843-60-LK	\$10.40 EA
		Locking	#104843-72-LK	\$11.90 EA
		Locking	#104843-84-LK	\$13.45 EA
		Locking	#104843-96-LK	\$14.95 EA
	Locking	#104843-120-LK	\$17.95 EA	
	Locking	#104843-180-LK	\$25.55 EA	
	SINGLE PULL	Locking	#104830-18-LK	\$4.25 EA
		Non-Locking	#104830-18-NL	\$4.55 EA
		Locking	#104830-24-LK	\$4.85 EA
		Non-Locking	#104830-24-NL	\$4.85EA
		Locking	#104830-36-LK	\$6.10 EA
		Non-Locking	#104830-36-NL	\$6.10 EA
		Locking	#104830-48-LK	\$7.30 EA
Non-Locking		#104830-48-NL	\$7.30 EA	
Locking		#104830-54-LK	\$7.95 EA	
Locking		#104830-60-LK	\$8.55 EA	
Non-Locking		#104830-60-NL	\$8.55 EA	
Locking		#104830-72-LK	\$9.80 EA	
Non-Locking		#104830-72-NL	\$9.80 EA	
Locking		#104830-84-LK	\$11.05 EA	
Locking		#104830-96-LK	\$12.25 EA	
Locking		#104830-120-LK	\$14.75 EA	
Non-Locking		#104830-120-NL	\$14.75 EA	
Locking		#104830-180-LK	\$21.65 EA	
Non-Locking	#104830-264-NL	\$30.00 EA		
WHITE	DOUBLE PULL	Locking	#104934-18-LK	\$5.10 EA
		Locking	#104934-24-LK	\$5.85 EA
		Locking	#104934-36-LK	\$7.35 EA
		Locking	#104934-48-LK	\$8.90 EA
		Locking	#104934-54-LK	\$9.65 EA
		Locking	#104934-60-LK	\$10.40 EA
		Locking	#104934-72-LK	\$11.90 EA
		Locking	#104934-84-LK	\$13.45 EA
		Locking	#104934-96-LK	\$14.95 EA
	Locking	#104934-120-LK	\$17.95 EA	
	Locking	#104934-180-LK	\$27.35 EA	
	SINGLE PULL	Locking	#104887-18-LK	\$4.25 EA
		Non-Locking	#104887-18-NL	\$4.25 EA
		Locking	#104887-24-LK	\$4.85 EA
		Non-Locking	#104887-24-NL	\$4.85 EA
		Locking	#104887-36-LK	\$6.10 EA
		Non-Locking	#104887-36-NL	\$6.10 EA
		Locking	#104887-48-LK	\$7.30 EA
Non-Locking		#104887-48-NL	\$7.30 EA	
Locking		#104887-54-LK	\$7.95 EA	
Locking	#104887-60-LK	\$8.55 EA		
Non-Locking	#104887-60-NL	\$8.55 EA		
Locking	#104887-72-LK	\$9.80 EA		
Non-Locking	#104887-72-NL	\$9.80 EA		
Locking	#104887-84-LK	\$11.05 EA		
Locking	#104887-96-LK	\$12.25 EA		
Locking	#104887-120-LK	\$14.75 EA		
Non-Locking	#104887-120-NL	\$14.75 EA		
Locking	#104887-180-LK	\$21.65 EA		
Non-Locking	#104887-264-NL	\$30.00 EA		
Non-Locking	#104887-360-NL	\$40.10 EA		
Non-Locking	#104887-480-NL	\$49.25 EA		



## NEW #10 VISLON FINISHED COLORED ZIPPERS

Choose a zipper that will blend right into your canvas! Jacket-style YKK® #10 Vislon zippers are available with colored tape and teeth to match the most popular shades of marine canvas. Treated with YKK's UV inhibitor to prolong the life of the vibrant color. Single, nickel-plated metal locking slider. Shorten zipper length by cutting down the end that closes last and installing new top stops (p.160). Teeth width (closed): 0.333" (8.49 mm)

See chart below for sizes and pricing.

	LENGTH	LOCKING/ NON-LOCKING	PART #	PRICE
BURGUNDY	36"	Locking	120946-36-LK	\$6.30 EA
	48"	Locking	120946-48-LK	\$7.65 EA
	60"	Locking	120946-60-LK	\$9.00 EA
CADET GREY	36"	Locking	120945-36-LK	\$6.30 EA
	48"	Locking	120945-48-LK	\$7.65 EA
	60"	Locking	120945-60-LK	\$9.00 EA
CAPTAIN NAVY	36"	Locking	120944-36-LK	\$6.30 EA
	48"	Locking	120944-48-LK	\$7.65 EA
	60"	Locking	120944-60-LK	\$9.00 EA

	LENGTH	LOCKING/ NON-LOCKING	PART #	PRICE
MARINE BLUE	36"	Locking	120947-36-LK	\$6.30 EA
	48"	Locking	120947-48-LK	\$7.65 EA
	60"	Locking	120947-60-LK	\$9.00 EA
NAVY	36"	Locking	120948-36-LK	\$6.30 EA
	48"	Locking	120948-48-LK	\$7.65 EA
	60"	Locking	120948-60-LK	\$9.00 EA
PACIFIC BLUE	36"	Locking	120949-36-LK	\$6.30 EA
	48"	Locking	120949-48-LK	\$7.65 EA
	60"	Locking	120949-60-LK	\$9.00 EA



#5 Actual Size

#10 Actual Size

◀ #5 Coil Finished

◀ #10 Coil Finished

◀ #4.5 Coil Continuous

◀ #5 Coil Continuous

#5 COIL ZIPPER TOP STOP #104408 \$0.95 PK10

◀ #10 Coil Continuous

#10 COIL ZIPPER TOP STOP #104409 \$1.00 PK10

◀ See p.160 for slider options

## YKK® COIL ZIPPERS

Strong, flexible fine-tooth coil zippers that are great for bags, tents, packs, "smile" window openings, and rounding corners or following difficult angles. Not recommended for extended use outdoors unless covered or if the application requires the zipper to take a curve.

### COIL FINISHED ZIPPERS

Jacket-style #5 or #10 Coil zippers with metal sliders. Shorten zipper length by cutting down the end that closes last and installing new top stops. Select a length and slider option when ordering online.

	LENGTH	LOCKING/ NON-LOCKING	PART #	PRICE
BLACK	#5 COIL	24" Locking	#104824-24-LK	\$2.25 EA
		24" Non-Locking	#104824-24-NL	\$2.25 EA
		36" Locking	#104824-36-LK	\$2.75 EA
		36" Non-Locking	#104824-36-NL	\$2.75 EA
		48" Locking	#104824-48-LK	\$3.25 EA
		48" Non-Locking	#104824-48-NL	\$3.25 EA
	#10 COIL	60" Locking	#104824-60-LK	\$3.75 EA
		60" Non-Locking	#104824-60-NL	\$3.75 EA
		24" Locking	#104901-24-LK	\$6.75 EA
		24" Non-Locking	#104901-24-NL	\$6.75 EA
		36" Locking	#104901-36-LK	\$8.55 EA
		36" Non-Locking	#104901-36-NL	\$8.55 EA
WHITE	#5 COIL	48" Locking	#104901-48-LK	\$10.35 EA
		48" Non-Locking	#104901-48-NL	\$10.35 EA
		60" Locking	#104901-60-LK	\$12.10 EA
		60" Non-Locking	#104901-60-NL	\$12.10 EA
		24" Locking	#104836-24-LK	\$2.25 EA
		24" Non-Locking	#104836-24-NL	\$2.25 EA
	#10 COIL	36" Locking	#104836-36-LK	\$2.75 EA
		36" Non-Locking	#104836-36-NL	\$2.75 EA
		48" Locking	#104836-48-LK	\$3.25 EA
		48" Non-Locking	#104836-48-NL	\$3.25 EA
		60" Locking	#104836-60-LK	\$3.75 EA
		60" Non-Locking	#104836-60-NL	\$3.75 EA

**BUY MORE, SAVE MORE!** Quantity pricing available at Sailrite.com

### COIL CONTINUOUS ZIPPER CHAIN

YKK® Continuous coil zipper chain. Does not include a zipper slider. Never completely separates. (at least one end must be sewn closed).

- #4.5 Teeth width (closed): 0.207" (5.20 mm)
- #5 Teeth width (closed): 0.250" (6.35 mm)
- #10 Teeth width (closed): 0.415" (10.54 mm)

- #4.5 Black Coil Continuous Chain #104386 \$0.25/FT
- #4.5 White Coil Continuous Chain #104385 \$0.25/FT
- #5 Black Coil Continuous Chain #104444 \$0.30/FT
- #5 White Coil Continuous Chain #104387 \$0.30/FT
- #5 Coil Zipper Top Stop #104408 \$0.95 PK10
- #10 Black Coil Continuous Chain #102215 \$0.95/FT
- #10 White Coil Continuous Chain #102214 \$0.95/FT
- #10 Coil Zipper Top Stop #104409 \$1.00 PK10



▲ YKK AquaGuard Water Repellent Zipper installed in Sunbrella canvas cover.



AQUAGUARD #10 FINISHED



AQUAGUARD #5 CONTINUOUS CHAIN



AQUAGUARD #10 CONTINUOUS CHAIN



Zipper Care & Lubricant p.165



**ZIPPER PULL TABS**  
Extend your grip when opening zippers, snaps, and shackles. Take apart to loop through zipper pulls or simply circle around an object and loop through itself.  
White #103682 \$3.50 PK10  
Black #99546 \$3.50 PK10

## YKK® AQUAGUARD® ZIPPERS

Practically waterproof zippers with great strength and smooth operation. Perfect for outdoor applications requiring moisture protection or an airtight seal. Polyurethane coating (shiny outer surface) increases water repellency but reduces flexibility.

YKK is the exclusive licensee of the water repellent slide fastener technology (U.S. Patent No. 6,105,214 and corresponding foreign patent).

### AQUAGUARD® FINISHED ZIPPERS

Jacket-style #10 YKK® coil zipper with non-locking metal slider, starter box, and pin. Shorten zipper length by cutting down the end that closes last and installing new top stops. Single pull. Black.

Width: 1.6" (40.64 mm)  
Teeth width (closed): 0.415" (10.54 mm).

	LENGTH	LOCKING/ NON-LOCKING	PART #	PRICE
BLACK	#10 COIL	24" Non-Locking	#104810-24	\$16.95 EA
		36" Non-Locking	#104810-36	\$20.95 EA
		48" Non-Locking	#104810-48	\$24.95 EA
		54" Non-Locking	#104810-54	\$26.95 EA
		60" Non-Locking	#104810-60	\$28.95 EA
		72" Non-Locking	#104810-72	\$32.95 EA
		96" Non-Locking	#104810-96	\$41.95 EA

**BUY MORE, SAVE MORE!** Quantity pricing available at Sailrite.com

### AQUAGUARD® CONTINUOUS ZIPPER CHAIN

YKK® AquaGuard® coil zipper chain. Does not include zipper slider. Never completely separates. (at least one end must be sewn closed).

- AquaGuard #5 Continuous Chain #104429 \$1.95/FT
- AquaGuard #10 Continuous Chain #104431 \$2.95/FT

### AQUAGUARD® ZIPPER SLIDERS

Select a properly sized YKK® AquaGuard® zipper slider for the AquaGuard® zipper chain.

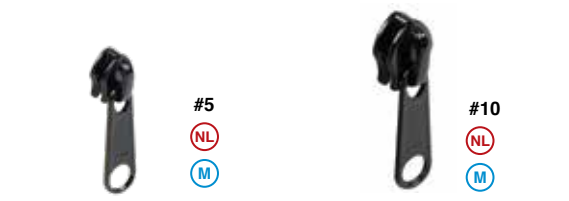

AquaGuard Reverse Tab Slider #104433  
1-99 \$0.45 EA  
100-499 \$0.38 EA  
500+ \$0.36 EA

AquaGuard Reverse Tab Slider #104435  
1-99 \$0.80 EA  
100-499 \$0.68 EA  
500+ \$0.64 EA



















(NL) Non-Locking (M) Metal

## YKK SLIDERS

Select a matching YKK® slider size and color. Single pull sliders open zipper from only one side of the application. Double pull sliders open zipper from both sides. Metal sliders are stronger, but plastic will not corrode.

**BUY MORE, SAVE MORE!** Quantity pricing available at Sailrite.com

### VISLON ZIPPER SLIDERS

 #5 L	 #5 NL	 #5 P	 #5 NL	 #5 M	 #5 M
WHITE #28219 \$0.40 EA BLACK #100034 \$0.40 EA	WHITE #103178 \$0.35 EA BLACK #103179 \$0.35 EA	WHITE #103161 \$0.30 EA BLACK #103154 \$0.30 EA	WHITE #103180 \$0.25 EA BLACK #103181 \$0.25 EA	WHITE #28220 \$1.00 EA BLACK #100032 \$1.00 EA	
 #5 NL	 #5 NL	 #10 P	 #10 NL	 #10 M	 #10 M
WHITE #103182 \$0.45 EA BLACK #103183 \$0.45 EA	WHITE #103155 \$1.00 EA	WHITE #28216 \$1.20 EA BLACK #100033 \$1.20 EA	WHITE #103186 \$1.20 EA BLACK #103187 \$1.20 EA	WHITE #103156 \$0.85 EA BLACK #103162 \$0.85 EA	
 #10 NL	 #10 NL	 #10 P	 #10 NL	 #10 M	 #10 M
WHITE #103188 \$1.05 EA BLACK #103189 \$1.05 EA	WHITE #28217 \$1.80 EA BLACK #100031 \$1.80 EA	WHITE #103190 \$1.40 EA BLACK #103191 \$1.40 EA	WHITE #103157 \$1.85 EA BLACK #103163 \$1.85 EA	WHITE #103192 \$1.70 EA BLACK #103193 \$1.70 EA NEW SILVER #120992 \$1.70 EA	

### COIL ZIPPER SLIDERS

 #4.5 L	 #4.5 NL	 #4.5 M
WHITE #104336 \$0.10 EA BLACK #104362 \$0.10 EA	WHITE #104335 \$0.15 EA BLACK #104361 \$0.15 EA	WHITE #104334 \$0.35 EA BLACK #104360 \$0.35 EA
 #5 L	 #5 NL	 #10 M
WHITE #104356 \$0.20 EA BLACK #104337 \$0.20 EA	WHITE #104333 \$0.20 EA BLACK #104359 \$0.20 EA	NEW WHITE #120865 \$1.25 EA NEW BLACK #120863 \$1.25 EA
 #10 NL	 #10 NL	 #10 M
WHITE #102217 \$0.60 EA BLACK #102216 \$0.60 EA	WHITE #102218 \$1.50 EA BLACK #103071 \$1.50 EA	

L Locking NL Non-Locking P Plastic M Metal

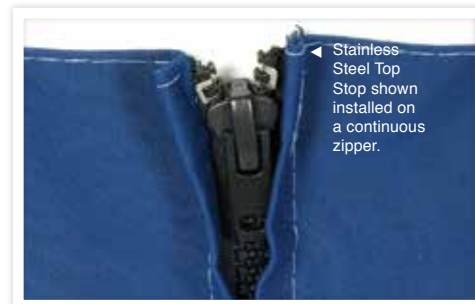

Stainless Steel Top Stop shown installed on a continuous zipper.



### VISLON ZIPPER STOPS

Create a new slider stop for shortened #10 Vislon continuous or finished zippers. Press top stop over each cut side of a finished zipper (end that closes last) or use both top and bottom stops for a continuous zipper. Bottom stop locks both sides of zipper together to stop the slider.

- A Top - White #351200 \$1.65 PK10
- B Top - Stainless Steel #100207 \$2.50 PK10
- C Bottom - White #354200 \$1.95 PK10



**CAMP WHITLEY**  
PONTOON BOAT MAKEOVER

## Helping Our Community and Our Customers

Last year we teamed up with several other local businesses to refurbish an old pontoon boat for an area summer camp, Camp Whitley. We were placed in charge of adding flooring, reupholstering the steering console, and building a bimini and bimini boot. Naturally, we also made how-to videos along the way!

See the full transformation of the pontoon and learn how you can recreate these projects for your boat at [Sailrite.com](http://Sailrite.com).



## CANVAS CARE

### A 303® FABRIC GUARD™

*Recommended by and for Sunbrella®*  
Restore water repellency, protect against oil based liquids and other stains, and provide UV screening to indoor and outdoor fabric, carpet, and upholstery. Does not affect the color, feel, or breathability of fabric or attract dirt. Mist over exposed surface. 16 oz. covers 50–100 sq. ft. Gallon covers 500–800 sq. ft. 16 oz. Spray **#481100 \$13.95 EA**  
Gallon **#501100 \$79.95 EA**

### B 303® MULTI-SURFACE CLEANER

*Recommended by and for Sunbrella®*  
Industrial strength concentrate cleaner for even the toughest cleaning jobs. De-greases engines, cleans oil tank holds, metals, paints, rubber, carpeting, vinyl and upholstery fabric. No harsh chemicals. Non-flammable. Safe enough to use as a hand cleaner or for washing fruits and veggies. 32 oz. spray. **#30553 \$11.95 EA**

### C IOSSO SEAM SEALER

Protect and seal sewn seams on boat covers, awnings, tents, and backpacks. Use on cotton, polyester, Sunbrella, and synthetic woven fabric. Does not affect fabric color or texture. Water repellency will vary on vinyl coated/laminated fabric due to seam construction. 4 oz. bottle. **#103015**  
1-11 **\$8.95 EA** 12+ **\$8.06 EA**

### D AQUA-TITE GREEN

*Recommended by and for Top Gun, Top Notch, Odyssey & Softouch*  
Premium grade water and stain repellent for use on cotton, acrylic, nylon, polyester, and polyester/cotton blends. Its active ingredient, Silicone, is considered to be one of the best water repellants available. Aqua-Tite Green meets all known regulations for VOC in the U.S. It is easy to apply but may impart a slightly darker, richer tone to light-colored fabric. Does not affect fabric breathability. Quart covers 125–175 sq. ft. Gallon covers 500–700 sq. ft. 32 oz. (Quart) **#125111 \$37.50 EA**  
128 oz. (Gallon) **#126111 \$115.00 EA**

## ADHESIVES

### HH-66 VINYL CEMENT

A quick, durable way to bond vinyl fabric like Shelter-Rite and Weblon Regatta to themselves or other materials. Very strong, waterproof, flexible, and resistant to temperature changes. Also use to seal sewn vinyl seams or to bond synthetic fabrics, leather, metals, plastics, and wood. Can be used instead of sewing. Dries in 2 to 5 minutes.

SIZE	PART #	1-11	12+
4 oz.	#103759	\$6.95 EA	\$6.60 EA
8 oz.	#1129	\$9.95 EA	\$9.45 EA
16 oz.	#103791	\$15.95 EA	\$15.15 EA
32 oz.	#101112	\$18.95 EA	\$18.00 EA
128 oz. (Gallon)	#103552	\$41.95 EA	\$39.85 EA

### HH-66 THINNER

Designed for use with HH-66 Vinyl Cement. May also be used to clean brushes, rollers, spray guns, and other types of applicators. Reactivates dried HH-66 or removes unwanted HH-66 from surfaces.

SIZE	PART #	1-11	12+
32 oz. (Quart)	#103557	\$11.95 EA	\$11.35 EA
128 oz. (Gallon)	#103564	\$27.95 EA	\$26.55 EA



## METAL CARE

### BOESHIELD T-9® RUST & CORROSION PROTECTION

Originally developed by Boeing® to displace moisture, attack corrosion, lubricate, and offer long-term protection for aircraft fasteners and fixtures. Safe on paints, plastics, or vinyls. Use above and below deck on standing rigging, swage joints, hinges, turn buckles, snap shackles, sail slides, electronics, running lights, engines, hull fittings, and sewing machine parts (when storing aboard). 4 oz. aerosol. **#86700 \$10.95 EA**

### BOESHIELD RUST FREE®

Rust and stain remover for steel, cast iron, stainless, chrome, tile, porcelain, concrete, vinyl and cloth. Use before coating metal parts with Boeshield T-9®. 8 oz. pump spray. **#90114 \$13.95 EA**

### IOSSO METAL POLISH

Remove oxidation, tarnish, surface rust, and water spots to leave a brilliant, shiny protective coating on stainless steel, aluminum, brass, copper, chrome, magnesium, silver, gold, porcelain, fiberglass, plexiglass, hard plastics, and painted surfaces. 3 oz. tube. **#646311 \$9.95 EA**

**TRIMMABLE #180 BUTYL TAPE**  
Non-hardening elastic butyl material that when pressed and formed around holes, fittings, and fasteners creates an air-tight, water-tight seal. Works on fiberglass, wood, metal, glass, plastics and porous surfaces. Adhesion increases with age after applied. One year shelf life. One year application warranty. Off white. Width: 3/4". 45 ft. roll. **#103689 \$9.95 EA**

**3M TAPE PRIMER 94 - ADHESIVE PROMOTER**  
Specially designed to help 3M adhesive products stick and stay anywhere! Works on a variety of surfaces including: polyethylene, polypropylene, ABS, PET/PBT blends, painted metal surfaces, metal, glass, wood, and concrete. Recommended for use with YKK SNADS. 1/2 Pint **#104166 \$18.95 EA**  
0.66 mL Ampule **#120671 \$1.95 EA**

**TEAR MENDER**  
Fabric cement that bonds acrylics like Sunbrella, cotton duck, and other natural fabrics, as well as zippers, leathers, and nylons. UV resistant and great for outdoor use. Penetrates and dries in seconds for a waterproof bond. Hand spout applicator. 6 oz. bottle. **#419100 \$11.95 EA**

**3M SUPER 77 SPRAY ADHESIVE**  
Fast, aggressive, clear tack that bonds fabric firmly in place prior to sewing. Great for corner patch assemblies on sails, headliner installation, or holding Sunbrella in place during roller furling sun cover installation. Spray on both surfaces and assemble. Covers about 220 sq. ft. Easy to use. Bonding range: 15 minutes. 16.75 oz. aerosol. **#636100 \$16.95 EA**

**NEW AAT-390 MARINE & EXTERIOR ADHESIVE**  
A copolymer adhesive designed for installing marine carpets. Extremely water resistant, non-flammable, freeze and thaw stable and solvent-free. Protected by CleanGuard® two-stage antimicrobial to protect against micro-organisms when both wet and dry. Recommended for use with Infinity Luxury Woven Vinyl (p.79), Chilewich (p.78) and other marine or outdoor carpets. Cannot be used with carpets that have urethane unitary backings. 1 gallon bucket. **#121096 \$42.95 EA**

**FOAM LOCK SPRAY ADHESIVE**  
A quick-tack, high coverage versatile adhesive! Creates a strong bond between porous surfaces like fabric and foam as well as non-porous surfaces like wood, metal or plastic. Very little soak-in prevents bleed through on fabrics. Great for headliner and hull liners. Not recommend for unsupported vinyl. Bonding range: 10 sec. to 15 min. 12 ounce aerosol. **#120464 \$7.95 EA**

**3M SUPER TRIM ADHESIVE**  
Fast acting, high-strength, aerosol contact adhesive for bonding vinyl tops, adhering Reflex or closed cell foam, and attaching heavyweight headliner and hood silencer pads. Excellent heat, water and plasticizer resistance. Not recommended for polyethylene, polypropylene, or foamed polystyrene. Bonding range: 4-30 minutes. 19 oz. aerosol. **#108090 \$28.95 EA**

**3M GENERAL TRIM ADHESIVE**  
Great for lightweight headliners and fabrics including cloth-backed flexible vinyl, foam, and insulation. Non-staining. Good heat and water resistance. Covers about 3 yards of headliner material. Bonding range: 15 minutes. 18.1 oz. aerosol. **#73211 \$22.95 EA**

**3M FAST CURE 5200 ADHESIVE**  
A high performance, flexible polyurethane. Extremely strong seal that retains strength above or below the water line. Use to adhere patches, hardware, and sacrificial cover material to sailcloth. Tack free within an hour, fully cures in 24 hours. White. 3 oz. tube. **#100262 \$18.95 EA**

**3M MARINE MILDEW RESISTANT SILICONE**  
Excellent galley and head sealant, gasket adhesive, or bedding compound for portholes, hatches, marine hardware, windows, doors, bathtubs and showers. Seals and waterproofs. Remains flexible. May be used on Plexiglass and Lexan. Not intended for continuous use below the water line. 3 oz. tube. **#108016 \$12.95 EA**

Flammable (p.256)

## BOAT CARE KITS



### NEW IMAR CAPTAIN'S BUCKET

The ultimate boat cleaning kit, this bucket contains eight, full-size 16-ounce cleaners and polishes for cleaning and protecting your boat and clear vinyl. Contains: Strataglass Protective Cleaner, Strataglass Protective Polish, Yacht Soap Concentrate, Yacht Polish, Yacht Clean & Shine, Multi-Purpose Marine Cleaner, Vinyl and Rubber Protectant and Yacht Metals Protective Polish (12-ounce tub). Also includes a 2-1/2 gallon bucket and 3 sponges.

#121035 \$99.95 EA



### NEW IMAR MARINER'S BUCKET

Keep every inch of your boat looking shiny and new with four, full-size, 16-ounce cleaners plus a 2-1/2 gallon bucket and a sponge. Great for deep cleaning and everyday maintenance! Contains: Yacht Soap Concentrate, Yacht Polish, Yacht Clean & Shine and Multipurpose Marine Cleaner.

#121033 \$49.95 EA



### NEW IMAR STRATAGLASS CARE BUCKET

Everything you need to care for your Strataglass or other clear vinyl in one kit! Use these three, full-size cleaners to clean and protect your clear vinyl. Contains: Strataglass Protective Cleaner, Strataglass Protective Polish and Yacht Soap Concentrate. This kit also includes a 2-1/2 gallon bucket and a sponge.

#121032 \$49.95 EA

## VINYL CARE

### IMAR™ 3-PART SYSTEMS

ENDORSED FOR USE ON STAMOID (p.24)



- CLEAN IMAR™ STAMOID MARINE VINYL CLEANER**  
Specially formulated gentle vinyl cleaner for Stamoid and other marine vinyls. Use frequently, especially in areas of high environmental pollution. Use with IMAR Stamoid Marine Vinyl Protective Cream and Spray to maintain a like-new appearance. Safe around Strataglass and other clear vinyl when used properly. 16 oz. spray bottle.  
#102354 \$17.95 EA



- PROTECT IMAR™ STAMOID MARINE VINYL PROTECTIVE CREAM**  
Extend the life of Stamoid and other vinyls with this protective barrier. Polymer-based formula keeps vinyl static resistant, pliable, and radiant. Use every 2 to 3 months after cleaning. 16 oz. bottle.  
#102352 \$18.95 EA



- MAINTAIN IMAR™ STAMOID MARINE VINYL PROTECTIVE SPRAY**  
Use for routine maintenance on Stamoid and other vinyls between cleanings. Works as a great spot cleaner and rejuvenates IMAR Protective Cream. 16 oz. spray bottle.  
#102353 \$17.95 EA

ENDORSED FOR USE ON ALL CLEAR VINYL (p.88)



- CLEAN IMAR™ YACHT SOAP CONCENTRATE**  
No-streak, no-spot soap formula for vinyl windows that rinses clear, dries fast, and results in a highly polished appearance. No harsh alkalis, acids, or abrasives. The perfect compliment to Strataglass Protective Cleaner and Polish. 16 oz. bottle.  
#100528 \$11.95 EA



- POLISH & PROTECT IMAR™ STRATAGLASS PROTECTIVE POLISH**  
Safely clean, polish, and protect Strataglass and its scratch resistant protective coating with this polymer-based polish. The secret is the molecular bonding that creates a nearly invincible protective barrier against marine environment pollutants. Recommended use every 3 to 4 months (4 to 6 weeks in high fallout areas). 16 oz. bottle.  
#100928 \$19.95 EA



- MAINTAIN IMAR™ STRATAGLASS PROTECTIVE CLEANER**  
Extend the life of Strataglass! Uniquely designed with UV inhibitors to clean, shine, and protect Strataglass and its scratch resistant protective coating from the damaging effects of sunlight. Rejuvenates IMAR Strataglass Protective Polish and promotes continued flexibility. Safe to use daily. 16 oz. spray bottle.  
#100927 \$17.95 EA



### NEW IMAR STRATAGLASS DETAILING 3 PAK KIT

The perfect starter kit for clear vinyl care! This pack contains a four ounce bottle of Strataglass Protective Cleaner, Strataglass Protective Polish and Yacht Soap Concentrate for deep cleaning and everyday maintenance of your Strataglass and other clear vinyl.

#121031 \$13.95 EA

# No mess is too sticky

## Make Clean-up a Snap with 3M Adhesive Cleaner

### 3M GENERAL PURPOSE ADHESIVE CLEANER

Recommended for removing sail number adhesive!

Easy cleanup for most adhesives. Special-blend solvent quickly removes wax, grease, oil, and tar. Safe on dried paint, vinyl, or fabric (including Dacron) when used properly. Great for removing adhesive overspray when installing headliner. 32 oz. can.

#108984 \$21.95 EA



## MULTI-PURPOSE PRODUCTS



### IOSSO SAFE-T-SOLVE

Industrial strength, fast acting cleaner/degreaser that penetrates and lifts heavy grease and oil, adhesives, ink, marker, black streaks, tar, dried bugs, graffiti, gum, and more. Water base, non-petroleum, biodegradable formula. No hazardous ingredients. High flash point, low VOC. EPA registration not required. 32 oz. spray.

#103022 \$16.95 EA



### IOSSO MOLD & MILDEW STAIN REMOVER

Remove algae stains, dirt, and oils on vinyl, plastic, canvas, carpeting, wood, fiberglass, sails, and painted surfaces. Biodegradable, nontoxic powder. Makes 3 gallons and covers up to 150 sq. ft. 12 oz. jar.

#214190 \$15.95 EA



### MCLUBE SALKOTE

Recommended by Harken® for everything that moves!

High performance dry lubricant for more efficient, smooth, longer-lasting movement of sails, hulls, rigging, and deck hardware. Formulated with environmentally friendly Dupont Krytox® for a hard, smooth, ultra-slick, hydrophobic clear coating that bonds tenaciously to almost any surface. Does not attract dirt, water, or contaminants that degrade performance. Used and approved by sailors across the globe. 16 oz. Aerosol.

8 oz #120679 \$14.95 EA



### 303® AEROSPACE PROTECTANT™

Keep your boat looking "like new" year after year with SPF 40. Reduces fading degradation and non-oily, anti-static finish repels dust, dirt and staining. Protect vinyl, rubber, plastic, fiberglass, Dacron, monofilm, finished leather, webbing, clear vinyl windows, inflatables, and zipper teeth. Do NOT use on acrylic fabrics! Does not contain silicone, oils, waxes, glycerin or petroleum distillates. Apply 1-2 times a year.

16 oz. Trigger Sprayer #980111 \$11.95 EA

Gallon #991111 \$54.95 EA

Flammable (p.256)

## TEAK CARE

### IOSSO TEAK CLEANER

Clean and brighten wood in one easy step. Removes dirt, mildew stain, black algae, and oil stains and restores a bright natural look to weathered teak. Use on teak, pressure treated pine, cedar, and other woods. Safe around fabric, carpet, metal, or fiberglass. Biodegradable. Mix with water. Jar makes 4 gallons. 16 oz. jar.

#103277 \$15.95 EA



## ZIPPER LUBRICANT

### ZIPPY COOL KIT

Extend the life of zipper teeth. An effective 'non-silicone' way to clean and lubricate all types of zippers. Includes 2 oz. cleaning fluid, 0.5 oz. wax lubricant, and application brush.

#350011 \$14.95 EA



### IOSSO E-Z SNAP ZIPPER & SNAP LUBRICANT

Lubricate, waterproof, and reduce friction on snaps, zippers, hinges, and hardware. Keeps zippers sliding smoothly and snaps from corroding and locking up. Water and heat resistant. Non-hazardous, does not contain solvents, silicone or Teflon. 1.5 oz. tube.

#103019 \$5.95 EA



## FIBERGLASS CARE

### IOSSO FIBERGLASS RECONDITIONER

Restore color to faded fiberglass and remove oxidation, chalking, water-line, water spots, tars, and oils to leave a brilliant protective coating that lasts for months. Coating does not need waxed. Contains no silicone. Cleans a 30' boat from the waterline up.

16 oz. jar.  
#103021 \$23.95 EA



# FASTENER SELECTION GUIDE

Sailrite is proud to carry DOT® and Loxx® brand fasteners for canvas use. DOT Fasteners have been the #1 choice of the world's leading marine and industrial product manufacturers for over 80 years, thanks to their heavy-duty construction, uniform engineering & unmatched strength. Loxx Fasteners are manufactured in Germany using only the highest quality materials and offer superior performance over look-alike fasteners. Use this guide to compare the differences between our full line of fastener brands and types.

TYPE	PROFILE	STRENGTH	EASE OF INSTALLATION
DOT® Durable Snap Fasteners	Low	Good	Easy
Lift-The-Dot®	Medium	Better	Moderate
Loxx® Pull It Up	Medium	Best	Easy
Pull-The-Dot®	Low	Better	Hard
Common Sense™	High	Best	Moderate

## DOT® DURABLE SNAP FASTENERS - LIGNE 24 p.168

The most common fastener used in marine applications. Great for boat covers, dodgers, and tarps or on tabs of fabric or webbing for forestay hanks on sails under 100 sq. ft. Highly resistant to corrosion.

**PROFILE:** Low profile with smooth domed button top. Looks great and button caps are available in popular canvas colors.

**STRENGTH:** Very easy to fasten with moderate connection strength. The overall shear strength is excellent, but one pull on an angle and the fastener will pop free. Stainless steel snaps have slightly better strength.

**EASE OF INSTALLATION:** A Snap Fastener Installation Tool (#25204, p.167) or Deluxe Snap Fastener Anvil Tool (#100949, p.167) is required for installation. Use the Pres-N-Snap Tool (#109011, p.175) or the SnapRite System (#104500, p.171) for quicker, more efficient installation.

## DOT® LIFT-THE-DOT® FASTENERS p.173

Often used to secure boat covers and dodgers.

**PROFILE:** Medium profile and fastener will stick up above the application. Can stub your toe on it.

**STRENGTH:** Only opens when lifted from one side. Unlikely to come undone when peeled from the other side. Fantastic shear strength.

**EASE OF INSTALLATION:** Cutting holes for the eyelet side is best done with a special hole cutter. Folding the prongs over by hand can be tedious. Eyelet Type Lift-The-Dot Fasteners can be installed with the Pres-N-Snap Tool (#109011, p.175) and the Lift-The-Dot Eyelet Type Base Die Set (#106397, p.175).

## LOXX® PULL IT UP FASTENERS p.178

A cleverly engineered, self-locking snap fastener that is great for applications where security, low profile, and performance are important. Ideal for marine, leather, and automotive applications.

**PROFILE:** Medium height profile but low enough to be toe friendly and very attractive.

**STRENGTH:** Very positive connectivity and can only be released by lifting up on the spring loaded cap.

**EASE OF INSTALLATION:** Requires only an inexpensive key (#3630002, p.179) and hole cutter. All components screw or bolt together.

## DOT® PULL-THE-DOT® (ONE WAY) FASTENERS p.178

Uniquely designed, three-sided built-in locking snap fastener that can withstand extreme pressure on three sides without unlocking. Well suited for applications where the strain on the snap is not shear, like on the front panel of a dodger. Highly resistant to corrosion.

**PROFILE:** Low profile with smooth domed button top.

**STRENGTH:** Strong, positive hold. Pull from the protrusion side to open. Close the snap by closing the lip side first and then the protrusion side.

**EASE OF INSTALLATION:** Keeping the sockets and buttons aligned consistently can be a challenge. The stud can be installed as normal, but the socket must be installed so the protrusion is on the side that is to be released easily. As with normal snap fasteners, use of the Pres-N-Snap (#109011, p.175) with the appropriate die or the SnapRite System (#104500, p.171) is preferred.

**PROFILE:** The profile of a fastener is how high the fastener stands above the application once installed. A low profile fastener will be almost smooth or flush with the application, and a high profile fastener stands up high enough that it can easily be grabbed but could also stub a toe or snag something in passing.

**STRENGTH:** The strength of a fastener can be very important depending on the application and location of the fastener. The more positive (or stronger) a connection, the more resistant the fastener is to coming apart.

**EASE OF INSTALLATION:** Ease of installation is determined by the number of tools required and how easy the fastener is to install properly.

## COMMON SENSE™ / TWIST-LOCK FASTENERS p.176

A quick and secure way to fasten pieces of fabric together or to a solid surface. Often used to hold covers and enclosures in place. Designed specifically for wet environments.

**PROFILE:** Very high profile stud. Easy to grab and locate, but stands high off the application.

**STRENGTH:** Requires a manual twist of the fastener stud to lock and release. Common Sense fasteners will not come undone.

**EASE OF INSTALLATION:** Installation of most parts can be completed without any special tools but is much quicker and more efficient with the proper tools. A Snap Fastener Installation Tool (#25204, p.167), Deluxe Snap Fastener Anvil Tool (#100949, p.167) or the SnapRite Twist Lock Die Kit (#104619, p.172) is required to install buttons, and a #2 Hole Cutter (#18211, p.179) or the Common Sense Hole Cutter (#108001, p.177) makes eyelet installation much easier. Install the Common Sense Barrel Stud with the Pres-N-Snap Tool (#109011, p.175) and the Turn Lock Die Set (#104993 p.175).

For cloth-to-surface applications, use a Single Screw Common Sense Driver Tool (#100135, p.177) to drill the stud into a hard surface.

## FASTENER TOOL SELECTION GUIDE

Determine what tools are needed to install each fastener. p.248



### A SNAP FASTENER KIT

Includes: Deluxe snap installation tool, 1/8" hole cutter, 50 silver buttons (40 - 11/64" barrel & 10 - 1/4" barrel), 60 normal action sockets, 30 eyelets, 30 eyelet studs, 20 screw studs (10 - 5/8" & 10 - 3/8" (#8-15 self-tap)), 10 gypsy studs (3/16" barrel), large waterproof storage box (colors vary).  
#102581 \$96.95 KIT

### B SAILRITE® SNAP FASTENER DELUXE INSTALLATION TOOL

Heavy-duty metal anvil tool for installing button snap fasteners. Can be used frequently even on stainless steel snaps. Use without base to set rivets. Installs: A, SRA, B, C, D, SRG, R, SRR, S, T, SSA, SSB, SSC & SSD. Made in the USA.

#100949 \$29.95 EA

### C SNAP FASTENER INSTALLATION TOOL

Small metal anvil tool for installing button snap fasteners. Ideal for Common Sense button-back screw studs. Not recommended for stainless steel snaps. Use without base to set rivets. Installs: A, SRA, B, C, D, R, SRR, S, & T.

#25204 \$2.95 EA

### D DECK MATE TOOL

Six of your most commonly used tools in one! Dual-head design with a flat-head screwdriver, shackle key, 1/4" hex head driver, 2 universal deck keys, zipper/toggle pull, and bottle opener. No-slip, ergonomic rubberized handle for both right and left-handed users. Built-in lanyard loop for convenience.

#102206 \$19.95 EA

### E TOP-SNAPPER®

Fasten and unfasten boat canvas in a snap! Quickly push or pull snaps into place. Use the long blade from the inside, short blade on outside snaps, and notches to slip over the cap or shoulder of the snap. Easy-to-grip ergonomic handle.

#100590 \$19.95 EA

# DOT® DURABLE SNAP FASTENERS - LIGNE 24

Use on boat covers, dodgers, and tarps or install on tabs of fabric or webbing and use as forestay hanks for sails under 100 sq. ft. Choose from top quality nickel-plated brass with bronze springs (surface studs have stainless steel screws) or from 100% stainless steel snap fasteners.

All fasteners are highly resistant to corrosion. Installation tools are required. Use either the Snap Fastener Installation Tool (#25204) or the Deluxe Snap Fastener Anvil Tool (#100949), or for quicker installation, use the Pres-N-Snap Tool (#109011) or the SnapRite System (#104500).

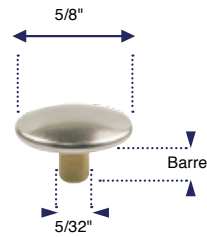

## CLOTH-TO-CLOTH (C-C) CLOTH-TO-SURFACE (C-S)

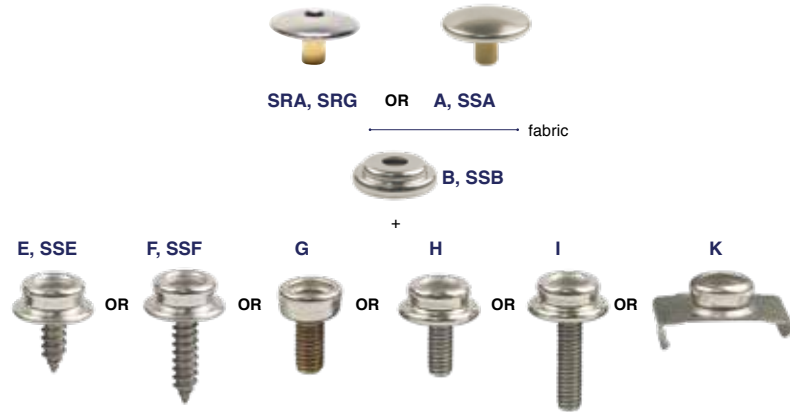
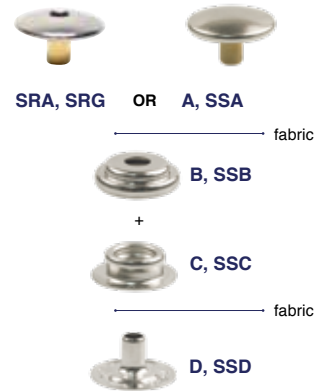

## CLOTH-TO-CLOTH-TO-CLOTH (C-C-C) CLOTH-TO-CLOTH-TO-SURFACE (C-C-S)

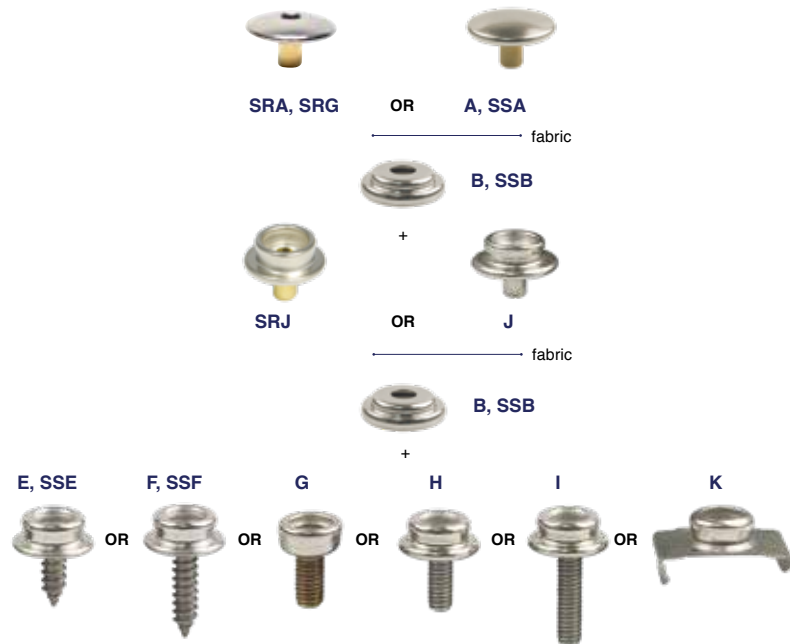
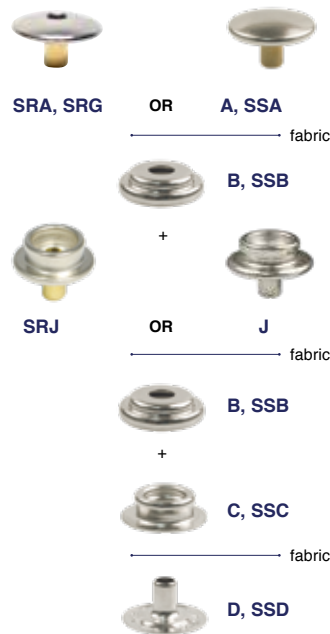

### FASTENER TOOL SELECTION GUIDE

Determine what tools are needed to install each fastener. p.248

COMPLETE SETS*	C-C	C-S	PART #	1-9 PK	10-99 PK	100+ PK
Silver Button Set (4 pc.) Nickel-plated Brass (A <sup>1</sup> , B <sup>2</sup> , C, D <sup>1</sup> )	•		#333001	\$3.85 PK10	\$3.27 PK10	\$3.08 PK10
Silver Button, 3/8" Screw Set (3 pc.) Nickel-Plated Brass (A <sup>1</sup> , B <sup>2</sup> , E)		•	#333002	\$5.35 PK10	\$4.55 PK10	\$4.28 PK10
Silver Button, 5/8" Screw Set (3 pc.) Nickel-Plated Brass (A <sup>1</sup> , B <sup>2</sup> , F)		•	#333003	\$5.35 PK10	\$4.55 PK10	\$4.28 PK10
Silver Button Set (4 pc.) Stainless Steel (SSA <sup>1</sup> , SSB <sup>2</sup> , SSC, SSD <sup>1</sup> )	•		#444001	\$5.35 PK10	\$4.55 PK10	\$4.28 PK10
Silver Button, 3/8" Screw Set (3 pc.) Stainless Steel (SSA <sup>1</sup> , SSB <sup>2</sup> , SSE)		•	#444002	\$6.55 PK10	\$5.57 PK10	\$5.24 PK10
Silver Button, 5/8" Screw Set (3 pc.) Stainless Steel (SSA <sup>1</sup> , SSB <sup>2</sup> , SSF)		•	#444003	\$6.55 PK10	\$5.57 PK10	\$5.24 PK10
SnapRite Button Set (4 pc.) Nickel-Plated Brass (SRA <sup>1</sup> , B <sup>2</sup> , C, D <sup>1</sup> )	•		#104909	\$4.35 PK10	\$3.70 PK10	\$3.48 PK10
SnapRite Button Set (4 pc.) Stainless Steel (SRG <sup>1</sup> , SSB <sup>2</sup> , SSC, SSD <sup>1</sup> )	•		#104910	\$5.60 PK10	\$4.76 PK10	\$4.48 PK10
SnapRite Button, 3/8" Screw Set (3 pc.) Nickel-Plated Brass (SRA <sup>1</sup> , B <sup>2</sup> , E)		•	#104911	\$5.85 PK10	\$4.97 PK10	\$4.68 PK10
SnapRite Button, 3/8" Screw Set (3 pc.) Stainless Steel (SRG <sup>1</sup> , SSB <sup>2</sup> , SSE)		•	#104912	\$6.80 PK10	\$5.78 PK10	\$5.44 PK10

KEY	COMPONENTS (NICKEL-PLATED)	C-C	C-S	C-C-C	C-C-S	PART #	1-9 PK	10-99 PK	100+ PK
A <sup>1</sup>	Silver Button, 11/64" Barrel	•	•	•	•	#333777	\$1.45 PK10	\$1.30 PK10	\$1.23 PK10
SRA <sup>1</sup>	SnapRite Silver Button, 11/64" Barrel	•	•	•	•	#104151	\$1.95 PK10	\$1.76 PK10	\$1.66 PK10
A <sup>1</sup>	Colored Button, 3/16" Barrel (Black or White)	•	•	•	•	SEE COLOR CHART	\$1.95 PK10	\$1.76 PK10	\$1.66 PK10
A <sup>1</sup>	Colored Button, 3/16" Barrel (Navy or Blue)	•	•	•	•	SEE COLOR CHART	\$3.95 PK10	\$3.56 PK10	\$3.36 PK10
A <sup>1</sup>	Silver Button, 1/4" Barrel	•	•	•	•	#333010	\$1.40 PK10	\$1.26 PK10	\$1.19 PK10
SRA <sup>1</sup>	SnapRite Silver Button, 1/4" Barrel	•	•	•	•	#104154	\$1.95 PK10	\$1.76 PK10	\$1.66 PK10
A <sup>1</sup>	Silver Button, 5/16" Barrel	•	•	•	•	#333012	\$2.95 PK10	\$2.66 PK10	\$2.51 PK10
B <sup>2</sup>	Normal Action Socket	•	•	•	•	#333050	\$0.95 PK10	\$0.86 PK10	\$0.81 PK10
B <sup>3</sup>	Hard Action Socket	•	•	•	•	#333058	\$0.95 PK10	\$0.86 PK10	\$0.81 PK10
C	Stud	•		•		#333100	\$0.75 PK10	\$0.68 PK10	\$0.64 PK10
D <sup>1</sup>	Eyelet, 1/4" Barrel	•		•		#333555	\$0.70 PK10	\$0.63 PK10	\$0.59 PK10
D <sup>1</sup>	Eyelet, 5/16" Barrel	•		•		#333558	\$0.75 PK10	\$0.68 PK10	\$0.64 PK10
E	3/8" Screw Stud (8-15 Self-Tap)		•		•	#333105	\$2.95 PK10	\$2.66 PK10	\$2.51 PK10
F	5/8" Screw Stud (8-15 Self-Tap)		•		•	#333110	\$2.95 PK10	\$2.66 PK10	\$2.51 PK10
G	3/8" Machine Screw (10-32)		•		•	#333115	\$4.95 PK10	\$4.46 PK10	\$4.21 PK10
G	5/8" Machine Screw (10-32)		•		•	#333118	\$4.95 PK10	\$4.46 PK10	\$4.21 PK10
H	3/8" Machine Screw (8-32)		•		•	#333120	\$3.95 PK10	\$3.56 PK10	\$3.36 PK10
I	5/8" Machine Screw (8-32)		•		•	#333125	\$3.95 PK10	\$3.56 PK10	\$3.36 PK10
J <sup>1</sup>	Gypsy Stud, 3/16" Barrel			•	•	#333130	\$2.95 PK10	\$2.66 PK10	\$2.51 PK10
SRJ	SnapRite Gypsy Stud, 3/16" Barrel			•	•	#104236	\$2.95 PK10	\$2.66 PK10	\$2.51 PK10
K	3/4" Windshield Clip		•		•	#333135	\$3.95 PK10	\$3.56 PK10	\$3.36 PK10
K	7/8" Windshield Clip		•		•	#333138	\$4.95 PK10	\$4.46 PK10	\$4.21 PK10

KEY	COMPONENTS (STAINLESS STEEL)	C-C	C-S	PART #	1-9 PK	10-99 PK	100+ PK
SSA <sup>1</sup>	Silver Button, 11/64" Barrel	•	•	#444777	\$1.70 PK10	\$1.53 PK10	\$1.44 PK10
SSA <sup>1</sup>	Silver Button, 1/4" Barrel	•	•	#444888	\$1.70 PK10	\$1.53 PK10	\$1.44 PK10
SRG <sup>1</sup>	SnapRite Silver Button, 5/32" Barrel	•	•	#104153	\$1.95 PK10	\$1.76 PK10	\$1.66 PK10
SRG <sup>1</sup>	SnapRite Silver Button, 1/4" Barrel	•	•	#444004	\$1.95 PK10	\$1.76 PK10	\$1.66 PK10
SSB <sup>2</sup>	Normal Action Socket	•	•	#444050	\$1.90 PK10	\$1.71 PK10	\$1.62 PK10
SSC	Stud	•		#444100	\$0.90 PK10	\$0.81 PK10	\$0.77 PK10
SSD <sup>1</sup>	Eyelet, 1/4" Barrel	•		#444555	\$0.85 PK10	\$0.77 PK10	\$0.72 PK10
SSE	3/8" Screw Stud (8-15 Self-Tap)		•	#444105	\$2.95 PK10	\$2.66 PK10	\$2.51 PK10
SSF	5/8" Screw Stud (8-15 Self-Tap)		•	#444110	\$2.95 PK10	\$2.66 PK10	\$2.51 PK10

<sup>1</sup> 11/64" or 3/16" - most common barrel lengths for regular thickness fabric assemblies.  
<sup>1/4"</sup> barrel length for fabric assembly thickness of up to 3/16"  
<sup>5/16"</sup> barrel length for fabric assembly thickness of up to 1/4"

<sup>2</sup> Normal Action - Snaps come apart with normal force.  
<sup>3</sup> Hard Action - Snaps come apart with additional force.  
 \*Complete sets come with the shortest barrel button.

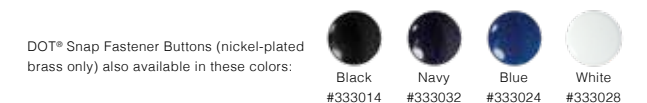



# SNAPRITE® SYSTEM

Turn a standard rivet gun into a snap installation tool! The secret to the SnapRite System is 4 unique, color-coded dies designed to work in pairs to install button, socket, stud, and eyelet fastener components quickly and easily. The SnapRite dies screw into the nosepiece of any common rivet tool and must be used with a SnapRite mandrel. Use the SnapRite System to install snaps on site for accurate positioning every time.

The SnapRite System requires the use of SnapRite buttons and gypsy studs but installs all other standard snap components in a Ligne 24 size.

## MUST-HAVE FEATURES:

- Sets in one step (no pre-punching holes!)
- Conveniently portable (no workbench needed)
- Perfect positioning in any location (no tool restrictions)
- Works with any standard rivet tool
- Installs DOT® Snap fasteners, Pull-The-Dot®, gypsy studs, and more



Example:  
Snap Button & Socket Installation

## SIMPLE INSTALLATION

Dies work in pairs and are color-coded to show which dies are compatible.



1. Screw top die into rivet gun nosepiece.
2. Insert snap component into nosepiece die.
3. Insert mandrel up through base die and place snap component.
4. Set base die in desired snap location. Press mandrel through fabric.
5. Use gun to rivet components.
6. Separate base die from snap component.

# COMPLETE SNAPRITE® SYSTEM

The SnapRite System features a set of four dies that work with a standard rivet gun to install button, socket, stud, and eyelet snap fastener components with more ease, speed, and precision than ever before. This Complete Kit comes with all the tools you need (except snap fasteners) to start installing snaps.

## INCLUDES:

- Professional Heavy Duty Rivet Tool
- SnapRite Button Die
- SnapRite Socket Die
- SnapRite Stud Die
- SnapRite Eyelet die
- 100 SnapRite Mandrels
- Storage Pouch for Dies
- Durable carrying case
- Instructions

#104500 \$130.35 KIT



## SNAPRITE® SYSTEM

Includes: SnapRite Button, Socket, Stud, & Eyelet dies, SnapRite mandrels (100pk) and storage pouch.

#104237 \$95.45 KIT



Complete SnapRite System (#104500)

## SNAPRITE® SURFACE MOUNT STUD DIE

Quickly and easily install snap studs into a hard surface using this uniquely designed die that screws into the end of a standard rivet tool. Die holds rivet and stud in place so parts are not loose or falling off during installation.

This screw-in stud alternative results in a tight fitting, lower profile stud. Use with a closed end rivet and foam gasket for a watertight seal. Installs studs to fiberglass, stainless steel or aluminum tubing, galvanized pipe, and other hard materials that can be riveted. Made in the USA.

#103754 \$24.95 EA

## BLIND RIVETS

- A Aluminum-Open End #103756 \$1.45 PK10
- B Stainless Steel - Open End #103755 \$2.65 PK10
- C Stainless Steel - Closed End #104170 \$4.95 PK5
- D Aluminum - Closed End w/Gasket #104169 \$9.95 PK5

## FOAM GASKET

- Adhere under a stud to waterproof base.
- E Adhesive-Backed #104171 \$9.10 PK100

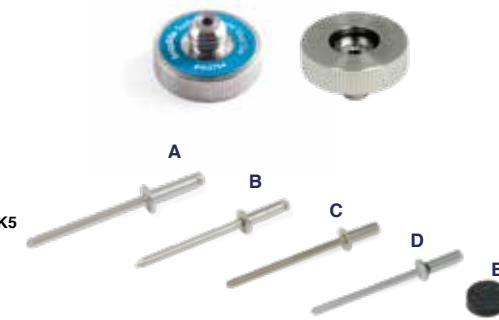

**ACCESSORY CARRYING CASE**  
Durable plastic carrying case with foam lining. Large enough to fit a standard rivet tool.  
#103798 \$10.95 EA



**PROFESSIONAL RIVET TOOL**  
A professional rivet tool with a heavy duty steel construction. Spring-loaded handles for easy loading. Includes 3/32", 1/8", 5/32", and 3/16" nosepieces.  
#103520 \$23.95 EA



## SNAPRITE® STARTER FASTENER KIT

Get 260 snap components for cloth-to-cloth and cloth-to-surface applications including Pull-The-Dot® fasteners and gypsy studs (nickel-plated brass). All components are compatible with the SnapRite System.

### KIT INCLUDES:

- 20 SnapRite® Snap Fastener Buttons Silver 1/4" Barrel #104154 (p.169)
- 20 SnapRite® Snap Fastener Buttons Silver 11/64" Barrel #104151 (p.169)
- 40 Snap Fastener Normal Action Sockets #333050 (p.169)
- 20 DOT® Snap Fastener Hard Action Sockets #333058 (p.169)
- 10 DOT® Snap Fastener Screw Studs 3/8" #333105 (p.169)
- 20 SnapRite® Pull-The-DOT® Snap Buttons 1/4" Barrel #104299 (p.179)
- 20 Pull-The-DOT® Snap Sockets #555050 (p.179)
- 40 DOT® Snap Fastener & Pull-the-DOT® Eyelets 1/4" #333555 (p.179)
- 10 Pull-The-DOT® Snap Screw Studs 3/8" #555105 (p.179)
- 10 Pull-The-DOT® Snap Cloth-to-Cloth Studs #555100 (p.179)
- 20 SnapRite® Gypsy Studs 3/16" Barrel #104236 (p.169)
- 30 Snap Fastener Cloth-to-Cloth Standard Studs #333100 (p.169)

#104438 \$45.85 KIT



## SNAPRITE® TWIST-LOCK STUD DIE

Install twist-lock fasteners to canvas quickly and easily using a rivet tool. Kits include the Spin Cut tool and a cutting block so a hole can easily be pre-cut in the fabric without needing a hard surface or a mallet. With this system, the entire installation of twist-lock fasteners can be done without a workbench, making it ideal for use on a boat. Works with any standard rivet tool. Made in the USA.



**Kit Includes:** SnapRite Twist-Lock Stud Die #104477 (p.172), Stayput Spin Cut 1/8" #104482 (p.197), 5"x5" Premium Cutting Block #103651 (p.197), SnapRite Button Die #104229 (p.172), SnapRite Mandrels (100 pk.) #103813 (p.172)

Kit #104619 \$81.40 KIT  
Die only #104477 \$21.90 EA



## LIFT-THE-DOT® FASTENERS

Nickel-plated brass fasteners that only open easily when lifted from one side. Unlikely to come undone when peeled from the other side. Available in cloth-to-cloth and cloth-to-surface configurations. Often used to secure boat covers and dodgers.

### CLOTH-TO-CLOTH (C-C)

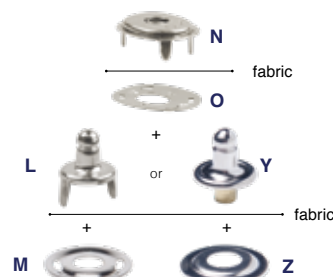

### CLOTH-TO-SURFACE (C-S)

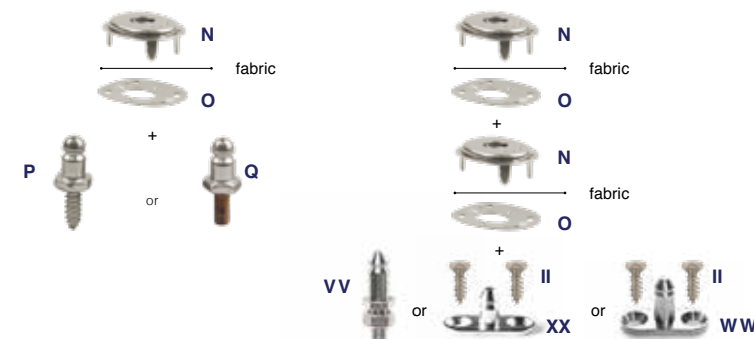

COMPLETE SETS**		C-C	C-S	PART #	1-9 PK	10-99 PK	100+ PK
Lift-The-Dot Cloth-to-Surface (3 pc.) (N <sup>3</sup> , O, P)			•	#888200	\$12.65 PK10	\$10.75 PK10	\$10.12 PK10
Lift-The-Dot Cloth-to-Cloth (4 pc.) (N <sup>3</sup> , O, L, M)		•		#888100	\$12.20 PK10	\$10.37 PK10	\$9.76 PK10
KEY	COMPONENTS (NICKEL-PLATED)	C-C	C-S	PART #	1-9 PK	10-99 PK	100+ PK
L	2 Prong Stud	•		#888005	\$3.95 PK10	\$3.56 PK10	\$3.36 PK10
M	Washer	•		#888010	\$1.55 PK10	\$1.40 PK10	\$1.32 PK10
N <sup>3</sup>	Socket	•	•	#888015	\$4.95 PK10	\$4.46 PK10	\$4.21 PK10
N <sup>2</sup>	Socket (Extended Legs)	•	•	#888017	\$5.95 PK10	\$5.36 PK10	\$5.06 PK10
O	Backplate	•	•	#888020	\$1.75 PK10	\$1.58 PK10	\$1.49 PK10
P	1/2" Screw Stud (8-18 Self-Tap)		•	#888025	\$5.95 PK10	\$5.36 PK10	\$5.06 PK10
Q	3/8" Machine Screw Stud (8-32)		•	#888030	\$3.95 PK10	\$3.56 PK10	\$3.36 PK10
Q	5/8" Machine Screw Stud (8-32)		•	#888035	\$3.95 PK10	\$3.56 PK10	\$3.36 PK10
Y <sup>1</sup>	Eyelet-Type Base Stud*	•		#888050	\$3.95 PK10	\$3.56 PK10	\$3.36 PK10
Y <sup>2</sup>	Long Eyelet-Type Base Stud*	•		#888055	\$3.95 PK10	\$3.56 PK10	\$3.36 PK10
Z	Eyelet-type Base Washer*	•		#888060	\$1.20 PK10	\$1.08 PK10	\$1.02 PK10
VV	Double Height Machine Screw Stud (thread size: M5 x 10mm)		•	#888075	\$14.95 PK10	\$13.46 PK10	\$12.71 PK10
XX <sup>4</sup>	Standard Height Stud Two Hole Base		•	#888065	\$16.95 PK10	\$15.26 PK10	\$14.41 PK10
WW <sup>4</sup>	Double Height Stud Two Hole Base		•	#888070	\$21.95 PK10	\$19.76 PK10	\$18.66 PK10
II	Screw Flat Head 6 x 1/2" (2 Required)		••	#777040	\$2.00 PK10	\$1.80 PK10	\$1.70 PK10

<sup>1</sup> Use for up to 1/8" assemblies (up to 6 layers of canvas)

<sup>2</sup> Use for up to 11/64" assemblies (up to 8 layers of canvas)

<sup>3</sup> Use for up to 3/32" assemblies (up to 5 layers of canvas)

<sup>4</sup> 23/32" between holes

\* Installation requires the Pres-N-Snap tool and Lift-The-Dot Eyelet-Type Base Die Set #106397 (p.175)

\*\* Complete sets come with standard socket leg length

## SNAPRITE DIES à la carte



**SNAPRITE® BUTTON DIE**  
Use with: Socket Die  
Die Position: Top, rivet tool nosepiece  
Installs: SRR, SRA, SRG  
#104229 \$24.05 EA



**SNAPRITE® EYELET DIE**  
Use with: Stud Die  
Die Position: Base, rests on hard surface  
Installs: D, SSD  
#104226 \$12.45 EA



**SNAPRITE® SOCKET DIE**  
Use with: Button or Stud Die  
Die Position: Base, rests on hard surface or snaps to installed stud (making it a precise positioning tool!)  
Installs: B, SSB, S  
#104232 \$23.15 EA



**SNAPRITE® STUD DIE**  
Use with: Socket or Eyelet Die  
Die Position: Top, rivet tool nosepiece  
Installs: C, SSC, T, SRJ  
#104235 \$25.35 EA



**STAINLESS STEEL MANDRELS**  
Use with SnapRite dies to install fastener components.  
#103813  
1-9 \$8.50 PK100  
10+ \$7.65 PK100

### A LIFT-THE-DOT® HAND PUNCH

Cut slits for cloth-to-cloth Common Sense and Lift-The-Dot prong studs. Cuts slits for L and CC. #100972 \$22.95 EA

### B LIFT-THE-DOT® HOLE CUTTER

Cut the center hole and 4 small slits for Lift-the-Dot sockets with help from a mallet. Quick and easy to use. Cuts holes for N, U. #110012 \$63.95 EA

### C RUBBER CUTTING BLOCK

Keep cutting tools sharp! Made from recycled rubber by a local Indiana company. 10" x 10" x 3/8". #378100 \$17.95 EA

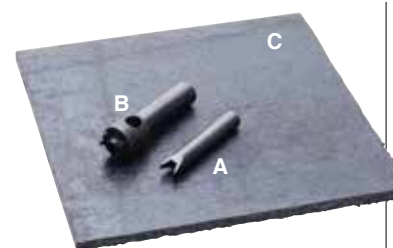

## LIFT-THE-DOT DELUXE LEVER HAND PUNCH TOOL

Save time installing Lift-The-DOT fasteners! This professional tool punches the center and prong holes for Lift-the-Dot sockets in one easy squeeze. Great for installing large numbers of Lift-the-DOT fasteners. Cuts through a maximum of 4 layers of Sunbrella (or equivalent thickness).

#100695 \$340.95 EA



**FASTENER TOOL SELECTION GUIDE** Determine what tools are needed to install each fastener. p.248



## SNAP FASTENER STARTER KIT

260 nickel-plated brass snap components for a variety of applications. Install cloth-to-cloth and cloth-to-surface snaps as well as Pull-The-Dot (one way) fasteners and gypsy studs. Great to use with the Pres-N-Snap installation tool.

### KIT INCLUDES:

- 20 DOT® Snap Fastener Buttons Silver 1/4" Barrel #333010 (p.169)
- 20 DOT® Snap Fastener Buttons Silver 11/64" Barrel #333777 (p.169)
- 40 Snap Fastener Normal Action Sockets #333050 (p.169)
- 20 DOT® Snap Fastener Hard Action Sockets #333058 (p.169)
- 10 DOT® Snap Fastener Screw Studs 3/8" #333105 (p.169)
- 20 Pull-The-DOT® Buttons #555777 (p.179)
- 20 Pull-The-DOT® Snap Sockets #555050 (p.179)
- 40 DOT® Snap Fastener & Pull-the-DOT® Eyelets 1/4" #333555 (p.179)
- 10 Pull-The-DOT® Snap Screw Studs 3/8" #555105 (p.179)
- 10 Pull-The-DOT® Snap Cloth-to-Cloth Studs #555100 (p.179)
- 30 Snap Fastener Cloth-to-Cloth Standard Studs #333100 (p.169)
- 20 DOT® Snap Fastener Gypsy Studs 3/16" Barrel #333130 (p.169)

#104800 \$43.75 KIT



### QUICK-FIT KIT

Position and reposition a cloth-to-surface snap to achieve the perfect fit! Install male stud with screw. Snap special female socket with pin head onto male stud and pull fabric into position. Poke pin head through fabric and place plastic holding cap over pin. Lift and reposition fabric over pin multiple times without damaging fabric. Reusable. Use to position A, SRA, SSA, SRG, B, and SSB.

Also great when used with the SnapRite System which acts like an additional Fit Pin Socket.

**KIT INCLUDES:** 20 fit pins, 20 holding caps, 1 release tool, and waterproof storage case (colors vary).

Quick Fit Kit #102565 \$63.50 KIT

Q Holding Cap #102007 1-19 \$3.95 PK5 | 20+ 3.56/PK5

R Fit Pin Socket #102009 1-19 \$8.95 PK5 | 20+ 8.06/PK5

S Release Tool #102011 \$4.95 EA

T Small Waterproof Box #102564 \$10.95 EA

### EXTEND-A-SNAP

Extend your reach between a snap stud and snap socket. Perfect for canvas covers that have shrunk in size. 3/4" extension. Leather with Ligne 24 nickel-plated brass snap. #103758

1-19 \$4.95 PK5

20+ \$4.46 PK5



## Install Twist Lock & Lift-The-Dot Fasteners with Ease

### NEW Twist Lock Driver Installation Tool

Easily install twist lock screw studs with this specialty screwdriver. The head perfectly fits a single twist lock fastener inside for manual setting. Comfortable handle is large enough to easily grip and the fluted handle design keeps the tool from rolling away.

#120751 \$19.95 EA



### Prong Bending Tool

This tool has a concave end that securely holds the metal prong on the back of fasteners and helps you bend them over the backing places. Bending is quick and easy with no slipping!

#120445 \$11.95 EA

See this tool in action installing a variety of fasteners at [Sailrite.com](http://Sailrite.com).



## PRES-N-SNAP INSTALLATION TOOL

The professional's tool for quick and easy snap fastener installation! Durable, easy to use, quick, and accurate. A one-handed squeeze automatically punches a hole in all weights of fabric and allows you to keep a hold on the fabric. The Pres-N-Snap tool comes with six dies for standard snap fastener (buttons, sockets, studs, and eyelets) and #1 plain washer grommets installation.

Pres-N-Snap Tool (w/6 dies - A, B, C, D, E) #109011 \$139.00 EA  
Replacement Original Die Set (6 pc. - A, B, C, D, E) #126311 \$99.95 EA



### PRES-N-SNAP BENCH MOUNT

Can be mounted either vertically or horizontally on a work bench.

#831123 \$32.95 EA

\* #2 Spur Grommets Die is not available and #2 Spur Grommets cannot be installed with #2 Plain Grommet Die.

# COMMON SENSE® / TWIST-LOCK FASTENERS

Nickel-plated brass Common Sense "twist-lock" fasteners are a quick and secure way to fasten cloth-to-cloth and cloth-to-surface applications. Often used to hold covers and enclosures in place. Designed specifically for wet environments. All complete sets include an eyelet, stud, and all necessary backing plates.

Use a 2 screw stud (flat base) with buttons on cloth-to-cloth applications to add a more finished appearance to the back of the stud. Buttons are very strong and eliminate any possibility of chafe. The Snap Fastener Installation Tool (#25204), SnapRite Twist Lock Die Kit (#104619), Deluxe Snap Fastener Anvil (#100949), or Pres-N-Snap Tool (#109011) with the Turn Lock Die Set (#104993) is required for installation. The studs used for cloth-to-surface installation screw into any hard surface. Use the Single Screw Common Sense Driver Tool (#100135) with the 5/8" screw stud for easier installation.

## NICKEL-PLATED BRASS

CLOTH-TO-CLOTH (C-C)		CLOTH-TO-SURFACE (C-S)	
	OR		+
	OR		+

CLOTH-TO-CLOTH-TO-CLOTH (C-C-C)		CLOTH-TO-CLOTH-TO-SURFACE (C-C-S)	
	OR		+
	OR		+

FASTENER TOOL SELECTION GUIDE | Determine what tools are needed to install each fastener. p.248

Common Sense® is a registered Trademark of Scovill Fasteners, Inc. (DOT®).

COMPLETE SETS*	C-C	C-S	PART #	1-9 PK	10-99 PK	100+ PK
DOT® 2 Prong Stud Set (4 pc.) - Nickel-plated Brass AA <sup>1</sup> , BB, CC, DD	•		#777100	\$9.95 PK10	\$8.46 PK10	\$7.96 PK10
DOT® 2 Button Back Set (5 pc.) - Nickel-plated Brass AA <sup>1</sup> , BB, FF <sup>4</sup> , SRA (2)	•		#777200	\$13.25 PK10	\$11.26 PK10	\$10.60 PK10
DOT® Button Back Set (5 pc.) - Nickel-plated Brass AA <sup>1</sup> , BB, FF <sup>4</sup> , A (2)	•		#777800	\$12.25 PK10	\$10.41 PK10	\$9.80 PK10
DOT® 5/8" Screw Stud Set (3 pc.) - Nickel-plated Brass AA <sup>1</sup> , BB, EE		•	#777300	\$12.35 PK10	\$10.50 PK10	\$9.88 PK10
DOT® 2 Screw Stud Set (5 pc.) - Nickel-plated Brass AA <sup>1</sup> , BB, FF <sup>4</sup> , II (2)		•	#777400	\$13.35 PK10	\$11.35 PK10	\$10.68 PK10
2 Screw Stud Set (5 pc) - Stainless Steel (not DOT® brand) SSG, SSI, SSH, II (2)		•	#777500	\$25.50 PK10	\$21.68 PK10	\$20.40 PK10
2 Button Back Set (5 pc) - Stainless Steel (not DOT® brand) SSG, SSI, SSH <sup>3</sup> , SSA <sup>1</sup> (2)	•		#777600	\$24.90 PK10	\$21.17 PK10	\$19.92 PK10

KEY	COMPONENTS (NICKEL-PLATED)	C-C	C-S	C-C-C	C-C-S	PART #	1-9 PK	10+ PK	100+ PK
A	Silver Button, 11/64" Barrel (2 required)	••		••		#333777	\$1.45 PK10	\$1.30 PK10	\$1.23 PK10
AA <sup>1</sup>	Eyelet	•	•	•	••	#777005	\$1.65 PK10	\$1.48 PK10	\$1.40 PK10
AA <sup>2</sup>	Long Prong Eyelet	•	•	•	••	#777006	\$1.95 PK10	\$1.76 PK10	\$1.66 PK10
BB	Washer	•	•	•	••	#777010	\$0.75 PK10	\$0.68 PK10	\$0.64 PK10
CC	2 Prong Stud	•				#777015	\$6.95 PK10	\$6.26 PK10	\$5.91 PK10
DD	Clinch Plate	•				#777020	\$0.60 PK10	\$0.54 PK10	\$0.51 PK10
EE	5/8" Screw Stud		•			#777025	\$9.95 PK10	\$8.96 PK10	\$8.46 PK10
FF <sup>3</sup>	2 Screw 1/4" Stud	•	•			#777030	\$6.95 PK10	\$6.26 PK10	\$5.91 PK10
GG <sup>3</sup>	Double Height 2 Screw 3/8" Stud <sup>3</sup>			•	•	#777035	\$6.95 PK10	\$6.26 PK10	\$5.91 PK10
SRA	SnapRite Silver Button, 11/64" Barrel (2 Required)	••		••		#104151	\$1.95 PK10	\$1.76 PK10	\$1.66 PK10
II	1/2" Screw (2 Required)		••		••	#777040	\$2.00 PK10	\$1.80 PK10	\$1.70 PK10
JJ	Oversized Washer	•	•	••	••	#777045	\$1.30 PK10	\$1.17 PK10	\$1.11 PK10
KK	Plastic Reinforced Washer	•	•	••	••	#777050	\$1.00 PK10	\$0.90 PK10	\$0.85 PK10
W <sup>1</sup>	Barrel Stud	•				#104803	\$11.95 PK10	\$10.75 PK10	\$10.16 PK10
X	Back Plate For Barrel Stud	•				#104804	\$1.10 PK10	\$0.99 PK10	\$0.94 PK10

KEY	COMPONENTS (STAINLESS STEEL)	C-C	C-S	PART #	1-9 PK	10+ PK	100+ PK
SSG	Eyelet	•	•	-	-	-	-
SSH <sup>3</sup>	2-Hole Base Stud	•	•	-	-	-	-
SSI	Clinch Plate	•	•	-	-	-	-
SSA <sup>1</sup>	Silver Button, 11/64" Barrel	••		#444777	\$1.70 PK10	\$1.53 PK10	\$1.44 PK10
II	1/2" Screw (2 Required)		••	#777040	\$2.00 PK10	\$1.80 PK10	\$1.70 PK10

<sup>1</sup> Use for up to 3/32" assemblies (up to 5 layers of canvas)

<sup>2</sup> 7/8" between holes

• = Add one •• = Add two

<sup>3</sup> Use for 9/64"-3/16" assemblies (6-9 layers of canvas)

\*Complete sets always come with the shortest pronged eyelet

## STAINLESS STEEL

(Only sold in kits #777500 and #777600. Not sold individually)

CLOTH-TO-CLOTH (C-C)		CLOTH-TO-SURFACE (C-S)	
	OR		+
	OR		+

## FASTENER TOOL SELECTION GUIDE

Determine what tools are needed to install each fastener. p.248

## A TYLASKA DUAL CAVITY SNAP FASTENER INSTALLATION DIE

Tough 4140 chrome-moly steel die that makes installing Common Sense fasteners or single snap fasteners easy and accurate. Precisely-spaced dual cavities allow two buttons or two eyelets to be set at one time to eliminate the uneven or creased settings caused by installing each component individually. Heavy weight, wide profile ensures a straight, clean installation. Use with a rivet punch (Snap Fastener Deluxe Installation Tool p.167).

#103543 \$34.95 EA

## B COMMON SENSE EYELET HOLE CUTTER

Use with a mallet to cut four slits and center hole for Common Sense eyelets. Great for installing multiple eyelets. Cuts hole for AA, SSG.

#108001 \$68.95 EA

## C COMMON SENSE STUD SINGLE SCREW DRIVER

Fits just like a drill bit into your drill and quickly drives in cloth-to-surface Common Sense single screw studs. Pre-drill a small hole before use. Use with EE.

#100135 \$34.95 EA



## D COMMON SENSE HAND PUNCH

Cut slits for cloth-to-cloth Common Sense prong studs and Lift-The-Dot studs. Cuts slits for L & CC.

#100972 \$22.95 EA

## E RUBBER CUTTING BLOCK

Keep cutting tools sharp! Made from recycled rubber by a local Indiana company. 10" x 10" x 3/8".





#378100 \$17.95 EA

## NEW LOXX® PULL IT UP FASTENERS

Cleverly engineered, self-locking snap fasteners that cannot come undone once engaged. Releases instantly by pulling up on the head of the button component. The positive engagement and locking feature is great for applications where security, low profile, and performance are minimum prerequisites.

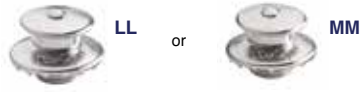
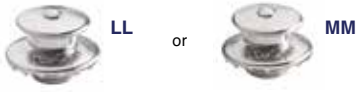
Nickel-plated brass fasteners available in a variety of stud styles including screw studs, two hole plate studs, and machine screw studs. Ideal choice for marine, leather, and automotive applications. Locking Key required for installation.

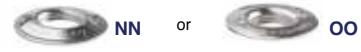
Note: Loxx Pull It Up Fasteners are compatible with Tenax Pull It Up fasteners previously sold by Sailrite.

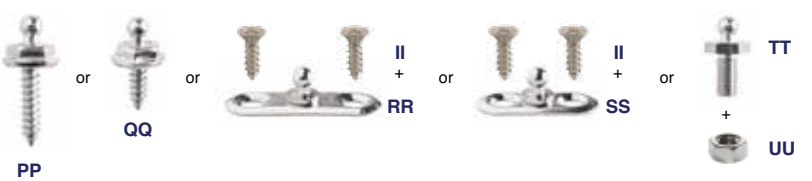
CLOTH-TO-CLOTH (C-C)	CLOTH-TO-SURFACE (C-S)
 LL or MM	 LL or MM
 (LL) or (MM)	 (LL) or (MM)
 NN or OO	 NN or OO
 (NN) or (OO)	 PP, QQ, RR, SS, TT, UU

## PULL-THE-DOT® (ONE WAY) FASTENERS

Uniquely designed three-sided built-in locking snap fastener that can withstand extreme pressure on three sides without unlocking. Releases instantly with pressure on the fourth side. Well suited for applications where the strain on the snap is not shear, as on the front panel of a dodger. Top quality nickel plated brass with bronze springs (surface studs have stainless steel screws). Highly resistant to corrosion.

**INSTALLATION:** Rivet or screw the stud in place as normal but install the socket so the protrusion is on the side that is to be released easily. Pull from the protrusion side to open. Close the snap by closing the lip side first and then the protrusion side. The protrusion will also prevent the snap from turning after installation. Install with the SnapRite System (#104500, p.171) using the SnapRite button or the Pres-N-Snap Tool (additional die required, #109011, p.175).

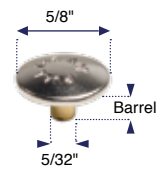

CLOTH-TO-CLOTH (C-C)	CLOTH-TO-SURFACE (C-S)
 SRR or R	 SRR or R
 S	 S
 T	 V
 D	

## LOXX® PULL IT UP FASTENERS

COMPLETE SETS	C-C	C-S	PART #	1-19 PK	20+ PK
NEW Loxx® Fastener Cloth-to-Cloth (2 PC) LL, NN	•		#121361	\$24.65 PK5	\$22.19 PK5
NEW Loxx® Fastener Cloth-to-Cloth Set for Thick Assemblies (2 PC) MM, OO	•		#121363	\$24.65 PK5	\$22.19 PK5
NEW Loxx® Fastener Cloth-to-Surface Screw Stud Set (2 PC) LL, QQ		•	#121362	\$22.75 PK5	\$20.48 PK5
NEW Loxx® Fastener Cloth-to-Surface Oval Plate Stud Set (4 PC) LL, SS, II (2)		•	#121364	\$24.65 PK5	\$22.18 PK5
NEW Loxx® Fastener Cloth-to-Surface Set for Thick Assemblies (4 PC) MM, SS, II (2)		•	#121365	\$24.65 PK5	\$22.18 PK5

KEY	COMPONENTS (Nickel-Plated)	C-C	C-S	PART #	1-19 PK	20+ PK
LL <sup>1</sup>	NEW Upper Head with Regular Washer	•	•	#121356	\$15.95 PK5	\$14.36 PK5
MM <sup>2</sup>	NEW Upper Head with Long Washer (For Thick Assemblies)	•	•	#121355	\$15.95 PK5	\$14.36 PK5
NN <sup>1</sup>	NEW Lower Stud with Regular Washer	•		#121349	\$9.95 PK5	\$8.96 PK5
OO <sup>2</sup>	NEW Lower Stud with Long Washer (For Thick Assemblies)	•		#121348	\$9.95 PK5	\$8.96 PK5
PP	NEW 5/8" Self-Tapping Screw Stud		•	#121353	\$8.95 PK5	\$8.06 PK5
QQ	NEW 1/2" Self-Tapping Screw Stud		•	#121354	\$7.95 PK5	\$7.16 PK5
RR	NEW 1-3/8" Oval Plate Stud		•	#121350	\$8.95 PK5	\$8.06 PK5
SS	NEW 1" Oval Plate Stud		•	#121351	\$7.95 PK5	\$7.16 PK5
TT	NEW 3/8" Machine Screw Stud		•	#121352	\$8.95 PK5	\$8.06 PK5
UU	NEW Nut Stainless Steel (Not Loxx® Brand)		•	#121360	\$0.70 PK5	\$0.63 PK5

KEY	COMPONENTS (Stainless Steel)	C-C	C-S	C-C-S	PART #	1-9 PK	10-99 PK	100+ PK
II	6 x 1/2" Screw (2 required per fastener) (Not Loxx® Brand)		••		#777040	\$2.00 PK10	\$1.80 PK10	\$1.70 PK10

<sup>1</sup> Use for 0.065" – 0.125" (1.65mm – 3.18mm) assemblies (3-6 layers of canvas)

<sup>2</sup> Use for up to 0.087" – 0.174" (2.22 – 4.44mm) assemblies (4-8 layers of canvas)

• = Add one •• = Add two

## PULL-THE-DOT (ONE-WAY) FASTENERS

KEY	COMPONENTS (NICKEL-PLATED)	C-C	C-S	PART #	1-9 PK	10-99 PK	100+ PK
R	Silver Button, 11/64" Barrel	•	•	#555777	\$2.95 PK10	\$2.66 PK10	\$2.51 PK10
SRR	SnapRite Silver Button, 1/4" Barrel	•	•	#104299	\$2.95 PK10	\$2.66 PK10	\$2.51 PK10
S	Socket	•	•	#555050	\$2.95 PK10	\$2.66 PK10	\$2.51 PK10
T	Stud	•		#555100	\$1.70 PK10	\$1.53 PK10	\$1.44 PK10
D	Eyelet, 1/4" Barrel	•		#333555	\$0.70 PK10	\$0.63 PK10	\$0.59 PK10
V	3/8" Screw Stud (8-15 Self-Tap)		•	#555105	\$4.95 PK10	\$4.46 PK10	\$4.21 PK10

FASTENER TOOL SELECTION GUIDE | Determine what tools are needed to install each fastener. p.248



**NEW LOXX PULL IT UP FASTENER LOCKING TOOL**  
Tighten Pull It Up fasteners more easily with this locking tool with a comfortable-to-hold wooden handle. Installs LL, MM, NN and OO.  
#121358 \$13.95 EA

**#2 (3/8") HOLE CUTTER**  
Hole cutter details on p.197. Use to cut holes for LL, MM, NN and OO.  
#18211 \$25.95 EA



# SHOCK CORD ACCESSORIES

## SHOCK CORD COVER CLIPS & LACING KNOBS

Hold down mooring, tonneau, RV & boat covers, dodgers, and curtains quickly and securely. Screw lacing knob into hard surface (screw required). Cut small hole in the fabric (#18209, p.197) and snap self-locking cover clips together.

**G WHITE COVER CLIP**  
(Overall relaxed length: 3.5 inches)  
#100368 \$10.95 PK5

**LARGE WHITE COVER CLIP**  
(Overall relaxed length: 4 inches)  
#107117 \$12.95 PK5

**WHITE LACING KNOB #100370 \$2.95 PK5**

**H BLACK COVER CLIP**  
(Overall relaxed length: 3.5 inches)  
#100369 \$10.95 PK5

**LARGE BLACK COVER CLIP**  
(Overall relaxed length: 4.25 inches)  
#107118 \$12.95 PK5

**I BLACK LACING KNOB #100371 \$2.95 PK5**

## STAYPUT LASHING HOOK

Smooth rounded hook (no sharp edges) with narrow opening to allow rope or cord to snap securely into position. Use with countersunk screws (#1408, sold separately).

White #103238 \$4.95 PK5

J Black #103239 \$4.95 PK5

## SHOCK CORD HOOKS

Safe on finished or plated surfaces.

**K Self-locking, Black, 3/16"-1/4" cord**  
#369011 \$2.95 PK10

**L Self-locking, Black, 1/4"-5/16" cord**  
#370011 \$6.95 PK10

**M Tie-off, White, 3/16"-5/16" cord**  
#29307 \$2.95 PK10

**N Tie-off, White, 1/4" cord**  
#29308 \$12.95 PK5

**O Cleat, Black, 3/16"-5/16" cord**  
#100297 \$5.95 PK5

## YKK® BARREL LOCK CLOSURES

The strongest barrels available! Close bags securely without tying. Squeeze together to slip cord through or move along cord. Release to lock cord in place. Non-metal push gate locks cords in place. Polyacetal. Black.

**P 5/32" #270011 \$1.95 PK5**

**Q 5/32" with Side Slots #103973 \$1.95 PK5**

**R 1/4" (Not YKK®) #102552 \$0.95 PK5**

**S 3/16" #104424 \$1.95 PK5**

**T 3/16" Doubled #104423 \$1.95 PK5**

**U Double Barrel Lock (Up to 3/16" line)**  
#102551 \$1.95 PK5

## BUY MORE, SAVE MORE!

Quantity pricing available at Sailrite.com

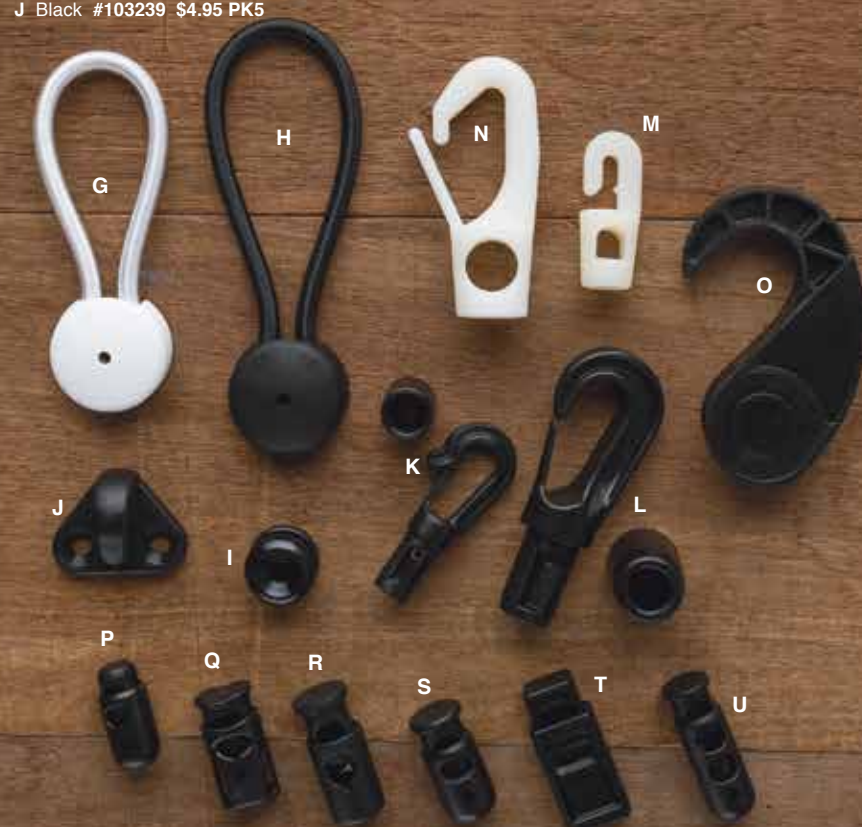

## PERMALOCK NON-METAL FASTENERS

Durable, non-metal twist-lock fasteners. Secure stud with backplate and rivets or screws. Squeeze eyelet together by hand. Cut hole with hot knife or scissors. Non-corrosive, UV stabilized Zytel. Dimensions at Sailrite.com.

### CLOTH-TO-CLOTH

Includes rivets. Requires Snap Fastener Installation Tool (#25204) or Deluxe Snap Fastener Installation Anvil (#100949)

**A White #102584 \$13.50 PK5**

**Black #102585 \$13.50 PK5**

### CLOTH-TO-SURFACE

Includes screw base and 2 flat-head screws.

**White #102586 \$11.50 PK5**

**B Black #102587 \$11.50 PK5**

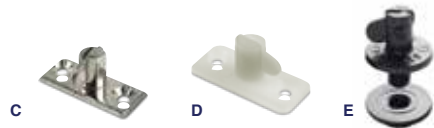

## STAYPUT FASTENERS

Versatile grommet fastening system for attaching fabric to a solid or fabric surface. Ideal for securing covers or tarps that already have #1 spur or #2 plain grommets (with an inner diameter between 5/16" and 3/8") installed. Nylon or stainless steel. Dimensions at Sailrite.com

COLOR	PART #	1-19 PK	20+ PK
White	#103242	\$4.95 PK5	\$4.46 PK5
Black	#103243	\$4.95 PK5	\$4.46 PK5
C Stainless Steel	#103244	\$30.00 PK5	\$28.50 PK5

## VERTICAL MOUNT

D White	#103240	\$4.95 PK5	\$4.46 PK5
Black	#103241	\$4.95 PK5	\$4.46 PK5
C Stainless Steel	#103245	\$30.00 PK5	\$28.50 PK5

## CLOTH-TO-CLOTH

E White	#103246	\$5.95 PK5	\$5.36 PK5
Black	#103247	\$5.95 PK5	\$5.36 PK5



## EASY INSTALL PLASTIC TURN FASTENERS

Quick and easy way to secure fabric together like canvas flaps, small covers, and bags and other light duty applications. Non-corrosive fasteners lock tight. Install eyelet using #3 hole cutter or razor blade. Install stud using 1/8" hole cutter. Press the fasteners in place. Maximum 3 layers of Sunbrella canvas. Includes eyelet with backing plate and stud with backing plate. Black polyacetal. Dimensions at sailrite.com.

PART #	1-9 PK	10-99 PK	100+
#102556	\$2.95 PK10	\$2.66 PK10	\$2.51 PK10

# YKK® SNAD® ADHESIVE-BACKED FASTENERS

Secure marine attachment without damaging your surface! Fastener attaches with a 3M™ VHB™ acrylic conformable foam adhesive tape making misplacements easy to correct. Fastener will not deteriorate from exposure to sunlight, sand or dirt. Use wherever a conventional screw stud or socket might be used like marine carpeting, cushions, seating, and canvas covers. **Compatible with DOT® Durable Ligne 24 snap fasteners.**



## FLEXIBLE BASE SNAD® FASTENERS

Stainless steel stud with flexible silicone body. Perfect for installing a fastener on curved or uneven surfaces like bimini and dodger frame tubing. Available in 25mm or 40mm diameter. Select 40mm for best strength. Overall Height: 5/16".

- A Gray 25mm Stud #103596 \$8.95 PK5**
- B White 25mm Stud #103652 \$8.95 PK5**
- C Black 25mm Stud #103649 \$8.95 PK5**
- D Clear 25mm Stud #104451 \$8.95 PK5**
- E White 40mm Stud #104453 \$15.95 PK5**
- F Clear 40mm Stud #104452 \$15.95 PK5**
- G Clear 25mm Base Socket #105029 \$9.95 PK5**

## DOMED SNAD® FASTENERS

Plastic domed fastener will not snag clothing and can be walked over without causing pain. Diameter: 1.57". Overall Height: 1/4".

- H White Stud #103354 \$6.95 PK5**
- I White Socket #103348 \$6.95 PK5**
- J Black Stud #103587 \$6.95 PK5**
- K Black Socket #103579 \$6.95 PK5**

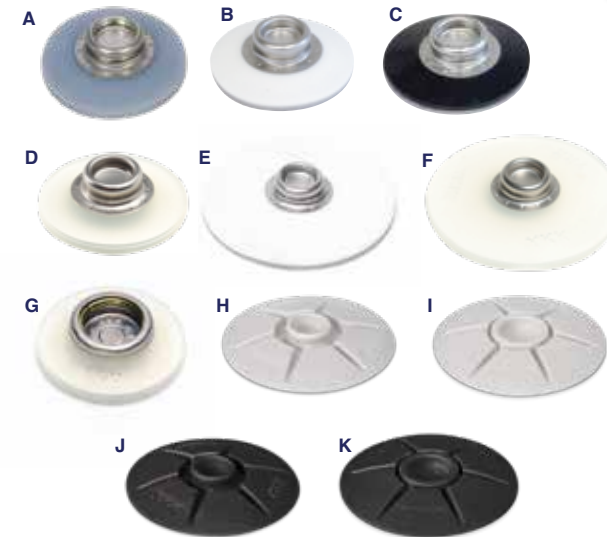

## 3M SILANE GLASS TREATMENT

Helps 3M adhesive stick and stay on uncoated glass surfaces! Prevent water from interfering with the bond of your adhesive. This treatment makes glass hydrophobic to repel water from the adhesion area. Best if used within 90 days. 4 ounce spray bottle.

#120678 \$10.95 EA

## 3M TAPE PRIMER 94 - ADHESIVE PROMOTER

p.163



## FREE VIDEO: "How to Improve the Holding Strength of YKK SNADS"

Watch at Sailrite.com (#X-HT-300116)

# WEBBING SLIDERS



## YKK® LOOP LOC

Hold loose pieces of webbing in place to avoid flapping or whipping. Durable black Delrin. Inside height: 5/16".

- 3/4" webbing #104425 \$0.95 PK5
- 1" webbing #104426 \$1.00 PK5
- 1-1/2" webbing #104427 \$0.95 PK5
- 2" webbing #104428 \$2.95 PK5

## YKK® TRI-BAR ADJUSTABLE WEBBING SLIDERS

Secure loose webbing and provide adjustment for straps. Locking teeth on both the side and middle bars prevents slippage. Durable polyacetal. Black.

- 3/4" webbing #104419 \$0.95 PK5
- 1" webbing #104420 \$0.95 PK5
- 1-1/2" webbing #104421 \$1.95 PK5
- 2" webbing #104422 \$1.95 PK5

## WEBBING SLIDERS

Use to adjust webbing strap length. Center bar. Stainless steel.

- 1" webbing #28207 \$1.30 EA
- 1" webbing, Suncor (WL: 150 lb.) #103781 \$1.95 EA
- 1-1/2" webbing, Suncor (WL: 200 lb.) #103780 \$1.95 EA
- 2" webbing, Suncor (WL: 250 lb.) #103779 \$2.95 EA

## SHOULDER PAD

Great for finished shoulder straps. Slide 1" webbing through pad. Black elastomer. Length: 5-1/2".

#99509 \$1.65 PK5



## SUNCOR ADJUSTABLE WEBBING SLIDERS

Easily adjust compression battens, secure dodger frames or attach awnings with this buckle. Molded teeth and increased contours prevent webbing creep and slippage. Polyacetal. Black.

- 1" webbing #103777 \$3.95 EA
- 2" webbing #103778 \$7.95 EA

## YKK® ADJUSTABLE STRAP BUCKLES

Easily adjust compression battens, secure dodger frames or attach awnings with this buckle. Molded teeth and increased contours prevent webbing creep and slippage. Polyacetal. Black.

- 3/4" webbing #104410 \$0.95 PK5
- 1" webbing #104411 \$0.95 PK5

## YKK® LADDERLOCK BUCKLE

Use for compression battens, awning attachments, or dodger frames. Molded teeth and contour prevent webbing creep or slippage. Nylon. Black. 1" webbing.

#84107 \$0.95 PK5

## SUNCOR STAR WEBBING ADJUSTER

Heavy-duty precision-cast 316 stainless steel 1" webbing adjuster with teeth to grip webbing. Round recess accepts hook or clip. Working load: 500 lb.

#103776 \$12.95 EA

## YKK® ADJUSTABLE STRAP BUCKLE

Easily adjust compression battens, secure dodger frames or attach awnings with this buckle. Molded teeth and increased contours prevent webbing creep and slippage. Polyacetal. Black. 1-1/2" webbing.

#120695 \$0.95 PK5



## BEAUCLIP PANEL MOUNTING SYSTEM

The BeauClip Panel Mounting System is a simple and durable fastener solution for hanging panels accurately and securely in place to solid surfaces. No need for complicated measurements or specialty tools as this system is designed for easy installation. After installation, the BeauClip securely snaps into place and holds up to 15 pounds per clip. Use the BeauClip Panel Mounting System for installing hard panels, upholstered panels, headboards, headliner/hull liner panels, access panels in boats & RVs, architectural woodwork, acoustic upholstered wall panels, seat cushions, coaming pads, and so much more! Requires #4 flat head screws for installation (8 per clip).

BeauClip Panel Mounting System Black **#107156**  
 1-9 **\$6.95 PK10** 10+ **\$6.17 PK10**  
 Screw Flat Head 18-8 Stainless Steel #4 x 3/8" **#120462 \$1.15 PK10**



Watch demo installation videos at **Sailrite.com**

## HOOKS



**FIXED EYE SNAP HOOK**  
 Designed to attach to rope or wire, this snap is made from precision cast, grade 316 stainless steel. Ideal for outdoor and marine applications. Spring action snap for easy installation.  
 3/8" Rope **#105434 \$3.95 EA**  
 5/8" Rope **#105435 \$4.95 EA**  
 3/4" Rope **#105436 \$5.95 EA**  
 7/8" Rope **#105437 \$7.95 EA**

**PLASTIC COVER HOOK & EYELET SET**  
 Great for securing small covers! Sew onto fabric edge. Hook and eyelet quickly snap together.  
 White **#102040 \$6.50 PK5**  
 Black **#102041 \$7.00 PK5**

**STAYPUT TENT WALL HOOK**  
 Designed to hang marquee or tent walls from rope or wire. Cut 1/4" hole in fabric and secure hook using back plug. Remove and refit without damaging fabric or hook. Installs with hole cutter and hammer. White. Nylon.  
**#103438 \$4.95 PK5**

**WIRE COVER HOOKS**  
 Hand sew hook along edge of cover with sail twine. Opposite hook, expose line in hem using two grommets exit points. Lace line through grommets to form a "hookable" loop. Hooks up to 5/16" line.  
**#321500 \$5.95 PK5**

**SUNCOR FOOTMAN'S LOOP**  
 Stainless steel low profile attachment point for webbing and straps. Working load: 400 lb.  
**1" Footman's Loop:** Use with Flat Webbing Hook (#103753). #8 screws sold separately (#100490). **#103797 \$4.95 EA**  
**2" Footman's loop:** Use with Flat Webbing Hook (#120527). #8 screws sold separately (#100490). **#120526 \$7.95 EA**

**STRAP EYE**  
 A mounting point for bimini, dodger, or awning webbing straps with snap hooks. Type 316 stainless steel. Screws sold separately.  
**#28221 \$1.20 EA**  
 Flat-head Screw (6 x 1/2") **#777040 \$2.00 PK10**

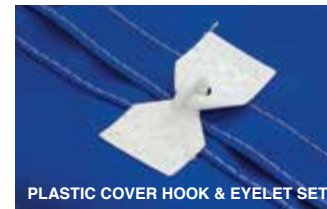
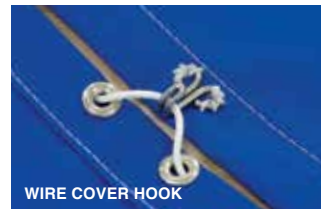

**SUNCOR STRAP EYE STAMPED STAINLESS STEEL**  
 A mounting point for bimini, dodger, or awning webbing straps with snap hooks. Type 304 stainless steel. Screws sold separately.  
**#120461 \$1.50 EA**  
 Pan Head Screw (6 X 3/4")  
**#100276 \$2.30 PK10**

**SUNCOR FLAT WEBBING HOOK**  
 Stainless steel hook designed to attach webbing to footman's loop or webbing shackle.  
**1" Hook:** Working load: 350 lb. Hook width: 0.919". Hook inside diameter: 0.313" **#103753 \$2.95 EA**  
**2" Hook:** Working load: 1,500 lb. Hook Width 1.7" Hook inside diameter: 0.625" **#120527 \$13.95 EA**

**FENDER/LIFELINE HOOK**  
 Also called a lacing hook. Bolt to gunnel to hang boat fenders or lifeline netting. Stainless steel. 1-1/4"W x 1"L. Counter sunk 3/16" screw holes. Screws sold separately (#777040).  
**D #100648 \$0.80 EA**

## CLIPS



**SNAP CLIPS**  
 Attach to line and snap onto webbing at top and bottom of flag. Nylon. Black. Hole size: 3/8". Thermoplastic.  
**#93825 \$2.80 PK10**

**SPRING SNAP**  
 Great for tote bag straps! Self-aligning swivel eliminates twisted webbing straps. Black acetel. Length: 2-7/16". 1" webbing.  
**#93819 \$3.50 PK10**

**SNAP HOOK**  
 Hook to mounted strap eye. Type 316 stainless steel. Length: 2-1/8". Opening: 5/16". 1" webbing.  
**#28206 \$1.20 EA**

**SUNCOR SWIVEL WEB CLIP**  
 Ideal for removable webbing straps. Swivel has durable torsion spring gate. Polished 304 stainless steel. Corrosion resistant. Length: 2-1/2". Opening: 5/8". Working load: 130 lb.  
 1" webbing **#103769 \$7.95 EA**  
 1-1/2" webbing **#103770 \$7.95 EA**  
 2" webbing **#103771 \$8.95 EA**



**SUNCOR POLY GRIP HARNESS CLIP**  
 Drop-forged, heavy-duty stainless steel harness clip with orange polyurethane grips for superior handling. Long-lasting torsion spring gate. Length: 4". Rope dia.: 1/2". Working load: 1,000 lb. Breaking load: 5,000 lb.  
**#103763 \$24.95 EA**

**SUNCOR SPRING CLIP**  
 High quality, drop-forged 316 stainless steel spring clip with wire lever. Long-lasting torsion spring gate. Length: 3". Opening 0.62". Working load: 700 lb.  
**#103744 \$16.95 EA**

**SUNCOR ASYMMETRICAL WIRE LEVER HARNESS CLIP**  
 Designed for marine rigging and safety applications. Stainless steel, forged end, and long-lasting torsion spring gate. Length: 4". Rope dia.: 5/8" Working load: 1,200 lb. Breaking load: 6,000 lb.  
**#103760 \$14.65 EA**

**FAST EYE SNAP HOOK**  
 Hook to mounted strap eye. Heavy-duty Type 316 stainless steel. Length: 2". Opening: 1/4". 1" webbing.  
**#100532 \$4.50 EA**

## BUCKLES & WEBBING HARDWARE



**YKK® SIDE RELEASE BUCKLES**  
 Used on life jackets, webbing belts, duffle bag straps, and boat covers. Side release prevents accidental opening while still easy to open with one hand. Heavy duty. Polyacetel.  
 Black, 3/4" webbing **#104243**  
 1-19 **\$1.95 PK5** 20+ **\$1.76 PK5**  
 Black, 1" webbing **#104322**  
 1-19 **\$1.95 PK5** 20+ **\$1.76 PK5**  
 Black, 1-1/2" webbing **#104323**  
 1-19 **\$3.95 PK5** 20+ **\$3.56 PK5**  
 Black, 2" webbing **#104324**  
 1-19 **\$4.95 PK5** 20+ **\$4.46 PK5**

**YKK® DOUBLE ADJUSTABLE SIDE RELEASE BUCKLES**  
 Adjust webbing from both sides of the buckle. Side release prevents unintentional opening but can be easily released with one hand. Ideal for safety harnesses and applications where the buckle is centered. Acetal. Black.  
 1" webbing **#102485**  
 1-19 **\$3.00 PK5** 20+ **\$2.70 PK5**  
 2" webbing **#919611**  
 1-19 **\$5.95 PK5** 20+ **\$5.36 PK5**

**YKK® CURVED SIDE RELEASE BUCKLES**  
 Gentle curve makes this buckle perfect for animal collars or paracord bracelets. Adjustable on one side. Polyacetel. Black.  
 5/8" webbing **#104242**  
 1-19 **\$1.95 PK5** 20+ **\$1.76 PK5**  
 3/4" webbing **#104240**  
 1-19 **\$1.95 PK5** 20+ **\$1.76 PK5**  
 1" webbing **#104241**  
 1-19 **\$1.95 PK5** 20+ **\$1.76 PK5**  
 1-1/2" webbing **#120656**  
 1-19 **\$5.95 PK5** 20+ **\$5.36 PK5**



**YKK® ROTARY CENTER RELEASE BUCKLES**  
 Pivots to secure webbing straps even at odd angles. Each side rotates up to a 45-degree angle. Center release. Adjustable on one side. Acetal. Black.  
 1" webbing **#104238**  
 1-19 **\$2.95 PK5** 20+ **\$2.66 PK5**

**YKK® D-RINGS**  
 Use at the end of webbing as an attachment point for snap hooks or other devices. Acetal. Black.  
 3/4" webbing **#104415**  
 1-9 **\$1.95 PK10** 10+ **\$1.76 PK10**  
 1" webbing **#104416**  
 1-9 **\$1.95 PK10** 10+ **\$1.76 PK10**  
 1-1/2" webbing **#104417**  
 1-9 **\$1.95 PK10** 10+ **\$1.76 PK10**  
 2" webbing **#104418**  
 1-9 **\$5.95 PK10** 10+ **\$5.36 PK10**

**YKK® SNAP HOOK SWIVEL**  
 Eliminate tangling and twisting of webbing straps. Self-aligning hook swivels and rotates. Great for tote bags, backpacks, camera bag straps, and more. Polyacetel. Black.  
 1" webbing **#104412**  
 1-19 **\$1.95 PK10** 20+ **\$1.76 PK10**  
 1-1/2" webbing **#104413**  
 1-19 **\$2.95 PK10** 20+ **\$2.66 PK10**  
 2" webbing **#104414**  
 1-19 **\$3.95 PK10** 20+ **\$3.56 PK10**

**CAM BUCKLES**  
 Adjust and secure 1" webbing straps and other light duty applications. Attach to canvas or webbing strap with webbing loop.  
 Black plastic **#100551**  
 1-19 **\$2.70 PK5** 20+ **\$2.43 PK5**  
 Stainless steel (Suncor, working: 100 lb.) **#103782 \$7.25 EA**

**BUY MORE, SAVE MORE!** Quantity pricing available at [Sailrite.com](http://Sailrite.com)



## AWNING TRACK

Easy to install and very handy for quick fabric attachment to a hard surface. Attach fabric to an awning rope and then slide through the track.

Corresponding Awning Rope can be found on p.223.

### 1 FLEX-A-RAIL TRACK

A PVC extrusion that is best for twisting around corners (steam heat if necessary). Cuts easily with hacksaw. Drill holes every 4–12" through the center of the track with at least one hole close to each end of the track. Secure with flat-head stainless steel screws (#440) and a Standard #0 Square Head Driver (#100345).

### 2 HEAVY DUTY FLANGED TRACK

A PVC extrusion with a flange along one edge for installation. Use anywhere a gentle bend or no bend is required. Install using 6 x 3/4" self-tapping pan head screws (#100276) every 4–12" with a screw close to each end.

### 3 ANODIZED ALUMINUM TRACK

Similar to the Heavy Duty Flanged track but stronger. Polished anodized aluminum. Bend only over a very large radius. Install on hard surfaces.

### 4 KEDER RAIL STRIP

A PVC extrusion that features a soft flange that can be sewn through with a sewing machine. Sew directly to fabric even if there is a gentle bend in your canvas project. Use with Keder awning rope (durable and runs smoothly) or vinyl awning rope (snug fit, better seal, difficult around corners).



TYPE	LENGTH	COLOR	A WIDTH	B HEIGHT	C INNER DIA.	D FLANGE	PART #	PRICE
Flex-A-Rail	44"	White	5/8"	5/8"	13/32"	-	#106100	\$6.95 EA
Flex-A-Rail	44"	Black	5/8"	5/8"	13/32"	-	#120147	\$6.95 EA
Flex-A-Rail	90"	White	5/8"	5/8"	13/32"	-	#103355	\$12.95 EA
Flex-A-Rail	90"	Black	5/8"	5/8"	13/32"	-	#120135	\$12.95 EA
HD Flanged	48"	White	1-5/16"	5/8"	13/32"	1/2"	#100380	\$10.20 EA
HD Flanged	96"	White	1-5/16"	5/8"	13/32"	1/2"	#103334	\$23.80 EA
Anodized Aluminum	47.5"	Silver	1-1/4"	1/2"	13/32"	3/4"	#141100	\$9.15 EA
Anodized Aluminum	95.75"	Silver	1-1/4"	1/2"	13/32"	3/4"	#103361	\$21.30 EA
Keder Rail Strip	59"	White	1-3/8"	1/2"	13/32"	3/4"	#102559	\$30.95 EA

## RECMAR CURTAIN TRACK & HARDWARE

RECMAR offers a variety of integrated curtain track hardware designed to work flawlessly with designated track designs. RECMAR's I-Beam Curtain Track System is very flexible, easy to bend, and works well with curves and corners. This sliding curtain system allows for smoother transitions and movement along the track.

### RECMAR BENDABLE I-BEAM CURTAIN TRACK

Silver anodized aluminum I-Beam ceiling or wall mount track with satin finish. Bends easily by hand up to a minimum 2" radius. Rust-proof, chip-proof clear finish. Splice end to end with a ceiling or wall splicer. Use a valance box to hide track and carriers from view. Dimensions: .25"W x .65"H.

48" Length #103060 \$10.95 EA

72" Length #103502 \$15.95 EA

### RECMAR I-BEAM CEILING BRACKET

Mount RECMAR I-Beam Curtain Track to ceiling. Install in the center of each track section and at the extreme ends of the total length of track. Use RECMAR Ceiling Splicers (#103065) to join lengths of track together. Mounts to horizontal or ceiling surfaces. Aluminum bracket. Hole size: 5/32". Screws not included.

#103064 \$1.95 PK2

### RECMAR I-BEAM TRACK CEILING SPLICER

Join sections of RECMAR I-Beam Curtain Track together. Set screws lock track in place at the joint. Also mounts to the ceiling as a ceiling bracket. Use with RECMAR Ceiling Brackets (#103064). Aluminum. Hole size: 5/32". Mounting screws not included.

#103065 \$2.95 EA

### RECMAR I-BEAM TRACK WALL SPLICER

Connect RECMAR I-Beam Curtain Track together when mounted to a wall or vertical surface with wall brackets. Set screws lock track into place at the joint for a smooth transition. Use with RECMAR Wall Brackets (#103067). Hole size: 5/32". Mounting screws not included.

#103068 \$7.95 EA

### RECMAR I-BEAM TRACK WALL BRACKET

Mount RECMAR I-Beam Curtain Track to the wall or a vertical surface. Provides 1-1/4" clearance. Install an aluminum wall bracket about every 2 feet of track. Use RECMAR Wall Splicer (#103068) to join track together. Hole size: 5/32". Screws not included.

#103067 \$8.95 PK2

### RECMAR DELUXE SHOWER CURTAIN KIT

Bendable 72" ceiling mount anodized aluminum track with satin finish. Shackles on nylon wheel carriers secure with set screws and clamp through holes in shower curtain. Includes a 72" long track, 5 ceiling brackets with screws, 2 end stops, and 12 wheel carriers with shackle and set screws.

#103061 \$29.95 KIT

RECMAR STAINLESS STEEL J HOOK Easily attach any carrier with a ring to curtains with holes or grommets. Will not rust or corrode. 1.5"L.

#103070 \$6.95 PK14

### RECMAR WRINKLE BAND TAPE (SHIRRING TAPE)

White 1" cotton tape with hooks and threaded loops for attaching curtains or drapes to track. Sew along the top edge of curtains and attach using Wrinkle Band Curtain Hooks (#103087). Loops spaced about 1-1/2" apart.

#103086

1-299 \$0.70/FT 300+ \$0.63/FT

### RECMAR WRINKLE BAND HOOKS

Use with Wrinkle Band Tape (#103086) and Nylon Block Carriers (#103062) to attach curtains to curtains carriers. Space hooks about 4" apart. Bend open with needle nose pliers for installation. Stainless steel. 1-1/4" L.

#103087 \$1.95 PK14

### RECMAR CURTAIN TRACK END STOP

Plated steel end stop with easy to adjust set screw. Use with RECMAR I-Beam Curtain Track.

#103069 \$0.95 PK2

### RECMAR SNAP-IN RETAINER CATCH

Snap RECMAR I-Beam Curtain Track into place. Mount a plastic clip about every 2 feet of track. Use RECMAR Ceiling Splicer (#103065) to join track together. Hole size: 5/32". Mounting screws not included.

#103066 \$6.95 PK10

### RECMAR NYLON WHEEL CARRIER WITH BRASS RING

Provide easy transport over RECMAR I-Beam Curtain Track. Zinc plated brass arc and ring ride on nylon wheels for use in wet conditions. Use for light duty curtains only. Space about 4" apart.

#103063 \$4.95 PK14

### CURTAIN BALL CARRIER FOR FLEX-A-RAIL TRACK

Perfect for use indoors and out! Slides smoothly in track. Sandwich fabric in the carrier's jaws and tighten screws.

White #105186 \$14.95 PK10

Black #120173 \$14.95 PK10

### RECMAR NYLON WHEEL CARRIER WITH SHACKLE

Slide smoothly over the RECMAR I-Beam Curtain Track. Features two nylon wheels with a nylon shackle. Shackles secure with set screws that clamp through the curtains. Space about 4" apart.

#103967 \$8.95 PK10

### RECMAR NYLON BLOCK CARRIER

Slide smoothly over RECMAR I-Beam Curtain track. Attach to curtain using a J Hook (#103070) and 5/8" grommet (installed along the top edge of the curtain) or with Wrinkle Band Tape & Curtain Hooks (#103086 & #103087). More durable than Nylon Wheel Carriers (#103063). Space about 4" apart.

#103062 \$10.95 PK14



# CURTAIN TRACK & HARDWARE

Our standard low profile horizontal, vertical, or surface mount track is available in aluminum (etched, anodized, siliconized, rust-proof, chip-proof, clear satin finished) or B.F. Goodrich® vinyl (flexible, noncorrosive, friction free). Both are light, attractive, and able to withstand high impact. Screw in place, or for an alternate installation method, we recommend using a hot glue gun (#103684 p.192) with Acrylic Glue Sticks (#102210, p.192).

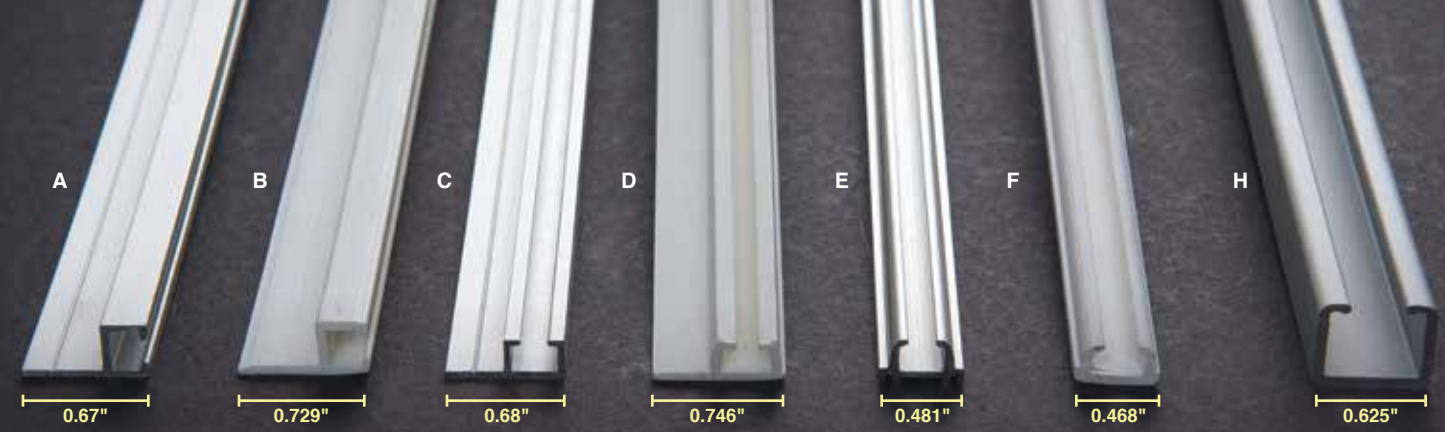

For complete dimensions visit [Sailrite.com](http://Sailrite.com)

## VERTICAL MOUNT CURTAIN TRACK

Affix directly to the wall with screws (#125811, one per foot). Screws not included.

- A 48" Aluminum #100877 \$12.40 / 4 FT
- B 48" Vinyl #100913 \$3.85 / 4 FT
- 4 x 1/2" Self-tapping Screw #125811 \$1.25 PK10

## HORIZONTAL MOUNT CURTAIN TRACK

Install directly to ceiling with screws (#125811). Pre-drill holes in outer flange and screw in place (one per foot). Screws not included.

- C 48" Aluminum #52105 \$9.20 / 4 FT
- D 48" Vinyl #100758 \$11.55 / 4 FT
- 4 x 1/2" Self-tapping Screw #125811 \$1.25 PK10

## SURFACE MOUNT CURTAIN TRACK

Affix directly to ceiling or side surfaces with Mounting Clips and screws.

- E 48" Aluminum #100880 \$10.20 / 4 FT
- F 48" Vinyl #100910 \$9.60 / 4 FT
- G Mounting Clip #102573 \$1.95 PK5
- 6 x 3/4" Flat-head Screw #526100 \$0.95 PK10

## CEILING MOUNT CURTAIN TRACK

Install directly to ceiling with screws (#100276). Pre-drill holes in the center of the track every 4-6". Screws not included. Requires Ceiling Mount Curtain Track hardware.

- H 55" Aluminum #104918 \$17.50 / 55 IN
- Screw #6 x 3/4" Pan Head Stainless #100276 \$2.30 PK10



### PIN-ON DRAPERY HOOKS

Ideal for hanging draperies, curtains, and valances. Use with shirring tapes, pinch pleats, or flat panels.

#102994 \$1.95 PK14

### EYELET CARRIERS

Attach drapery fabric to track. Compatible with all mount profiles. Whip eyelet end to fabric with thread. White nylon.

7/16" L x 3/16" W (1/8" inside) x 9/16" H.  
#318400  
1-9 \$1.95 PK10 10+ \$1.76 PK10

### SEW-ON TAB TAPE

White nylon tape with clear nylon tabs pre-sewn to the tape every 4" on center. Simply sew the tape to the fabric for easy curtain installation. Tab dimensions: 3/16" Dia., 1-3/16" L.

#100878  
1-299 \$0.80/FT 300+ \$0.72/FT

### SEW-ON TABS

Sew directly onto the fabric to accommodate either a flush overhead or side mounted installation.

#310021  
1-9 \$1.95 PK10 10+ \$1.76 PK10

### DRAPERY WEIGHTS

Plastic covered metal drapery weight that can endure wet conditions. Sew in place in the bottom hem of curtains.

1" x 1" square.  
#100186 \$3.95 PK10

### I END STOP WITH LOOP

Slide onto end of curtain track and lock in place. Whip fabric to loop. White nylon.

#310081 \$1.95 PK5

### J SNAP-ON TAPE

Sew directly to the fabric. Use with the Snap-On Carrier (#102211). Snaps positioned 4-1/4" on center.

#100911  
1-299 \$0.90/FT 300+ \$0.81/FT

### K SNAP-ON CARRIER

Use with the Snap-on Tape (#100911). Designed for use with the Horizontal Mount Track but can be used with the other two tracks as long as the slot is on the side. Outer diameter: 0.485" Inner diameter: 0.275".

#102211  
1-9 \$1.95 PK10 10+ \$1.76 PK10

### SCREW STOP

Square metal curtain stop. Slide into track and tighten.

#100879 \$3.95 PK5

## CEILING MOUNT CURTAIN TRACK HARDWARE

Only for use with the Ceiling Mount Curtain Track #104918 (p.187)

### BUTTON CARRIER FOR CEILING MOUNT CURTAIN TRACK

Use to hang draperies with the Ceiling Mount Curtain Track. Accepts drapery hooks or can be sewn directly to fabric. Nylon.

#104922  
1-9 \$2.95 PK10 10+ \$2.66 PK10

### BUTTON CARRIER WITH STAINLESS STEEL HOOK

Use to hang even heavy curtains on the Ceiling Mount Curtain track. Can be used with an installed grommet or Wrinkle Band Tape (p.185). Hook can be pinched closed with pliers.

#104921  
1-9 \$3.95 PK10 10+ \$3.56 PK10

### END STOP FOR CEILING MOUNT CURTAIN TRACK

Stainless steel curtain stop. Slide into the Ceiling Mount Curtain Track and tighten.

#104920 \$6.95 PK4

### SINGLE SNAP CARRIER FOR CEILING MOUNT CURTAIN TRACK

Use with the Snap On Tape (#100911) for Curtains and the Ceiling Mount Curtain Track. Strong enough to hold even heavy applications indoors and out.

#104919  
1-9 \$1.95 PK10 10+ \$1.76 PK10

BUY MORE, SAVE MORE! Quantity pricing available at [Sailrite.com](http://Sailrite.com)

# FRAME HARDWARE

Create a strong foundation for your bimini, dodger, enclosure, or awning with our heavy-duty stainless steel and nylon frame fittings. Mix and match with our aluminum or stainless steel tubing (p.190) to create a customized design and fit for any framing application.



## TUBING CONNECTORS

Attach tubing sections for railings, bimini and dodger frames, stanchions, solar panels, and other framing. Type 316 stainless steel for maximum corrosion resistance and durability.

- UNIVERSAL TEE**  
 60° - 7/8" tubing #103612 \$10.95 EA  
**A** 60° - 1" tubing #103613 \$11.95 EA  
 90° - 7/8" tubing #103614 \$10.95 EA  
**B** 90° - 1" tubing #103615 \$11.95 EA

- 3-WAY RAIL CORNER**  
 90° - 7/8" tubing #103616 \$15.95 EA  
**C** 90° - 1" tubing #103617 \$15.95 EA

- ELBOWS**  
 90° with Anchor Eye - 7/8" tubing #103621 \$14.95 EA  
**D** 90° with Anchor Eye - 1" tubing #103622 \$14.95 EA  
 90° - 7/8" tubing #103623 \$9.95 EA  
**E** 90° - 1" tubing #103624 \$10.95 EA

- RECTANGLE BASE**  
 Easy 1/4" screw installation (screws not included).  
 30° - 7/8" tubing (3" x 1-3/4") #103619 \$11.95 EA  
**F** 30° - 1" tubing (3-1/2" x 1-3/4") #103620 \$13.95 EA  
**G** 45° - 7/8" tubing (3" x 1-3/4") #103606 \$10.95 EA  
**G** 45° - 1" tubing (3-1/4" x 1-3/4") #103607 \$12.95 EA  
 60° - 7/8" tubing (3" x 1-3/4") #103608 \$11.95 EA  
**H** 60° - 1" tubing (3" x 1-3/4") #103609 \$13.95 EA  
 90° - 7/8" tubing (2-7/8" x 1-3/4") #103610 \$11.95 EA  
**I** 90° - 1" tubing (3" x 1-3/4") #103611 \$12.95 EA

## QUICK RELEASE PIN FRAME FITTINGS

Quick frame assembly and disassembly! Type 316 stainless steel fittings. Secures with stainless steel quick release clevis pin with spring and key ring (sold separately).



- J JAW SLIDE**  
 Attach one tubing bow to another with an eye end. Use with appropriate 7/8" or 1" tubing.  
 7/8" Jaw Slide #103052 \$6.95 EA  
 1" Jaw Slide #103054 \$6.95 EA



- K FLAT MOUNT PLATE**  
 Attach a 7/8" aluminum or 1" stainless steel frame with eye end to a flat surface like a cockpit coaming strip. Base size: 3/4" x 2". Drilled for #10 screws.  
 Flat Mount Plate #103051 \$5.95 EA



- L QUICK RELEASE PIN**  
 Stainless steel pin. Spans up to 7/8" width. Pin diameter: 1/4".  
 Quick Release Pin #103053 \$1.95 EA

## JAW SLIDES

Use with eye end to attach one tubing bow to another on bimini or dodger frames. Hinged jaw slides open apart for easy installation on rail without disassembling the frame. Nylon or Type 316 stainless steel. Includes set screws.



- M STAINLESS STEEL**  
 7/8" tubing #33208 \$7.95 EA  
 1" tubing #42102 \$7.95 EA  
 Extra Set Screws #653100 \$3.95 PK10



- N HINGED STAINLESS STEEL**  
 7/8" tubing #110164 \$15.95 EA  
 1" tubing #110165 \$15.95 EA  
 1-1/4" tubing #103304 \$19.95 EA  
 Extra Set Screws #653100 \$3.95 PK10



- O BLACK NYLON**  
 3/4" tubing #100691 \$1.80 EA  
 7/8" tubing #100692 \$1.95 EA

## EYE ENDS

Secure at tubing ends and bolt to a deck mount, jaw slide, side mount, or universal deck hinge. Nylon eye ends fit inside tubing. Type 316 stainless steel or nylon. Includes set screw.



- P STAINLESS STEEL**  
 3/4" tubing #103625 \$6.95 EA  
 7/8" tubing #207 \$5.95 EA  
 1" tubing #42101 \$7.95 EA  
 Extra Set Screws #653100 \$3.95 PK10
- Q BLACK NYLON**  
 3/4" tubing (5/8" ID) #100673 \$0.65 EA  
 7/8" tubing (3/4" ID) #100681 \$0.65 EA

## SIDE MOUNTS

Provide 1" stand-off space for grab rails or hold a tensioning bar where a stand-off structure bypasses intermediate frames. Compatible with standard marine end fittings. Sliding mounts may require frame disassembly, split mounts hinge open around tubing without frame disassembly. Includes tubing attachment hardware. Heavy duty, polished Type 316 stainless steel with bright marine finish.



- R Sliding Side Mount**  
 7/8" tubing #100697 \$15.95 EA  
 1" tubing #100698 \$16.95 EA



- S Split Side Mount**  
 7/8" tubing #102346 \$24.95 EA  
 1" tubing #102347 \$25.95 EA

## DECK MOUNT PLATES

Flat Mount Plates attach to flat surfaces like the cockpit coaming. Concave mounting plates attach to rails and pulpits. Use Side Mount Plates for vertical surfaces. Angled plates eliminate the need for a wedge in most applications. Stainless steel or nylon.

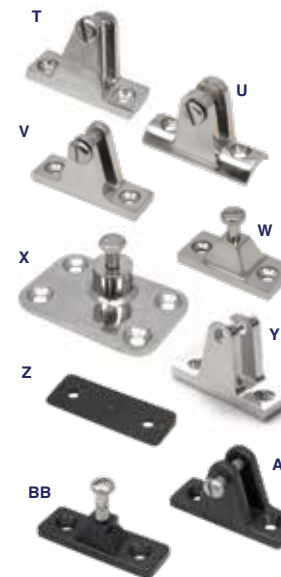

- STAINLESS STEEL**  
**T** Angled Mount Plate (80°) with Bolt #52103 \$5.95 EA  
**U** Concave Mount Plate #52104 \$5.95 EA  
**V** Flat Mount Plate #42103 \$6.95 EA  
**W** 2 Hole Side Mount (fits 7/8" eye ends) #28205 \$5.95 EA  
**X** 4 Hole Side Mount (fits 1" eye ends) #42104 \$13.95 EA  
**Y** Angled Mount Plate (80°) #120033 \$6.95 EA  
 Use with quick release Pin (L) #103053
- BLACK NYLON**  
**Z** Deck Hinge Wedge (10°) #100694 \$1.30 PK2  
**AA** Deck Hinge #100690 \$1.15 EA  
**BB** 2 Hole Side Mount (fits 7/8" eye ends) #100693 \$1.10 EA

## STANCHION HARDWARE

Designed for use with stanchions and lifelines. Polished type 316 stainless steel for maximum corrosion resistance and durability. Fits 1" tubing.



- CC STANCHION EYE**  
 Use on top of 1" x .065 wall stanchion poles (p.190). Weld or drill, tap, and screw in place. #883321 \$9.95 EA
- DD STANCHION SLEEVE WITH EYE**  
 Add lower lifelines without drilling additional holes. Fits 1" tubing. Hole size: 5/16". Set screw included. #883341 \$10.95 EA
- EE LIFELINE BASE**  
 Secure lifeline or other rigging to deck. Hole size: 3/8". Base: 2-3/8"L x 1-1/2"W x 1-1/8"H. Four 1/4" screw installation (screws not included). #882831 \$9.95 EA
- FF STANCHION BASE**  
 Heavy duty. Fits 1" tubing. Base: 3" x 3-3/4". Four 1/4" screw installation (screws not included). #103618 \$35.95 EA



## ADJUSTABLE EYE END

Create rigid struts to push away or pull together adjacent framing sections. Turn the tubing between the ends to change the length of the strut. Use to tighten canvas on bimini tops. Secure at tubing ends and bolt to a deck mount, side mount, jaw slide, or universal deck hinge. Type 316 stainless steel. Adjusts up to 2" in length. Use with 1" tubing. Includes one right and one left hand thread and set screws. #102550 \$48.95 PAIR



## QUICK RELEASE DECK HINGE

Quickly install or remove dodger or bimini frames with the press of a button! Low profile, quick release hinge snaps into base. When released, hinge stays attached to frame eye end. No cut-outs required. Flat surface mount. Type 316 polished stainless steel. Installs with 2 - #10 screws (sold separately, #103222).

- GG Hinge #103305 \$26.95 EA**  
**HH Replacement post #106740 \$11.95 EA**



## UNIVERSAL DECK HINGE

Mount your boat top frame to any surface. Pivoting hinge allows for the many different angles of decks and coamings, even vertical surfaces. Use with any eye end. Die cast Type 316 polished stainless steel. Includes eye end attachment screw. Installs with 2 - #10 x 1" screws (sold separately, #103222). #103120 \$17.95 EA

# TUBING

Shop tubing for dodger and bimini construction. Choose from Brite anodized 6063 T832 drawn aluminum or 304 stainless steel tubing with a super buff finish. Stainless steel tubing is all made in the USA. Stainless steel tubing in a 16 gauge is also great for stanchion poles.

We recommend cutting stainless steel tubing with a hacksaw or horizontal band saw and a blade with 24 teeth/inch.



	MATERIAL	LENGTH	OUTER DIAMETER	INNER DIAMETER	WALL THICKNESS	PART #	PRICE
A	Stainless Steel (Thick Wall)	1'	1"	0.86"	0.065" (16 Gauge)	#121042	\$7.95 EA
	Stainless Steel (Thick Wall)	2'	1"	0.86"	0.065" (16 Gauge)	#121043	\$14.95 EA
	Stainless Steel (Thick Wall)	3'	1"	0.86"	0.065" (16 Gauge)	#121044	\$21.95 EA
	Stainless Steel (Thick Wall)	4'	1"	0.86"	0.065" (16 Gauge)	#121045	\$28.95 EA
	Stainless Steel (Thick Wall)	5'	1"	0.86"	0.065" (16 Gauge)	#121046	\$36.95 EA
	Stainless Steel (Thick Wall)	6'	1"	0.86"	0.065" (16 Gauge)	#121047	\$43.95 EA
	Stainless Steel (Thick Wall)	7'	1"	0.86"	0.065" (16 Gauge)	#121048	\$50.95 EA
	Stainless Steel (Thick Wall)	8'	1"	0.86"	0.065" (16 Gauge)	#121049	\$57.95 EA
B	Stainless Steel	1'	1"	0.88"	0.049" (18 Gauge)	#121111	\$6.95 EA
	Stainless Steel	2'	1"	0.88"	0.049" (18 Gauge)	#121112	\$12.95 EA
	Stainless Steel	3'	1"	0.88"	0.049" (18 Gauge)	#121113	\$18.95 EA
	Stainless Steel	4'	1"	0.88"	0.049" (18 Gauge)	#121114	\$25.95 EA
	Stainless Steel	5'	1"	0.88"	0.049" (18 Gauge)	#121119	\$31.95 EA
	Stainless Steel	6'	1"	0.88"	0.049" (18 Gauge)	#121120	\$37.95 EA
	Stainless Steel	7'	1"	0.88"	0.049" (18 Gauge)	#121121	\$44.95 EA
	Stainless Steel	8'	1"	0.88"	0.049" (18 Gauge)	#121122	\$50.95 EA
C	Stainless Steel	1'	0.875" (7/8")	0.777"	0.049" (18 Gauge)	#121097	\$5.95 EA
	Stainless Steel	2'	0.875" (7/8")	0.777"	0.049" (18 Gauge)	#121098	\$10.95 EA
	Stainless Steel	3'	0.875" (7/8")	0.777"	0.049" (18 Gauge)	#121099	\$16.95 EA
	Stainless Steel	4'	0.875" (7/8")	0.777"	0.049" (18 Gauge)	#121100	\$21.95 EA
	Stainless Steel	5'	0.875" (7/8")	0.777"	0.049" (18 Gauge)	#121105	\$26.95 EA
	Stainless Steel	6'	0.875" (7/8")	0.777"	0.049" (18 Gauge)	#121102	\$32.95 EA
	Stainless Steel	7'	0.875" (7/8")	0.777"	0.049" (18 Gauge)	#121103	\$37.95 EA
	Stainless Steel	8'	0.875" (7/8")	0.777"	0.049" (18 Gauge)	#121104	\$43.95 EA
D	Aluminum	1'	0.875" (7/8")	0.759"	0.058"	#121081	\$3.95 EA
	Aluminum	2'	0.875" (7/8")	0.759"	0.058"	#121082	\$6.95 EA
	Aluminum	3'	0.875" (7/8")	0.759"	0.058"	#121083	\$9.95 EA
	Aluminum	4'	0.875" (7/8")	0.759"	0.058"	#121084	\$12.95 EA
	Aluminum	5'	0.875" (7/8")	0.759"	0.058"	#121085	\$16.95 EA
	Aluminum	6'	0.875" (7/8")	0.759"	0.058"	#121086	\$19.95 EA
	Aluminum	7'	0.875" (7/8")	0.759"	0.058"	#121087	\$22.95 EA
	Aluminum	8'	0.875" (7/8")	0.759"	0.058"	#121088	\$25.95 EA
E	Aluminum	1'	0.75" (3/4")	0.62"	0.058"	#121123	\$2.95 EA
	Aluminum	2'	0.75" (3/4")	0.62"	0.058"	#121124	\$5.95 EA
	Aluminum	3'	0.75" (3/4")	0.62"	0.058"	#121125	\$8.95 EA
	Aluminum	4'	0.75" (3/4")	0.62"	0.058"	#121127	\$11.95 EA
	Aluminum	5'	0.75" (3/4")	0.62"	0.058"	#121128	\$14.95 EA
	Aluminum	6'	0.75" (3/4")	0.62"	0.058"	#121129	\$16.95 EA
	Aluminum	7'	0.75" (3/4")	0.62"	0.058"	#121130	\$19.95 EA
	Aluminum	8'	0.75" (3/4")	0.62"	0.058"	#121131	\$22.95 EA



**SPRING BALL**  
Create a collapsible pole or frame with two sections of tubing that fit inside one another. Insert spring ball inside smaller tube and drill hole so the ball protrudes. Drill holes in the larger tube so it can slide over the depressed ball and lock in place when the ball springs up. Use with 7/8" and 1" tubing. Stainless steel.  
#208340 \$0.95 EA



**DRILL STEADY TUBING TOOL**  
Steady, no-slip, one-handed tube drilling tool designed for rocking boats and tough stainless steel. No frame disassembly required and simple to use. Swing onto tubing, clamp knobs down tightly, and drill. Use with 1/8" drill bit. Lifetime guarantee.  
#100967 \$51.95 EA



**TUBE CUTTING TOOL**  
Cut tubing with perfect alignment and precision. Strong, lightweight aluminum-alloy construction with grooved dual rollers. Enclosed wheel-feed screw helps eliminate clogging and jamming. Cuts up to 1-1/8" aluminum tubing. Includes a fold-away deburring reamer and 2 cutting wheels.  
Tube Cutter #1358 \$54.95 EA  
Replacement Cutting Wheel #1360 \$10.95 EA



**PROFESSIONAL RIVET TOOL**  
A professional rivet tool with a heavy duty steel construction. Comfortable vinyl grip with Hi-Viz non-slip finish. Spring-loaded handles for easy loading. Includes 3/32", 1/8", 5/32", and 3/16" nosepieces.  
#103520 \$23.95 EA

**BLIND STAINLESS STEEL RIVET FOR BIMINI & DODGER FRAMES**  
18-8 Stainless steel rivets used in Sailrite bimini and dodger frames to connect splines. Use #11 Drill bit to create 0.191"-0.201" hole. Diameter: 3/16". Length: 0.415". Shear strength: 1,400 lb.  
#103118 \$2.20 PK2

# BOAT HARDWARE



**CAM-LOCK SUPPORT POLES SNAP & SWEDGE TIP**  
Telescoping support poles to add center support to boat covers. Die cast collars and stainless steel components hold twice the weight of standard mooring poles. Body made from lightweight anodized aluminum. Use with a grommet, snap socket or Boat Vent II.  
#105131  
34" to 59" Adjustable \$13.95 EA  
39" to 70" Adjustable \$15.95 EA

**ADJUSTABLE SUPPORT POLES**  
Add adjustable center support for boat covers. Bright anodized aluminum tubing with a rubber cap end, nylon pole end (fits #2 spur grommet), and pole end with 3/4" stainless steel snap. (Each support pole comes with all 3 ends) Use with DOT® Durable Snap socket (#333050) and mating buttons.  
40" to 70" Adjustable #103041 \$13.95 EA  
48" to 96" Adjustable #103045 \$20.95 EA



**BOAT VENT II**  
Bring air circulation to your enclosed boat! Use in conjunction with the Cam-Lock Support Poles to create proper tenting of your boat cover and to increase airflow. Easy to install. Cut a small hole in the boat cover, separate the Boat Vent and sandwich fabric in between.  
#105135 \$9.95 EA



**SEWABLE BOAT VENT POLE CAP**  
Add air circulation under your boat cover with this easy to install, sewable boat vent. Large sewing flange makes installation easy and eliminates need for fabric reinforcement. Flexible cap is made from UV stabilized polyurethane. Use in conjunction with adjustable support poles.  
#120619 \$10.50 EA



**RUBBER SWIVEL PAD POLE BASE FOR CAM-LOCK SUPPORT POLES**  
Made exclusively for the 7/8" Cam-Lock Support Poles. Base swivels in any direction and has firm grip. Wide bottom disperses weight and protects the boat floor from damage.  
#105133 \$9.95 EA

## EZE TC-08 SHORT NOSE STAPLE GUN 80 SERIES 1/2" CROWN



Professional pneumatic staple gun that is lightweight and easy to use. Shoots 1/2" Crown Staples which are ideal for vinyl upholstery. Holds 100 staples. Requires 21 Gauge, 1/2" Crown Staples (sold separately).  
#104983 \$54.95 EA

## EZE TC-08 LONG NOSE STAPLE GUN 80 SERIES 1/2" CROWN

Professional quality pneumatic stapler with an extended nose to reach into tight spaces. Won't scar or scratch wood. Shoots 1/2" crown staples which are ideal for vinyl upholstery. Nose Length: 1-7/8" Holds 100 staples. Requires 21 Gauge, 1/2" Crown Staples (sold separately).  
#105509 \$79.95 EA



## STAPLES FOR EZE TC-08 STAPLE GUN 1/2" CROWN STAINLESS STEEL

1/4" #104981-14 \$26.95 PK10,000  
3/8" #104981-38 \$30.95 PK10,000  
1/2" #104981-12 \$34.95 PK10,000

## GALVANIZED

1/4" #104982-14 \$10.95 PK10,000  
3/8" #104982-38 \$11.95 PK10,000  
1/2" #104982-12 \$12.95 PK10,000  
9/16" #104982-916 \$12.95 PK10,000



## INDUSTRIAL STAPLER by Markwell

Heavy gauge, hardened steel industrial quality manual stapler with epoxy coating. Extremely lightweight — less than one pound! Designed for continuous heavy duty operation. Opens for tacking uses and easy top staple loading. Available with high rise clincher for stapling over boltropes, rolled material and ridges. Accepts Markwell P4 series staples and fine wire staples up to 1/2". Staples are galvanized steel.

**A** MPL4 Industrial Stapler #103285 \$67.95 EA  
**B** MPL4M High Rise Clincher #758100 \$99.00 EA  
1/4" P4A Staples (5,000) #724100 \$15.95 EA  
3/8" P4A Staples (5,000) #103293 \$13.95 EA



## PROFESSIONAL GRADE GLUE GUN by Surebonder

Professional high temperature glue gun with wire stand. Ergonomic long trigger requires less effort. Ideal for light duty industrial and packaging applications. Removable tip (male threads). Power: 80 watt, 120 volt. Fits 7/16" glue sticks.

Use the Long Nozzle Tip (with Nozzle Adaptor to fit HE-750 Glue Gun) for detail work and reaching into tight spots. Fits most standard 1/2" glue guns.

**C** HE-750 Glue Gun #103684 \$27.95 EA  
Acrylic Glue Stick (7.5") #102210 \$1.95 EA  
**D** Long Nozzle Tip #102667 \$7.95 EA  
**E** Nozzle Adaptor #103685 \$6.95 EA

## STAPLE REMOVER #120834 \$7.95 EA



## SCRATCH AWL

High-quality awl for use on expendable surfaces.  
#2354 \$3.95 EA



## SUNCOR LIFELINE KITS

Easy do-it-yourself lifeline kit featuring Quick Attach™ compression fittings so you can rig a lifeline and gate in minutes. Quick Attach turnbuckles with toggles allow for easy tensioning and provide a safe and secure alternative to open body fittings. Each kit contains hardware for one line on one side of a boat. Type 316 stainless steel fittings. WL: 620 lb. Use with 3/16" wire rope (not included in kits).

## QUICK ATTACH™ WITH CLOSED GATE

Includes: Gate Eye, Joined Gate Eye, Closed Body 3-3/4" Turnbuckle with Toggle (2), and Pelican Hook.  
#104848 \$184.95 EA



## QUICK ATTACH™ WITHOUT GATE

Includes: Toggle and Closed Body 3-3/4" Turnbuckle with Toggle.  
#104850 \$80.95 EA

## SUNCOR QUICK ATTACH™ HARDWARE

Quickly install lifelines with these easy to install parts. Made from marine grade Type 316 stainless steel. Fast attachment to any type of cable. Use with 3/16" wire.

**A** Joined Gate Eye #104315 \$68.95 EA  
**B** Gate Eye #104316 \$36.95 EA  
**C** Pelican Hook #104317 \$37.95 EA  
**D** Closed Body 3-3/4" Turnbuckle with Toggle #104314 \$44.95 EA  
**E** Toggle #104318 \$37.95 EA



## DOWNHAUL HOOK

Type 316 stainless steel hook with closed perpendicular eye. Use in reefing applications (ex. cargo lashing hook). Eye diameter: 1/2".

SIZE	LENGTH	HOOK LENGTH	PART #	PRICE
5/16"	2-1/2"	1-7/16"	#103766	\$4.95 EA
3/8"	3-1/2"	2"	#103767	\$7.95 EA



## QUICK PINS

Great for quick assembly and disassembly. Type 316 stainless steel pin with unique positive-locking system to prevent accidental release. Diameter: 1/4". Length: 1-1/2". Working load (double shear): 4,600 lb.

**H** Lock pin (one-handed push button release) #103783 \$13.95 EA  
**I** Traditional pin (pull release) #103784 \$4.95 EA



## SUNCOR STAINLESS STEEL LIFELINE WIRE

Use with Quick Attach™ Lifeline Kits. Type 316 stainless steel.

## F WHITE PVC-COATED 7X7 WIRE

Wire diameter: 3/16". OD: 5/16". WL: 620 lb. BL: 3,100 lb. Left hand lay.

PART #	30 FT.	40 FT.	50 FT.
#104853	\$37.95 EA	\$50.95 EA	\$62.95 EA

## G UNCOATED 1X19 WIRE

Wire diameter: 3/16". WL: 840 lb. BL: 4,200 lb. Right hand lay.

PART #	30 FT.	40 FT.	50 FT.
#104852	\$37.95 EA	\$50.95 EA	\$62.95 EA

## SUNCOR STAINLESS STEEL JAW & JAW WITH TURNBUCKLE

Open body turnbuckle made from grade 316 stainless steel. Ideal for lifelines and architectural cables.

THREAD DIA.	PART #	PRICE
1/2"	#105442	\$56.95 EA
3/8"	#105441	\$38.95 EA
5/16"	#105440	\$27.95 EA
1/4"	#105439	\$17.95 EA
3/16"	#105438	\$15.95 EA





Great for use on 15'-39' boats

## CDI FLEXIBLE FURLERS

Effective, inexpensive way to get more use and enjoyment from your boat while increasing safety. Furl or reef a jib, genoa, or staysail from the cockpit with ease!

PVC single groove luff extrusion is stiff in torsion for better reefing and furling yet flexible for easy handling when raising and lowering the mast. Great for trailerables and other boats where the mast is frequently raised and lowered. No joints to break or bend!

Smaller units have a one-piece UHMW polyethylene bearing (also available with ball bearings). Internal halyard eliminates halyard loads from bearings while raising and lowering sails to make reefing easier. Also eliminates halyard wraps and troublesome halyard swivels. Tack fitting is a simple lashing that won't fall overboard (unlike a pin or shackle). Durable one-piece urethane plastic furling drum with a stainless steel housing keeps furling line in place.

Although not designed to accommodate racing headsail changes, it is designed to meet the needs of the majority of boat owners. Plan 1 hour for installation, 15 minutes for removal, and 1 minute to uncover the turnbuckle for inspection or adjustment. Corresponding CDI Deck Hardware Kits also available.

TYPE	MAX. STUD SIZE	MAX. LENGTH HEADSTAY	PART #	MSRP	PRICE
FF1	1/4"	21'	#7000	\$510.00	\$434.95 EA
FF1*	1/4"	21'	#7000BB	\$615.00	\$479.95 EA
FF2	5/16"	29'	#7001	\$754.00	\$588.95 EA
FF2*	5/16"	29'	#7001BB	\$859.00	\$667.95 EA
FF4	3/8"	33'	#7003	\$937.00	\$731.95 EA
FF4*	3/8"	33'	#7003BB	\$1,132.00	\$882.95 EA
FF6	7/16"	39'	#7004	\$1,132.00	\$882.95 EA
FF6*	7/16"	39'	#7004BB	\$1,323.00	\$1,031.95 EA
FF7*	1/2"	47'	#7005	\$1,612.00	\$1,257.95 EA
FF9*	1/2"	53'	#7007	\$2,153.00	\$1,678.95 EA

\* Includes ball bearings.

### FEATURES:

- Easy reefing and furling
- Mounts on lower T-bolt of open body (Merriman type) turnbuckle
- UV stabilized PVC luff accepts #6 luff tape
- Zero maintenance!
- Spool drive type
- Rugged bearings
- 6 year manufacturer limited warranty
- Install over existing stay



### CDI DECK HARDWARE & FURLING LINE

Includes appropriate deck hardware and Sta-Set furling line for each size furler. Find a detailed parts listing for each kit at Sailrite.com.

FF6 Kit shown (#1365) ▶

USE WITH	LINE SIZE	LINE LENGTH	PART #	PRICE
FF1	5/32"	40'	#1393	\$61.30 KIT
FF2	3/16"	50'	#1362	\$94.30 KIT
FF4	1/4"	55'	#1364	\$107.30 KIT
FF6	1/4"	65'	#1365	\$151.25 KIT
FF7	1/4"	70'	#1366	\$164.15 KIT
FF9	1/4"	80'	#1367	\$170.15 KIT

\* Includes leech line instead of Sta-Set furling line.

## JIFFY REEFING KIT

(BOATS 22' AND UNDER)



Add a single row of reef points to the mainsail to increase sailing comfort and performance in a broader range of wind conditions. Sailrite's jiffy reef system focuses stress on the strongest parts of the sail — the leech and luff. Easily reef the sail for a smaller, flat sail within seconds. Installation: 2 hours.

#34301A \$67.45 KIT

Includes: 2 Jiffy grommets, 6 patches for reinforcement, 30' line, 1 bullet block, 2 strap eyes, 2 jam cleats, shock cord, 4 shock cord hooks, webbing reef points (2 each side), basting tape, thread, screws, and complete instructions.

Requires a zigzag sewing machine, hammer, screwdriver, and electric drill.

## HARKEN® LAZY JACK SYSTEMS

Contain and restrain the mainsail while reefing and furling. Quickly detach from the boom to permit the use of a sail cover without slots. Strong enough to be used as a topping lift for boats with extremely roached mainsails. Includes rope, fasteners, all hardware, and installation instructions.

BOAT LENGTH	BOOM LENGTH	MAIN LUFF LENGTH	PART #	MSRP	PRICE
21'-28'	7'-13'	21'-32'	#252100	\$312.05	\$274.99 KIT
27'-37'	10'6"-16'	32'-42'	#253100	\$439.50	\$386.99 KIT
35'-42'	12'-16'	35'7"-48'	#254100	\$675.70	\$594.99 KIT

\* Kits #252100 & 253100: 2 Container Legs. #254100: 3 Container Legs.



## COMMON SMALL BOAT FURLING LINE LEAD HARDWARE



### FAIRLEAD DEAD EYE BY RONSTAN

Nylon with stainless steel liner. Use as first throughway for furling line at boat's bow. Length: 1-1/2". Hole size: 9/16".

#1235 \$6.95 EA



### ROLLER FURLING BAIL

Accepts your favorite block, swivel or fixed eye. Use for final lead at cockpit and at bow if lead is severe. Easily mounts on 7/8" to 1" diameter stanchion or base.

#40505 \$22.95 EA



### ADD-A-CLEAT

Husky stainless steel bracket and clamp with 4-1/2" anodized aluminum cleat. Use to secure furling line. Mounts on 7/8" to 1" diameter stanchion or base.

#1237 \$25.95 EA



### ROLLER FURLING FAIRLEAD

Allows control line to be either inside or outside of stanchions. Mounts on 7/8" to 1" diameter stanchion or base. Easily installed, no drilling.

#1091 \$19.95 EA



### SADDLE BY RONSTAN

Mount blocks to deck. Fastening holes: 3/16" dia., 1- 1/4" centers. Fits 9/16" line. Screws not included. Stainless steel.

#13400 \$2.95 EA

Pan Head Screw (10 x 3/4")

#1785 \$0.20 EA



### HARKEN 166 BULLET BLOCK SINGLE WITH SWIVEL SHACKLE

Designed for all control applications where up to 5/16" line is used. Ideal for vangs, outhauls, cunninghams, spinnaker controls, traveler controls, barber haulers, and more. See p.206 for more information

#166100 \$29.40 EA \$25.99 EA

## WINCHRITE® ABT

BY SAILOLOGY

Lightweight, safe cordless electric winch handle designed specifically for use on sailboats. Now with an efficient 21.6v lithium ion battery and included holder for when not in use, this a perfect addition to your sailing gear!

The Advanced Brushless Technology (ABT) provides increased efficiency, greater torque and less internal heat. Unique drive prevents failure in both rotational directions and will not unthread or snap the retaining screw. Integrated rubber inlay for anti-skid prevention.

Use on all single and two speed winches where a standard eight point handle is utilized. Operate at lowest winch speed to ensure maximum pull and low battery consumption.

#105419 \$749.00 EA \$699.00 EA



### TECHNICAL SPECIFICATIONS:

- Torque: Achieves 130NM of torque to stall
- Rotation: 0-130 rpm via variable speed technology in both directions allowing for two speed winch rotations
- Drive: Integrated stainless steel standard winch cog
- Battery: Internal rechargeable 21.6V lithium ion
- Weight: 6.2 lb
- Warranty: 1-year limited

Includes: Multifomat 110/240v A/C charger, 12v D/C trickle charger, two drive cogs, travel/storage tote bag, mountable storage holder.

# GROMMETS

## PLAIN GROMMETS

Common brass grommets great for use in awnings, curtains, and flags. Requires plain grommet setting tools (p.197) for installation.



SIZE	PART#	1-11 PK	12+ PK
A #00 (3/16")	#103151	\$0.60 PK12	\$0.51 PK12
B <b>NEW</b> #0 (1/4")	#120807	\$1.05 PK12	\$0.95 PK12
C #1 (5/16")	#26304	\$1.05 PK12	\$0.89 PK12
#2 (3/8")	#26305	\$1.40 PK12	\$1.19 PK12
#3 (7/16")	#26306	\$2.30 PK12	\$1.95 PK12

## SPUR GROMMETS

Stronger than plain washer grommets and made from heavier metals. Use anywhere in place of sewn-in rings when the extra strength is not necessary. Spurs lock into place during installation and will not easily pull out of fabric. Install with spur grommet die sets and hole cutters only (p.197). Available in brass, nickel, or stainless steel.



SIZE	PART#	1-11 PK	12+ PK
<b>BRASS</b>			
#0 (1/4" I.D.)	#26307	\$2.95 PK12	\$2.66 PK12
#1 (5/16" I.D.)	#26308	\$2.95 PK12	\$2.66 PK12
#2 (3/8" I.D.)	#26309	\$3.95 PK12	\$3.56 PK12
#3 (7/16" I.D.)	#26310	\$3.95 PK12	\$3.56 PK12
#4 (1/2" I.D.)	#26311	\$5.95 PK12	\$5.36 PK12
G #5 (5/8" I.D.)	#26312	\$6.95 PK12	\$6.26 PK12

<b>NICKEL</b>			
#0 (1/4" I.D.)	#26314	\$2.95 PK12	\$2.66 PK12
#1 (5/16" I.D.)	#26315	\$2.95 PK12	\$2.66 PK12
#2 (3/8" I.D.)	#26316	\$3.95 PK12	\$3.56 PK12
E #3 (7/16" I.D.)	#26317	\$4.95 PK12	\$4.46 PK12
F #4 (1/2" I.D.)	#26318	\$5.95 PK12	\$5.36 PK12
#5 (5/8" I.D.)	#26319	\$7.95 PK12	\$7.16 PK12

<b>STAINLESS STEEL</b>			
D #2 (3/8" I.D.)	#354211	\$10.95 PK12	\$9.86 PK12

## NEW VENT GROMMETS

Low profile vent grommets, also known as ventilators or breathers, have small holes in the cap to allow ventilation. Often used on cushion backs to let air escape when the cushion is compressed. Made from 100% brass. Cut a 7/16" hole for a 3/4" vent grommet and a 5/8" hole for a 1" vent grommet. Vent grommet die sets (p.197) are required for installation.

1" #120748 \$3.95 PK12  
H 3/4" #120747 \$2.95 PK12



## SNAP TOGETHER GROMMETS

UV resistant, washable grommets that will not rust or corrode! Use for utility tasks like weather cloths, tarps, sun awnings, and shower curtains. Install in up to 4 layers of Sunbrella or 1/20" thick webbing. Install with a #5 hole cutter and hammer. Place wood on top of the grommet and tap to set through thicker fabrics. Polypropylene. I.D. 7/16". Breakout strength: 100 lb.



COLOR	PART #	1-19 PK	20+ PK
Black	#100200	\$2.95 PK5	\$2.66 PK5
I White	#100202	\$2.95 PK5	\$2.66 PK5
Beige	#100203	\$2.95 PK5	\$2.66 PK5

## EYELET GROMMETS & RINGS

High quality brass eyelet grommets and rings for use anywhere a purchase on fabric is required. Much stronger than plain or spur grommets. Sew rings to fabric with waxed twine and insert and flare the eyelet grommet inside the ring to protect twine from chafe. Requires a die set for eyelet installation (p.197).



SIZE	TYPE	PART #	PRICE
#3 (1/2" I.D.)	Ring	#26108	\$1.80 EA
J #6 (7/8" I.D.)	Ring	#26109	\$5.95 EA
K #6 (7/8" I.D.)	Eyelet	#26112	\$5.35 EA
#9 (1-1/4" I.D.)	Ring	#26110	\$7.60 EA
#9 (1-1/4" I.D.)	Eyelet	#26113	\$5.40 EA

## JIFFY GROMMETS

A Sailrite original! Recommended for use on spinnakers and working sails for boats under 22'. Anodized aluminum washers fit on each side of the fabric and set with soft aluminum rivets. Requires only a hammer for installation. As strong as a #6 ring and eyelet if reinforced with webbing on one side. I.D. 7/8". O.D. 1-1/2". Includes 2 washers and rivets.



L #26208A \$4.50 EA



# GROMMET SETTING TOOLS

## M HOLE CUTTERS

Cut holes for grommet and fastener installation. Stays sharp when used on proper cutting mat. Place mat on concrete surface and strike cutter with heavy mallet. Select a hole cutter size that corresponds with the grommet size (hole size will be slightly smaller than barrel of grommet).

1/8" - for Snap Fastener Installation #102235 \$22.95 EA

#0 (1/4") #18209 \$22.95 EA

#1 (5/16") #18210 \$22.95 EA

#2 (3/8") #18211 \$25.95 EA

#3 (7/16") #18212 \$25.95 EA

#4 (1/2") #18213 \$30.95 EA

#5 (5/8") #18216 \$37.95 EA

#6 (7/8") - for #6 eyelets #18214 \$37.95 EA

#8 (1") - for #9 eyelets #18215 \$44.95 EA

## N SELF-CENTERING PUNCH SET

Cleanly cuts holes in fabric, leather, rubber, paper, and plastic. Professional quality-tool with threaded handle, self-centering pointed plunger, and 9 interchangeable threaded cutting tubes with properly hardened edges.

Cuts hole sizes: 1/4", 5/16", 3/8", 7/16", 1/2", 5/8", 3/4", 7/8", and 1".

#100004 \$88.95 EA

## O PREMIUM CUTTING BLOCKS

Keep cutting tools sharp! Double-sided rigid plastic block. Safe on all boat and table finishes. Will last for many years. Hang tether. Made in USA.

5" x 5" #103651 \$6.95 EA

## P SPUR GROMMET DIE SETS

High quality die sets used to set spur grommets (not plain washer grommets). Great for awnings, sails, covers, and tarps! Lifetime use with proper care. Order the same size die set, hole cutter, and spur grommet.

#0 (1/4") #18201 \$32.95 EA

#1 (5/16") #18202 \$32.95 EA

#2 (3/8") #18203 \$33.95 EA

#3 (7/16") #18204 \$35.95 EA

#4 (1/2") #18205 \$35.95 EA

#5 (5/8") #85171 \$61.95 EA

## Q NEW VENT GROMMET DIE SETS

Die set specially designed to install vent grommets. This high quality tool will last a lifetime with proper care. Order the same size die set as vent grommet.

3/4" #120749 \$12.95 EA

1" #120750 \$12.95 EA

## REVOLVING PUNCH & REPLACEMENT TUBES

Great for making holes in leather or for holes for rivets in headboards or fasteners. Choose from the Basic Revolving Punch or the Professional Revolving Hole Punch. The basic model is a great starter tool, while the professional is great for long-term use. Both feature 6 cutting tubes. Distance from cutting tube to back of jaw is 1-1/2". Punch sizes: 3/32", 7/64", 1/8", 5/32", 11/64" and 3/16". Cutting tubes on the Professional Punch can be replaced.

Basic Revolving Hole Punch #120032 \$16.95 EA

R Professional Revolving Punch #100050 \$84.95 EA

Replacement Tubes (6 pc.) #102643 \$42.95 EA

## S HAMMER STYLE Mallet

Durable 3 lb. mallet makes grommet, fastener, and rivet installation a snap! Well made and heavy duty with leather handle, 3" nylon head, and brass fittings.

#68563 \$83.95 EA

## T EYELET DIE SETS

High quality die sets for installing brass rings and eyelets. Use to press eyelet grommets around sewn rings to protect lacing thread from chafe. Lifetime use with proper care.

Use a #6 hole cutter for #6 eyelet grommets and a #8 hole cutter for #9 eyelet grommets (hole cutters sold separately).

#6 (7/8") #18207 \$58.95 EA

#9 (1-1/4") #18208 \$59.95 EA

## U STAYPUT SPIN CUT TOOL

Attaches to your drill to "spin cut" a hole in fabric. Developed as a low impact hole cutting method that requires only a small cutting board. Mobile hole cutting wherever a hole is needed! The 5"x5" cutting block (#103651) is the perfect surface to drill against.

1/8" #104482 \$20.00 EA

1/4" #103437 \$22.00 EA

3/8" #103440 \$24.00 EA

7/16" #103548 \$32.00 EA



# GROMMET KITS



## COMPLETE #00 PLAIN GROMMET KIT

Very handy for installing #00 (3/16") grommets. Maximum material thickness: 1/16". Includes: Grommet setting pliers, hole punch, and 144-#00 brass grommets.

#103150 \$34.95/KIT



## GROMMET KITS

Light-duty common (plain washer) brass grommets great for use in awnings, curtains, and flags. Includes: Common washer grommets (24 in #0, #1 & #2 Kits, 12 in #3 Kits), setting tool, hole cutting tool, and wood cutting block.

- #0 (1/4") Kit #26300 \$12.95 KIT
- #1 (5/16") Kit #26301 \$12.95 KIT
- #2 (3/8") Kit #26302 \$13.95 KIT
- #3 (7/16") Kit #26303 \$15.95 KIT

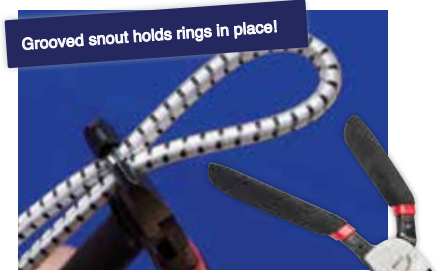

## HOG PLIERS & HOG RINGS

Quickly create a loop in the end of a length of shock cord. Squeeze together and tighten with hog pliers. Stainless steel rings.

- Hog Pliers #100950 \$18.95 EA
- 3/16" Rings #100951 \$1.20 PK10
- 1/4" Rings #100952 \$1.30 PK10
- 5/16" Rings #100956 \$1.60 PK10

# HEADBOARDS

## ANODIZED ALUMINUM HEADBOARDS

Very strong, lightweight headboards for boats over 20 feet. Use the 1/8" thick boards for boats over 30 feet. Includes 2 aluminum plates and rivets (set with hammer).



HEAD	LUFF	THICKNESS	PART #	PRICE
3-1/2"	4-7/8"	1/16"	#27305	\$17.30 EA
4"	5"	1/16"	#27306	\$16.00 EA
4-1/2"	5-3/4"	1/16"	#27307	\$17.70 EA
5-1/4"	6-1/2"	1/8"	#27308	\$28.65 EA
6"	6"	1/16"	#27309	\$28.60 EA

## TACK PLATES

Anodized aluminum plates with soft aluminum rivets. Specifically for use at sail corners. Recommended for boats up to 20 feet. Includes 2 aluminum plates and rivets.

#26210 \$10.80 EA



## CATAMARAN CLEW PLATE WITH RIVETS

For Hobie and Soling class jib clews. Includes 2 aluminum plates and rivets.

#233500 \$23.70 EA



## NYLON EXTERNAL HEADBOARDS

Light and inexpensive. For boats under 20 feet. Sew in place or secure with rivets. Includes 2 nylon plates and rivets.

- 3" x 4" #27311 \$5.50 EA
- 4" x 4.5" #27312 \$5.90 EA
- 4.5" x 5" #27313 \$7.55 EA



## HAMMER STYLE MALLET

Durable 3 lb. mallet makes grommet, fastener, and rivet installation a snap! Well made and heavy duty with leather handle, 3" nylon head, and brass fittings.

#68563 \$83.95 EA

## RIVETS

Use in headboards and leech line cleats. Set with center punch and hammer. Aluminum rivets (#333102) are also used with our jiffy grommets.



SEMI-TUBULAR ALUMINUM RIVETS (DIAMETER X LENGTH)			
1/8" X 3/8"	#333102	\$0.60	PK10
5/32" X 3/8"	#25002	\$1.50	PK10
3/16" X 3/8"	#98989	\$1.60	PK10
3/16" X 1/2"	#85257	\$1.40	PK10



TUBULAR BRASS RIVETS (DIAMETER X LENGTH)			
3/16" x 7/16"	#902100	\$2.80	PK10

# TOOL KITS

## CANVASWORKERS TOOL KIT

This kit contains all the essential tools you need to start making your own covers, awnings, tops and more! Hand-picked by our experts, this kit contains all the essential canvas working tools for beginners and experienced canvasworkers alike. All items in this kit are also sold separately.

#107120 \$857.85 KIT

You save \$45.11 when ordered as a kit

### CANVASWORKERS TOOL KIT INCLUDES:

- Sailrite Edge Hotknife (110V)
- F Blade
- Pres-N-Snap Installation Tool
- Pres-N-Snap Gypsy Stud Die
- Pres-N-Snap One Way Fastener Die
- DOT™ Snap Fastener Starter Kit (p.174)
- 10 Common Sense Fastener Eyelets
- 10 Common Sense Washers
- 10 Common Sense Fastener Clinch Plates
- 10 Common Sense 2 Prong Studs
- Canvas Patterning Ruler
- Speedy Stitcher Sewing Awl
- Gingher Scissors (Right Handed)
- Mallet Hammer
- Quick Fit Kit (p.174)
- #1 Spur Die Set
- #2 Spur Die Set
- Common Sense Eyelet Hole Cutter
- Self-Centering Hole Cutting Set
- Rubber Cutting Block
- 10 #1 Brass Spur Grommets
- 10 #1 Nickel Spur Grommets
- 10 #2 Brass Spur Grommets
- 10 #2 Nickel Spur Grommets
- White Soapstone Fabric Marking Pencil
- Black Grease Marking Pencil



## SAILMAKERS TOOL KIT

Hand-picked by our experts, this kit includes all the tools any beginner needs to get started making sails. It's also a great easy-to-order tool kit of all the essentials for the experienced sailmaker. All items in this kit are also sold separately.

#107121 \$554.00 KIT

You save \$29.15 when ordered as a kit

### SAILMAKERS TOOL KIT INCLUDES:

- Sailrite Edge Hotknife (110V)
- F Blade
- Adjustable Palm (Right Hand)
- Hand Sewing Needles (in a waterproof tube) PK10.
- 5-ply Waxed Flat Twine
- Swivel Bench Hook
- Scratch Awl
- Deluxe Seam Ripper
- Gingher Scissors (Right Handed)
- Mallet Hammer
- Premium Cutting Block
- #2 Spur Die Set
- #5 Spur Die Set
- Self-Centering Hole Cutting Set
- 10 #2 Brass Spur Grommets
- 10 #2 Nickel Spur Grommets
- 10 #5 Brass Spur Grommets
- 10 #5 Nickel Spur Grommets
- Seamstick 3/8" Basting Tape for Canvas
- Seamstick 1/4" Basting Tape
- The Sail Repair Manual





## ASSEMBLED COLLAPSIBLE STRUTS

Stronger and sturdier dodger or bimini frame supports yet still collapsible! Oversized sleeve slides over joint (hinge) and locks in place with two spring ball end-stops for a secure fully load bearing joint that cannot be accidentally dislodged. Prefabricated folding struts with stainless center hinges, tubing, and roll-pins. Two eye ends and appropriate mounts are recommended for installation (sold separately).

7/8" Tubing, 36" Extension Length **#102348 \$75.95 EA**

7/8" Tubing, 72" Extension Length **#103044 \$81.95 EA**

1" Tubing, 36" Extension Length **#102349 \$81.95 EA**

1" Tubing, 72" Extension Length **#103042 \$85.95 EA**



## RIGID SUPPORT STRUT KITS

Replace webbing straps on dodger and bimini frames for greater strength and longevity. Many cruisers find this trade-off well worth it! Kit assumes struts attach to the legs of the fore or aft frame bow and run to the deck or coaming of the boat.

Kits include: 3 ft. long tubing (2), stainless steel eye ends (4), stainless steel jaw slides (2), flat mount plates (2), and instructions.

7/8" Aluminum **#100267 \$73.50 KIT**

**NEW** 7/8" Stainless Steel **#121152 \$87.50 KIT**

1" Stainless Steel **#100268 \$99.50 KIT**

### PREMIUM RIGID SUPPORT STRUT KITS

Kits include: 3 ft. long tubing (2), stainless steel eye ends (4), stainless steel hinged jaw slides (2), Universal Deck Hinges (2), and instructions.

**NEW** 7/8" Stainless Steel **#121153 \$125.50 KIT**

**NEW** 1" Stainless Steel **#121154 \$137.50 KIT**



## GRAB RAIL KIT

Increase safety on your sailboat and add structural integrity to your dodger or bimini frame! Easy installation with no drilling, modifications, or difficult set-up of existing frame required. Use as grab rails or as tensioning bars to automatically bypass intermediate frames. Mounts allow for 1" clearance and maximum length is 36.5" from center line of framing.

Includes: Bright 304 polished .049" stainless steel tubing, cast 316 polished stainless steel eye ends and sliding or split side mounts, thread, leather, and instructions. (Kits with split side mounts do not require disassembly of the frame during installation.)

7/8" Tubing **#102424 \$70.20 KIT**

7/8" Tubing with Split Side Mounts **#102492 \$88.20 KIT**

1" Tubing **#102193 \$78.20 KIT**

1" Tubing with Split Side Mounts **#102493 \$96.20 KIT**



### GRAB RAILS

Attach to your boat, dodger, or bimini frame to provide a convenient hand hold. Durable 304 stainless steel. Round 7/8" diameter. Wall thickness: .049".

12" Length (Screws: 1/4" x 20 thread, 1" studs)

**#869100 \$18.95 EA**

19-3/4" Length (Screws: 5/16" x 18 thread, 2" studs)

**#873100 \$20.95 EA**



### NYLON KNOB WITH 6" SWIVEL CABLE

Use as replacement for the standard pivot bolt of die cast stainless steel boat top hardware. Nylon thumb knob with 7/8" stainless steel screw (1/4-20 thread). Available on 6" swivel cable.

Thumb Knob w/Cable **#100644 \$2.40 EA**

Thumb Knob **#100643 \$0.95 EA**



### SUN-BLOCKER CLIPS

Reduce scorching and heat cracking of plastic window material. Self-insulated protective clip keeps plastic windows from touching the metal tubing on dodgers. Includes cooling air vents and rounded corners that eliminate abrasion. Clip in place.

7/8" Tubing **#203311 \$3.95 PK5**

1" Tubing **#203411 \$4.95 PK5**



### SEWABLE D-RING

Eliminate the need for cutting and sewing an extra web attachment piece. Sew in place. Opening: 1"W x 5/8"H. Nylon. Black.

**#95507 \$2.00 PK10**



▲ D-Ring with Bar

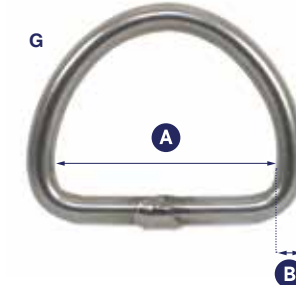
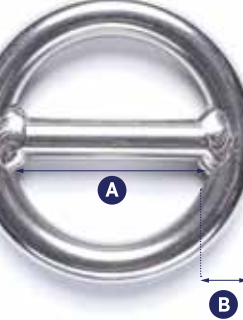
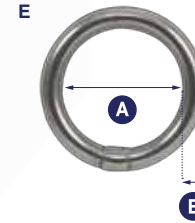

### E ROUND RING

Use smaller ring for head and tack corners of roller reefing headsails. Use larger ring at head and tack corners of larger roller reefing headsails, clews, and in safety harnesses. Also great for structural awnings. Attach with webbing strap. Stainless steel.

	A INNER DIA.	B WIRE DIA.	BAR	PART #	PRICE
E	1.211"	0.233"	No	#23232	\$2.95 EA
	1.969"	0.310"	No	#45697	\$4.95 EA

### F MAXI ROUND RING WITH BAR

This ring is generally used as the clew ring for boats over 40 feet in length. This is the appropriate ring for bigger sails on larger boat applications. Attach with webbing strap.

	A INNER DIA.	B WIRE DIA.	BAR	PART #	PRICE
F	3"	0.624"	Yes	#120217	\$31.95 EA

### G D-RINGS

Use anywhere a line must be secured to fabric like headsail clews and spinnaker corners. Secure in place with webbing strap. D-rings with bars do not twist. Stainless steel.

SIZE	A LENGTH	B WIRE DIA.	BAR	PART #	PRICE
#0	1"	0.1875"	No	#485	\$1.95 EA
#1	1.5"	0.1875"	No	#25304	\$2.95 EA
#2	2"	0.25"	No	#25305	\$3.95 EA
#3	2.375"	0.307"	No	#25306	\$4.95 EA
#3	2"	0.25"	Yes	#25308	\$7.95 EA
#4	2.375"	0.305"	Yes	#25309	\$9.95 EA



### AIR-FLOW TELS™

Show air flow across a sail to maximize performance when trimming sails. Lightweight, ripstop nylon TELS attach to sail with waterproof adhesive locator discs. No holes required. Includes 14 TELS and instructions on application and interpretation.

**#4353 \$7.95 EA**



### HARKEN HANDHOLD

Popular on boats like solings and scows to help hiking crews re-enter the boat or use as a handle for engine covers, etc. Includes drain holes.

**#106210 \$13.45 EA**



### EASYKLIP® MIDI

Strongest tarp clip on the market! Multi-functional grommet-free fastener designed to grip tarps, car covers, fabric canopies, and plastic banners. Grip increases as load increases. UV resistant. Reusable. Fabrics up to 6 mm. Load: up to 220 lb. Glass-reinforced nylon.

White **#103821 \$8.99 PK4**

Black **#103815 \$8.99 PK4**



### SPINNAKER HOOPS

Hold open the top of a spinnaker bag when taking down sails. 3/16" stainless steel wire.

12" Diameter **#51400 \$8.95 EA**

16" Diameter **#51500 \$10.95 EA**

20" Diameter **#51600 \$12.95 EA**

24" Diameter **#11730 \$15.95 EA**



# SLUGS, SLIDES & SHACKLES

Most mainsails are finished with a 5/16" boltrope slid into a slot along the aft edge of the spar. Sew a cloth sleeve around the roped edge of the sail or just the rope and then sandwich the sail to seal the leading edge to the spar for excellent aerodynamic performance.

The disadvantages to using just a boltrope sleeve are that the luff comes out of the track every time the sail is lowered possibly catching wind and becoming difficult to manage and the rope and/or sleeve will wear with use.

The main reason to use slugs and slides is to facilitate sail handling. With the use of a sail stop, slugs and slides allow for the sail to quickly and easily stack in the mast slot rather than coming out of the track.

Slugs and slides also reduce wear on the sail and slide easily up and down the mast, unlike boltroped sail edges.



## DEFINITIONS

- Slugs have a round barrel that feeds into the mast slot instead of the boltrope and a bail for attaching to the sail.
- Internal Slides have a flat end, similar to a T shape, that feeds into the mast slot instead of the boltrope and a bail for attaching to the sail.
- External Slides are used with external metal track, often found on traditional boats with wooden spars.
- Shackles secure around the bail of a slug or slide and attach to the sail, and most must be used with a grommet installed along the edge of the sail.

## DIMENSIONS

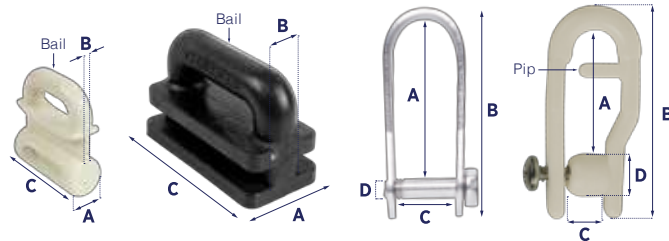

## ATTACHMENT METHODS

- The strongest and most common attachment is with a shackle and grommet. However, one shackle can be used without needing a grommet.
- Webbing is more labor intensive but allows for greater articulation of the slug position. Sew directly to the sail with a sewing machine or attach with waxed twine and hand needle through a grommet.

### SAIL HARDWARE COMPATIBILITY CHART p.251

Determine which slugs and slides are compatible with each shackle.

### STAINLESS BAIL SAIL SLUGS

Nylon barrel w/ rocker and stainless steel bail. Rocker prevents tilting in slot.

	A DIA.	B WAIST	C LENGTH	ROCKER	PART #	PRICE
	5/16"	3/32"	1-1/16"	Yes	#23312	\$1.45 EA
A	13/32"	1/8"	1-3/16"	Yes	#23313	\$1.65 EA
	7/16"	1/8"	1-3/16"	Yes	#23314	\$1.65 EA
	3/8"	1/8"	1-3/16"	No	#67311	\$1.10 EA
B	1/2"	1/8"	1-3/16"	No	#67511	\$1.10 EA

### STAINLESS STEEL WELDED SLUGS

Extremely strong stainless steel slugs.

	A DIA.	B WAIST	C LENGTH	PART #	PRICE
	5/16"	1/8"	1-3/8"	#1390	\$6.30 EA
C	7/16"	1/8"	1-3/8"	#1391	\$6.60 EA

### ALL NYLON ROUND SAIL SLUGS

Nylon barrel w/ rocker. Prevents tilting in slot.

	A DIA.	B WAIST	C LENGTH	PART #	PRICE
D	5/16"	1/8"	1-1/16"	#23307	\$0.50 EA
E	3/8"	1/8"	1-1/16"	#23319	\$0.60 EA
	1/2"	1/8"	1-1/16"	#23308	\$0.55 EA

### ALL NYLON FLAT SAIL SLIDES

Injection molded in nylon 66. For use in rectangular slots.

	A WIDTH	B WAIST	C LENGTH	PART #	PRICE
F	5/8"	1/4"	1-3/16"	#23309	\$0.50 EA
G	3/4"	3/8"	1-5/16"	#23310	\$0.65 EA
	7/8"	7/16"	1-3/8"	#23311	\$0.75 EA

### STAINLESS FLAT TRACK SLIDES

Use where maximum strength from an internal track slide is required like at the headboard, clew outhaul, or around luff reef rings.

	A WIDTH	B WAIST	C LENGTH	PART #	PRICE
	5/8"	1/4"	1-7/16"	#1379	\$11.40 EA
H	3/4"	1/4"	1-7/16"	#1900	\$10.70 EA
	7/8"	1/4"	1-7/16"	#1380	\$11.00 EA

### SELDEN MAST PLASTIC SLIDES

	A WIDTH	B WAIST	C LENGTH	PART #	PRICE
	7/16"	1/8"	7/8"	#103038	\$1.00 EA
I	9/16"	5/32"	1-3/16"	#103039	\$1.15 EA
J	5/8"	5/32"	1-5/8"	#103040*	\$2.10 EA

\*Designed for use on boats over 40 ft.

### STAINLESS SCREW SHACKLES

Stronger and more positive bolt closure than plastic shackles. Structurally reinforced to minimize deformation under extreme loads. Installation requires a grommet. Use with plastic insert to reduce wear on sail.

	A LENGTH	B LOA	C WIDTH	D PIN DIA.	PART #	PRICE
	3/4"	1"	1/2"	1/8"	#100043	\$1.60 EA
K	3/4"	1-1/8"	3/8"	1/8"	#100049*	\$2.95 EA
	1-1/16"	1-2/5"	3/8"	1/8"	#100047*	\$3.20 EA

\*Heavy Duty

### L PLASTIC INSERTS

All stainless steel shackles should be installed with a plastic insert to reduce wear on the sail. Match shackle and insert lengths for proper fit.

7/8" L #100042 \$4.95 PK10

### SNAP-IN PLASTIC SHACKLES

Self-locking snap-in pins withstand greater loads. Pip captures the sail slug to prevent shackle jamming and wear to boltrope. Works with all slugs but not stainless external slides. Requires a grommet. Width given is maximum when closed.

	A LENGTH	B LOA	C WIDTH	D PIN DIA.	PART #	PRICE
M	7/8"	1-5/8"	3/8"	5/16"	#727	\$0.70 EA
	1-1/8"	1-7/8"	1/2"	5/16"	#728	\$0.80 EA

### SCREW-ON PLASTIC SHACKLES

Secure a slug or slide to a sail. Pip prevents jamming and wear to boltrope. Easy and fast installation. Most shackles require a #1 or #2 spur grommet for installation. 11/16" Narrow is for external slides only and 5/8" Wide is for slugs only.

	A LENGTH	B LOA	C WIDTH	D PIN DIA.	PIP	PART #	PRICE
N	1-1/8"	1-3/4"	1/4"	5/16"	No	#103037	\$0.90 EA
O	15/16"	1-5/8"	5/16"	5/16"	Yes	#24106	\$0.70 EA
P	1-1/8"	1-7/8"	1/4"	5/16"	Yes	#137	\$1.15 EA
R	5/8" Wide	1"	1/8"	1/4"	No	#24105*	\$0.75 EA

\*No grommet required.

### COATED OUTHAUL SLUGS

Designed especially for use at the clews of mainsails. Aluminum alloy with Teflon coating to reduce friction. Attach with webbing.

	A DIA.	C LENGTH	PART #	PRICE
S	15/32"	2-7/8"	#23315	\$9.95 EA

### T WHITE PLASTIC HOOPS

Hoops for spars up to 1-1/2" diameter. Used on Sunfish. Snap in place. Requires a #1, #2 or #3 spur grommet (p.196).

#25101 \$3.95 PK5



### ALLSLIP SLUGS & SLIDES

Ideal for full batten applications. Slugs have round barrel. Slides have flat barrel. See p.202 for dimension descriptions.

	TYPE	A DIA.	B WAIST	C LENGTH	PART #	PRICE
	Slug	5/16"	5/32"	1-3/4"	#1138	\$5.00 EA
<b>A</b>	Slug	3/8"	5/32"	1-3/4"	#6981	\$5.00 EA
	Slug	1/2"	5/32"	1-3/4"	#1140	\$5.20 EA
	Slide	5/8"	1/4"	1-3/4"	#1131	\$5.75 EA
<b>B</b>	Slide	3/4"	3/8"	1-3/4"	#1132	\$5.75 EA
	Slide	7/8"	7/16"	1-3/4"	#1137	\$6.30 EA

### RONSTAN TRACK SLUG & SLIDE

HD glass-filled nylon slug for use on the forward edge of full length battens. Distributes the load to help eliminate jams. Acetal ball bearings are used on the forward surface to minimize friction. Secure with webbing.

	TYPE	WIDTH	LENGTH	PART #	PRICE
<b>C</b>	Slide	7/8"	2-1/2"	#4524	\$27.95 EA

## BLOCKS



### HARKEN MICRO BLOCKS

Free running, lightweight blocks with rugged stainless steel side plates. Great for use on sailboards, small dinghies and for lightly loaded control lines like traveler controls, cunninghams, outhauls, vang, barber haulers, flag halyards, lead car return tackles, and leech cords on boats of all sizes. Delrin® ball bearings ride on flat races for ultimate low load performance. **Sheave diameter: 7/8" Max line size: 1/4"**

	TYPE	BECKET	SHACKLE	LENGTH	WEIGHT	PIN DIA.	WORK LOAD	BREAK LOAD	SAILRITE (HARKEN)	PRICE
<b>A</b>	Single	No	No	1-1/2"	0.5 oz.	—	200 lb.	1,200 lb.	#224100 (224)	\$12.55 EA \$10.99 EA
<b>B</b>	Single	Yes	No	2"	0.75 oz.	—	200 lb.	1,200 lb.	#225100 (225)	\$14.20 EA \$12.99 EA
<b>C</b>	Double	No	No	2"	1.5 oz.	—	350 lb.	1,200 lb.	#120387 (226)	\$31.60 EA \$27.80 EA
<b>D</b>	Double	Yes	No	2-1/2"	1.5 oz.	—	350 lb.	1,200 lb.	#227100 (227)	\$34.15 EA \$29.99 EA
<b>E</b>	Triple	No	No	2"	2 oz.	—	500 lb.	1,200 lb.	#228100 (228)	\$45.30 EA \$39.99 EA
<b>F</b>	Triple	Yes	No	2-1/2"	2.25 oz.	—	500 lb.	1,200 lb.	#229100 (229)	\$46.35 EA \$40.99 EA
<b>G</b>	Triple/471 Carbo-Cam	No	No	2"	3.5 oz.	—	500 lb.	1,200 lb.	#230100 (230)	\$99.10 EA \$87.99 EA
<b>H</b>	Triple/471 Carbo-Cam	Yes	No	2-1/2"	3.5 oz.	—	500 lb.	1,200 lb.	#231100 (231)	\$101.00 EA \$88.99 EA
<b>I</b>	Traveler	No	No	2-3/4"	1.25 oz.	—	200 lb.	1,200 lb.	#232100 (232)	\$28.15 EA \$24.99 EA
<b>J</b>	Cheek <sup>3</sup>	No	No	2-1/2"	0.75 oz.	—	200 lb.	1,200 lb.	#120233 (233)	\$17.10 EA \$15.05 EA
<b>K</b>	Single	No	Yes	2-1/4"	0.75 oz.	3/16	200 lb.	1,200 lb.	#234100 (234)	\$18.15 EA \$15.99 EA
<b>L</b>	Single	Yes	Yes	2-3/4"	1 oz.	3/16	200 lb.	1,200 lb.	#235100 (235)	\$20.15 EA \$17.99 EA
<b>M</b>	Through-deck <sup>3</sup>	No	No	2-5/8"	1 oz.	—	200 lb.	1,200 lb.	#242100 (242)	\$30.25 EA \$26.99 EA
<b>N</b>	Upright <sup>3</sup>	No	No	1-1/2"	1 oz.	—	200 lb.	1,200 lb.	#243100 (243)	\$17.55 EA \$15.99 EA
<b>O</b>	Fiddle/V-Jam <sup>1</sup>	No	No	3-1/2"	2 oz.	3/16	350 lb.	1,200 lb.	#244111 (244)	\$37.00 EA \$32.99 EA
<b>P</b>	Fiddle/V-Jam <sup>2</sup>	Yes	No	4"	2 oz.	3/16	350 lb.	1,200 lb.	#245100 (245)	\$40.25 EA \$35.99 EA
<b>Q</b>	Single/Swivel	No	No	2-3/8"	1 oz.	5/32	200 lb.	1,200 lb.	#292111 (292)	\$25.20 EA \$22.99 EA
<b>R</b>	Forkhead	No	No	1-21/32"	0.56 oz.	—	200 lb.	1,200 lb.	#377111 (377)	\$20.35 EA \$17.99 EA
<b>S</b>	Block/eyestay assembly	No	No	1-3/4"	0.56 oz.	—	200 lb.	1,000 lb.	#443100 (443)	\$20.85 EA \$18.99 EA

<sup>1</sup>Use with 225 or 235

<sup>2</sup>Use with 226

<sup>3</sup>#10 (5mm) RH fasteners



### INTERNAL SAIL TRACK STOPS

Hold sail slides and slugs in place on the mast. Heavy-duty, black anodized aluminum and marine grade nickel plated brass. Flat stops come with lanyard holes. Turn large knurled thumb knob to move.

	WIDTH	THICK	LENGTH	PART #	PRICE
<b>E</b>	1/2" Round	-	7/8"	#3543	\$9.95 EA
<b>F</b>	7/16" Flat	1/8"	1"	#3544	\$9.95 EA
<b>G</b>	3/4" Flat	1/8"	1"	#3545	\$9.95 EA



### EXTERNAL SLIDES

Hoist the sail up and down a rolled stainless sail track with 5/8" or 7/8" external sail slides. Commonly used on traditional wooden spars.

**H** 5/8" External Slide\* #23301 \$3.30 EA

**I** 7/8" External Slide\*\* #23303 \$3.95 EA

\*Use with Shackle #24105.

\*\*Use with Shackles #100043, #100049, or #100047.



## HARKEN BULLET BLOCKS

Designed for all control applications where 3/16" to 5/16" line is used. Ideal for vang, outhauls, cunninghams, spinnaker controls, traveler controls, barber haulers, etc.

### BULLET

TYPE	BECKET	SHACKLE	SHEAVE DIA.	LENGTH	WEIGHT	PIN DIA.	MAX LINE	WORK LOAD	BREAK LOAD	SAILRITE (HARKEN)	PRICE
<b>A</b> Single	No	No	1-1/8"	2"	1 oz.	—	5/16"	300 lb.	2,000 lb.	#123082 (082)	\$16.60- <del>EA</del> \$14.99 EA
<b>B</b> Single	Yes	No	1-1/8"	2-3/4"	1.25 oz.	—	5/16"	300 lb.	2,000 lb.	#123083 (083)	\$19.90- <del>EA</del> \$17.99 EA
<b>C</b> Double	No	Yes	1-1/8"	2-3/4"	2.5 oz.	3/16"	5/16"	400 lb.	2,000 lb.	#123084 (084)	\$45.15- <del>EA</del> \$39.99 EA
<b>F</b> Triple	Yes	Yes	1-1/8"	3-3/4"	4.5 oz.	3/16"	5/16"	600 lb.	2,000 lb.	#123087 (087)	\$66.30- <del>EA</del> \$58.35 EA
<b>L</b> Cheek <sup>1</sup>	No	No	1-1/8"	2-7/8"	1.25 oz.	—	5/16"	300 lb.	2,000 lb.	#123092 (092)	\$19.70- <del>EA</del> \$17.99 EA
<b>I</b> Single/Swivel	No	Yes	1-1/8"	2-3/4"	1.5 oz.	3/16"	5/16"	300 lb.	2,000 lb.	#166100 (166)	\$29.40- <del>EA</del> \$25.99 EA
<b>J</b> Single/Swivel	Yes	Yes	1-1/8"	3-1/2"	1.75 oz.	3/16"	5/16"	300 lb.	2,000 lb.	#167100 (167)	\$32.70- <del>EA</del> \$28.99 EA

<sup>1</sup>Requires #10 RHMS (2). Hole spacing: 2-3/16" center to center.

### BIG BULLET

TYPE	BECKET	SHACKLE	SHEAVE DIA.	LENGTH	WEIGHT	PIN DIA.	MAX LINE	WORK LOAD	BREAK LOAD	SAILRITE (HARKEN)	PRICE
<b>A</b> Single	No	No	1-1/2"	2-1/2"	1.5 oz.	—	3/8"	300	2,000 lb.	#125100 (125)	\$39.25- <del>EA</del> \$26.99 EA
<b>B</b> Single	Yes	No	1-1/2"	3-1/2"	2 oz.	—	3/8"	300	2,000 lb.	#126100 (126)	\$33.75- <del>EA</del> \$29.99 EA
<b>C</b> Double	No	Yes	1-1/2"	3-1/2"	4.25 oz.	1/4"	3/8"	600	2,000 lb.	#127100 (127)	\$75.85- <del>EA</del> \$66.99 EA
<b>D</b> Double	Yes	Yes	1-1/2"	4-1/2"	4.75 oz.	1/4"	3/8"	600	2,000 lb.	#128100 (128)	\$79.35- <del>EA</del> \$69.99 EA
<b>E</b> Triple	No	Yes	1-1/2"	3-3/4"	6.5 oz.	1/4"	3/8"	750	2,000 lb.	#129100 (129)	\$109.60- <del>EA</del> \$96.99 EA
<b>F</b> Triple	Yes	Yes	1-1/2"	4-3/4"	6.75 oz.	1/4"	3/8"	750	2,000 lb.	#130111 (130)	\$113.10- <del>EA</del> \$99.99 EA
<b>G</b> Single	No	Yes	1-1/2"	3-1/8"	2 oz.	3/16"	3/8"	300	2,000 lb.	#146100 (146)	\$34.65- <del>EA</del> \$30.99 EA
<b>H</b> Single	Yes	Yes	1-1/2"	4"	2.25 oz.	3/16"	3/8"	300	2,000 lb.	#147100 (147)	\$46.40- <del>EA</del> \$35.99 EA
<b>I</b> Single/Swivel	No	Yes	1-1/2"	3-1/4"	2.25 oz.	3/16"	3/8"	300	2,000 lb.	#168100 (168)	\$39.80- <del>EA</del> \$34.99 EA
<b>J</b> Single/Swivel	Yes	Yes	1-1/2"	4"	2.5 oz.	3/16"	3/8"	300	2,000 lb.	#169100 (169)	\$43.30- <del>EA</del> \$38.10 EA

### UPRIGHT

TYPE	SHEAVE	LENGTH	WEIGHT	MAX LINE	WORK LOAD	BREAK LOAD	SAILRITE (HARKEN)	PRICE
<b>K</b> Halyard lead block	1-1/2"	2"	2.1"	3/8"	300	600	#448100 (448)	\$29.20- <del>EA</del> \$25.99 EA

Not seeing what you need? Sailrite can special order any Harken products. Call 260.244.4647 to place your order.



## HARKEN BULLET, DINGHY & EXIT BLOCKS

Designed for all control applications where 3/16" to 5/16" line is used.

### BULLET

TYPE	SHEAVE DIA.	LENGTH	WEIGHT	MAX LINE	CUTOUT	WORK LOAD	BREAK LOAD	SAILRITE (HARKEN)	PRICE
<b>M</b> Through-deck <sup>1</sup>	1-1/8"	3"	1.25 oz.	5/16"	3/4" x 1-3/4"	300 lb.	2,000 lb.	#123088 (088)	\$24.20- <del>EA</del> \$21.99 EA
<b>N</b> Upright <sup>1</sup>	1-1/8"	1-1/2"	1.5 oz.	5/16"	—	300 lb.	2,000 lb.	#123096 (096)	\$24.60- <del>EA</del> \$21.99 EA
<b>O</b> Double Upright <sup>1</sup>	1-1/8"	1-1/2"	2.25 oz.	5/16"	—	400 lb.	2,000 lb.	#220100 (220)	\$43.70- <del>EA</del> \$38.99 EA
<b>P</b> Through-deck <sup>1</sup>	1-1/8"	3"	1.25 oz.	5/16"	3/4" x 1-3/4"	300 lb.	2,000 lb.	#287100 (287)	\$36.15- <del>EA</del> \$31.99 EA
<b>Q</b> In-line exit <sup>1</sup>	1-1/8"	3-3/4"	2 oz.	5/16"	3/4" x 2-5/8"	400 lb.	2,000 lb.	#289111 (289)	\$50.80- <del>EA</del> \$44.99 EA

<sup>1</sup>5mm (#10) RH fasteners

### BIG BULLET

TYPE	SHEAVE DIA.	LENGTH	WEIGHT	MAX LINE	CUTOUT	WORK LOAD	BREAK LOAD	SAILRITE (HARKEN)	PRICE
<b>M</b> Through-deck <sup>1</sup>	1-1/2"	3-1/2"	2.25 oz.	3/8"	15/16" x 2-3/16"	300 lb.	2,000 lb.	#131100 (131)	\$39.95- <del>EA</del> \$35.15 EA
<b>R</b> In-line exit <sup>1</sup>	1-1/2"	5"	3.25 oz.	3/8"	15/16" x 3-11/16"	600 lb.	2,000 lb.	#134100 (134)	\$61.30- <del>EA</del> \$53.99 EA
<b>N</b> Upright <sup>2</sup>	1-1/2"	2-1/4"	2.5 oz.	3/8"	—	300 lb.	2,000 lb.	#222111 (222)	\$41.75- <del>EA</del> \$36.99 EA
<b>O</b> Double upright <sup>2</sup>	1-1/2"	2-1/4"	3.25"	3/8"	—	600 lb.	2,000 lb.	#223100 (223)	\$74.05- <del>EA</del> \$65.15 EA

<sup>1</sup>5mm (#10) FH fasteners

<sup>2</sup>5mm (#10) RH fasteners

## HARKEN EYESTRAPS

Harken Eyestraps are useful as light-duty mounting bases for blocks and lash-down points. They can also be used for fairleads. These forged 316 stainless steel eyestraps are strong and smooth to eliminate line chafe.



FASTENERS (not included)	A LENGTH	B LENGTH	C HEIGHT	D WIDTH	E FASTENER SPACING	F FASTENER SPACING	FITS CAM	BREAK LOAD	SAILRITE (HARKEN)	PRICE
<b>S</b> #10 RH	1-11/16"	7/16"	3/8"	7/16"	1-1/4"	—	—	1,600 lb.	#123073 (073)	\$2.25- <del>EA</del> \$1.99 EA
<b>T</b> 1/4" RH	2"	5/8"	5/8"	9/16"	1-1/2"	—	150/365	3,000 lb.	#137100 (137)	\$3.50- <del>EA</del> \$2.99 EA
<b>U</b> #10 RH	1-7/8"	9/16"	1/4"	7/16"	1-1/2"	—	150/365	1,600 lb.	#201100 (201)	\$4.60- <del>EA</del> \$3.99 PK2
<b>V</b> 1/4" RH	2-13/16"	7/8"	3/4"	5/16"	2-1/16"	—	280	3,000 lb.	#282100 (282)	\$3.75- <del>EA</del> \$3.30 EA
<b>W</b> 1/4" RH	2-1/4"	5/8"	7/16"	1-1/8"	1-3/4"	5/8"	—	6,000 lb.	#155811 (1558)	\$11.05- <del>EA</del> \$9.99 EA

## FOLDING PADEYES

Folding padeyes keep deck and passageways clear. They're ready to attach a snatch block or fender, but fold safely out of the way when not needed. Bolt-down bases and D-rings are 316 stainless steel. A vulcanized thermoplastic pad prevents rattling and holds the D-ring in position. Folding padeyes differ from conventional padeyes in that the load should be perpendicular to the hinge and bail instead of in line with it. The strongest positions are with the D-ring vertical or leaning toward the fold-down position, which focuses the load on the side anchored with two screws.

Use for:

- Loops/soft attachments
- Jacklines and tethers
- Leads
- Tie downs
- Lifting points
- Fenders

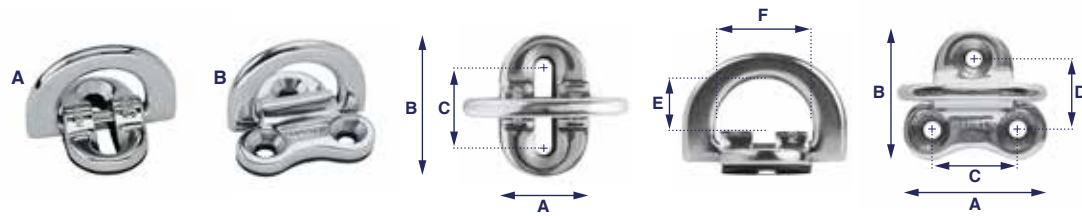

TYPE	A WIDTH	B LENGTH	C SCREW SPACING	D SCREW SPACING	E HEIGHT	F WIDTH	WORK LOAD	BREAK LOAD	FASTENERS	SAILRITE (HARKEN)	PRICE
<b>A</b> Low-load	1"	1-5/8"	7/8	—	19/32"	1-1/8"	1760 lb	3520 lb	1/4" FH	# 320611 (3206)	<del>\$35.30 EA</del> <b>\$29.99 EA</b>
<b>B</b> High-load	1-7/8"	1-5/8"	1-1/8"	15/16"	19/32"	1-1/8"	3080 lb	6160 lb	1/4" FH	#320711 (3207)	<del>\$60.65 EA</del> <b>\$53.99 EA</b>

## CAM CLEATS

### HARKEN CAM-MATIC® KITS

Kits include a cam and appropriate fairlead according to use. Wire Fairleads are for typical flat surface installations. X-treme Angle Fairleads accommodate situations where the lead to the cleat is very abrupt. Fast Release Fairleads allow for a quick flick of the line to rapidly release it with more consistent cleat disengaging. Kits indicated to have a wedge include a base that changes the angle of the cleat by 15 degrees. These include a reverse angle shim to go under the mounting surface for through-bolt applications. See Cam-Matic Ball-Bearing Cleats for detailed descriptions and uses of the various Cams p.209.



TYPE	INCLUDES CAM	WEDGE	SAILRITE (HARKEN)	PRICE
<b>C</b> Carbo-Cam/Wedge/Wire Fairlead	#423100	Yes	#120315 (472)	<del>\$38.25 EA</del> <b>\$33.99 EA</b>
<b>E</b> Cam-Matic/Wire Fairlead	#338100	No	#469111 (469)	<del>\$36.85 EA</del> <b>\$32.99 EA</b>
<b>D</b> Carbo-Cam/Wire Fairlead	#423100	No	#120427 (473)	<del>\$33.30 EA</del> <b>\$29.99 EA</b>
<b>H</b> Carbo-Cam/X-treme Angle Fairlead	#423100	No	#474123 (474)	<del>\$42.00 EA</del> <b>\$36.99 EA</b>
<b>I</b> Cam-Matic/X-treme Angle Fairlead	#338100	No	#470100 (470)	<del>\$45.55 EA</del> <b>\$39.99 EA</b>
<b>G</b> Cam-Matic/Fast Release Fairlead	#338100	No	#498100 (498)	<del>\$45.55 EA</del> <b>\$39.99 EA</b>
<b>F</b> Carbo-Cam/ Fast Release Fairlead	#423100	No	#499100 (499)	<del>\$42.00 EA</del> <b>\$36.99 EA</b>

TYPE	INCLUDES CAM	WEDGE	SAILRITE (HARKEN)	PRICE
<b>D</b> Carbo-Cam/Wire Fairlead	#365100	No	#120326 (326)	<del>\$38.70 EA</del> <b>\$34.05 EA</b>
<b>E</b> Cam-Matic/Wire Fairlead	#115011	No	#120327 (327)	<del>\$46.40 EA</del> <b>\$40.85 EA</b>
<b>H</b> Carbo-Cam/X-treme Angle Fairlead	#365100	No	#458100 (458)	<del>\$46.55 EA</del> <b>\$40.99 EA</b>
<b>I</b> Cam-Matic/X-treme Angle Fairlead	#115011	No	#459100 (459)	<del>\$54.25 EA</del> <b>\$47.99 EA</b>
<b>G</b> Cam-Matic/Fast Release Fairlead	#115011	No	#496100 (496)	<del>\$54.25 EA</del> <b>\$47.99 EA</b>
<b>F</b> Carbo-Cam/Fast Release Fairlead	#365100	No	#497100 (497)	<del>\$46.55 EA</del> <b>\$40.99 EA</b>

Not seeing what you need? Sailrite can special order any Harken products. Call 260.244.4647 to place your order.

## HARKEN CAM-MATIC® BALL-BEARING CLEATS

It's hard to match Harken Cam-Matic cleats in performance and durability. Multiple rows of high load ball bearings reduce friction so cams open easily for snap-down cleating. Lines engage with a simple downward pressure and release with a flick or light pull even when under the heaviest loads.

Holds all types of line (small, hard, high-tech, and soft large lines) with equal force and the same number of teeth. Rounded teeth do not damage lines. Round, die-cast aluminum jaws are Hardcoat anodized with a slippery Teflon impregnation to resist line abrasion.

Use for continuous adjustment applications. For racing, select from the lightweight fiber-reinforced Carbo-Cams. Double Cam-matic cleats hold two lines for situations where space is tight.



TYPE	LINE SIZE	HEIGHT	LENGTH	WIDTH	WORK LOAD	PAWLS	FASTENERS (SPACING)	SAILRITE (HARKEN)	PRICE
Micro Carbo-Cam®	1/8" – 1/4"	7/8"	1-7/8"	15/16"	150 lb.	Plastic/Carbon	2 - #8 FHMS (1-1/16")	#423100 (471)	<del>\$26.10 EA</del> <b>\$22.99 EA</b>
Micro Cam-Matic®	3/32" – 1/4"	7/8"	1-7/8"	15/16"	200 lb.	Aluminum	2 - #8 FHMS (1-1/16")	#338100 (468)	<del>\$29.65 EA</del> <b>\$25.99 EA</b>
Standard Carbo-Cam®	1/8" – 3/8"	1-3/16"	2-9/16"	1-1/4"	200 lb.	Plastic/Carbon	2 - #10 FHMS (1-1/2")	#365100 (365)	<del>\$28.65 EA</del> <b>\$25.99 EA</b>
Standard Cam-Matic®	1/8" – 1/2"	1-3/16"	2-9/16"	1-1/4"	300 lb.	Aluminum	2 - #10 FHMS (1-1/2")	#115011 (150)	<del>\$36.35 EA</del> <b>\$31.99 EA</b>
Offshore Cam-Matic®	1/4" – 5/8"	1-7/16"	3-3/8"	1-1/2"	500 lb.	Aluminum	2 - 1/4" FHMS (2-1/16")	#102801 (280)	<del>\$57.20 EA</del> <b>\$50.99 EA</b>
Standard Double Cam-Matic	5/16" – 3/8"	2-1/16"	3-17/32"	1-1/4"	500 lb.	Aluminum	2 - #10 FHMS (2-7/16")	#412100 (412)	<del>\$87.25 EA</del> <b>\$76.99 EA</b>



### GRANSEGEL CLEATS

Plastic cleats sandwich the leech and protect the line openings in a sail. Excellent for use on jib sails where flat profile prevents snagging when the sail rubs over the stay. Hand sew in place with waxed twine.

Small, 1/16"–5/64" Leech line  
#22205 **\$2.95 EA**

Large, 5/64"–5/32" Leech line  
#22206 **\$2.95 EA**

XL, 1/8"–5/32" Leech line  
#103349 **\$4.00 EA**

### METAL CLAMCLEAT

Best used on the port side of mainsails and headsails where there is no chance of snagging on the rigging. Very durable and great for large boats and tropical conditions. Hand sew in place with waxed twine.

#2359 **\$10.25 EA**

### VERTICAL CLAMCLEAT

Quickly and easily adjust control lines. High strength black plastic vertical clamcleat with fairlead channel. Tapered grooves ensure grip without wear. Use with up to 5/16" line. Length: 3-1/4". Hole spacing: 2-5/8".

#103403 **\$4.95 EA**

### LARGE PLASTIC CLOSED CLAMCLEAT

Use on either side of the sail with 1/8" or 5/32" leech line. Use center punch to install. Back plate and brass rivets included. Shield sold separately.

**A** Clamcleat #23202 **\$5.95 EA**

**B** Shield #23205 **\$1.95 EA**



### SAIL LINE CLEAT

Use on jib sails with 5/64" or 1/8" line. Does not snag. Plastic cleat. Hand sew in place with waxed twine.

#23204 **\$4.50 EA**

### SMALL PLASTIC CLOSED CLAMCLEAT

Use on jib sails with 1/16" or 5/64" leech line. Closed construction prevents snagging. Use center punch to install. Back plate and rivets included.

#23203 **\$2.95 EA**

### RONSTAN CLEAT

Similar to a metal clamcleat but constructed from plastic so it is less expensive and lighter. Use center punch to install. Back plate and rivets included.

#54673A **\$10.25 EA**

# RIGGING SHACKLES

Rigging shackles are used for a variety of applications in sail rigging. Use the shackles found here for lifting bridles, securing blocks, topping lifts, genoa sheets, jib or spinnaker halyard ends and much more. Select a swivel shackle when more articulation and rotation is desired.

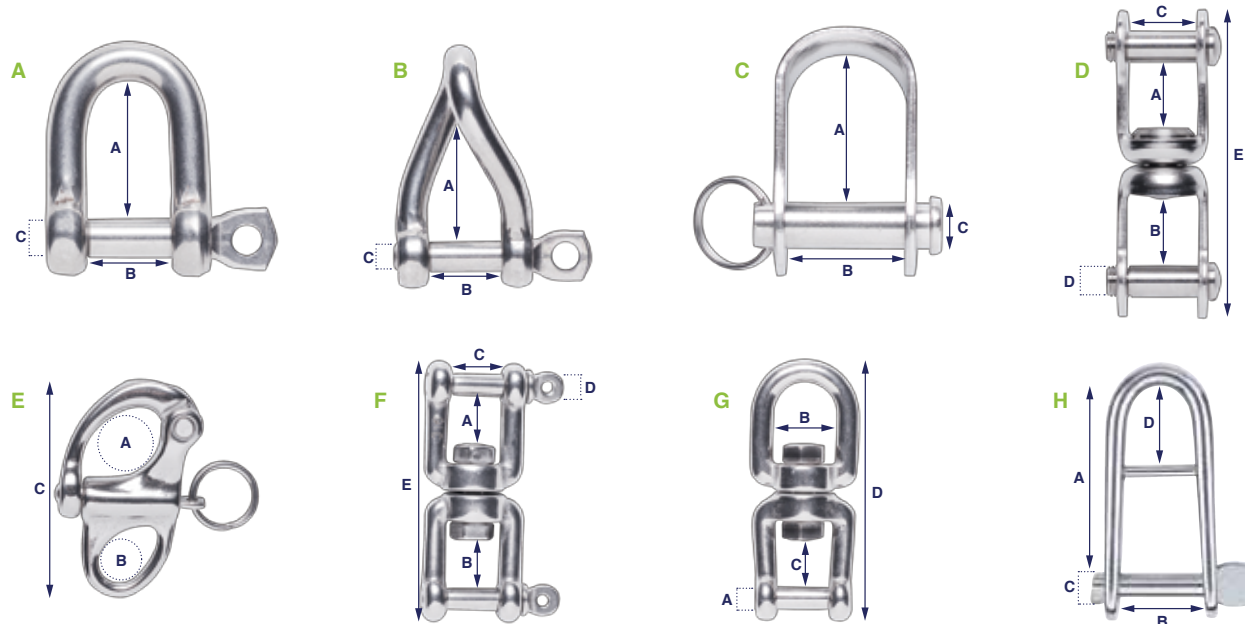

## HARKEN FORGED D SHACKLES

Replacement shackles for 2.25 Harken blocks and larger. Also strong enough for lifting bridles. Electric-forged 316 and 17-4PH stainless steel. Polished to high luster.

A HEIGHT	B WIDTH	C PIN DIA.	WORK LOAD	BREAK LOAD	SAILRITE (HARKEN)	PRICE
3/4"	9/16"	1/4"	1,650 lb.	3,300 lb.	#122108 (2108)	\$13.00 EA \$11.99 EA
1"	11/16"	5/16"	3,040 lb.	6,080 lb.	#122115 (2115)	\$19.35 EA \$16.15 EA
<b>A</b> 1-1/4"	13/16"	13/32"	4,870 lb.	9,740 lb.	#122122 (2122)	\$26.45 EA \$23.30 EA

## HARKEN TWIST SHACKLES

Great as tack shackles and for extending sail corner grommet reach. Electric-forged 316 and 17-4PH stainless steel. Polished to high luster. Perpendicular orientation of attachment.

A HEIGHT	B WIDTH	C PIN DIA.	WORK LOAD	BREAK LOAD	SAILRITE (HARKEN)	PRICE
1-7/16"	3/8"	3/16"	1,190 lb.	2,380 lb.	#122105 (2105)	\$12.05 EA \$10.99 EA
<b>B</b> 1-1/8"	1/2"	1/4"	1,650 lb.	3,300 lb.	#122112 (2112)	\$14.35 EA \$12.99 EA
1-5/8"	11/16"	5/16"	3,040 lb.	6,080 lb.	#122119 (2119)	\$24.55 EA \$21.99 EA

## HARKEN SHACKLE STAMPED STAINLESS STEEL

Stamped stainless steel shackles used on most small boat blocks. Useful for a variety of different applications.

SIZE	A HEIGHT	B WIDTH	C PIN DIA.	WORK LOAD	BREAK LOAD	SAILRITE (HARKEN)	PRICE
Micro	7/16"	3/8"	5/32"	600 lb.	1,200 lb.	#123246 (246)	\$4.40 EA \$3.99 EA
Small	1/2"	7/16"	3/16"	1,250 lb.	2,500 lb.	#123072 (072)	\$4.50 EA \$3.99 EA
Medium	5/8"	9/16"	1/4"	1,500 lb.	3,000 lb.	#276111 (2761)	\$7.25 EA \$6.99 EA
<b>C</b> Large	11/16"	5/8"	1/4"	1,500 lb.	3,000 lb.	#123138 (138)	\$7.25 EA \$6.99 EA

## CAPTIVE HALYARD SHACKLE

Forged 316 stainless steel shackle with a secondary pin to keep the shackle permanently secured to a halyard and oriented properly. Can also be used as an outhaul shackle

A HEIGHT	B WIDTH	C PIN DIA.	D HEIGHT	WORK LOAD	BREAK LOAD	SAILRITE (HARKEN)	PRICE
<b>H</b> 1-3/8"	9/16"	3/16"	9/16"	1,190 lb.	2,380 lb.	#210711 (2107)	\$28.80 EA \$25.99 EA

## RONSTAN SWIVEL SHACKLE

Use in conjunction with blocks and rigging systems to provide articulation and rotation. Ball bearing swivel construction provides lower friction and higher working loads than non-ball bearing versions. Complete grade 316 stainless steel constructions.

A LENGTH	B LENGTH	C WIDTH	D PIN DIA.	E LOA	WORK LOAD	BREAK LOAD	PART #	PRICE
<b>D</b> 5/8"	5/8"	21/32"	5/16"	3"	4,630 lb.	5,071 lb.	#103566	\$37.95 EA

## SUNCOR FIXED EYE SNAP SHACKLES

Use fixed eye shackles for topping lifts, genoa sheets, and non-twisting applications. Sailrite uses #103748 for Safety Tethers (p.244).

A HOOK DIA.	B EYELET DIA.	C LOA	FUNCTIONAL	BREAK LOAD	PART #	PRICE
<b>E</b> 9/16"	7/16"	2"	1,000 lb.	4,000 lb.	#103747	\$12.95 EA
3/4"	1/2"	2-5/8"	1,500 lb.	6,000 lb.	#103748	\$15.95 EA
1-1/16"	11/16"	3-3/4"	2,000 lb.	8,000 lb.	#103749	\$28.95 EA

## SUNCOR DOUBLE PIN SWIVEL SHACKLES

Use in rigging and other applications where a twist in cable, rope or cord is undesirable. Heavy-duty precision cast, 316 stainless steel.

A LENGTH	B LENGTH	C WIDTH	D PIN DIA.	E LOA	WORK LOAD	BREAK LOAD	PART #	PRICE
<b>F</b> 7/16"	7/16"	1/2"	1/4"	2-1/2"	600 lb.	2,400 lb.	#103750	\$7.95 EA
5/8"	5/8"	5/8"	5/16"	3-1/2"	1,100 lb.	4,400 lb.	#103751	\$12.95 EA
7/8"	7/8"	3/4"	3/8"	4.5"	1,540 lb.	6,160 lb.	#103752	\$19.95 EA

## SUNCOR EYE & JAW SWIVEL

Use with blocks and rigging systems to provide articulation and rotation. Heavy-duty, grade 316 precision cast construction. Use of thread locking fluid is recommended.

A PIN DIA.	B WIDTH	C LENGTH	D LOA	WORK LOAD	PART #	PRICE
<b>G</b> 1/4"	9/16"	7/16"	2-5/8"	600 lb.	#103775	\$6.95 EA
5/16"	3/4"	5/8"	3-5/8"	1,100 lb.	#103774	\$10.95 EA
3/8"	15/16"	7/8"	4-3/8"	1,540 lb.	#103773	\$16.95 EA

## RECMAR PLASTREAM SAIL BATTENS

The most asked for battens in the world! Unbreakable, non-tapered plastic battens for the perfect sail shape. Easy to cut and file to the perfect size. Unlike fiberglass, these ABS Cyclocac® plastic battens will not splinter fingers or sails and do not require end caps.

#103325 SEE CHART, SELECT BATTEN WIDTH AND BATTEN LENGTH

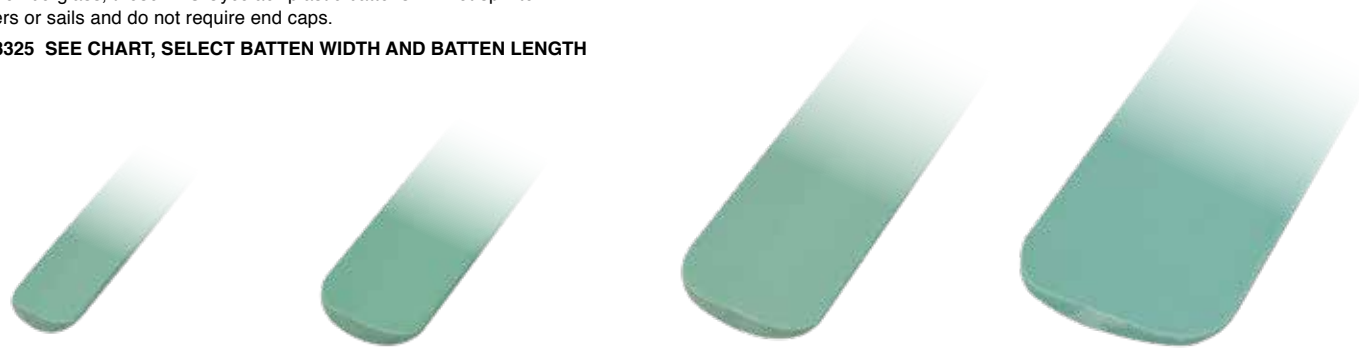

### 5/8" WIDTH

8" Length	\$2.25 EA
12" Length	\$2.25 EA
15" Length	\$3.75 EA
18" Length	\$4.10 EA
21" Length	\$4.40 EA
24" Length	\$4.70 EA
27" Length	\$5.05 EA
30" Length	\$5.20 EA
36" Length	\$5.80 EA
40" Length	\$6.15 EA

### 1" WIDTH

8" Length	\$3.55 EA
12" Length	\$3.95 EA
15" Length	\$4.40 EA
18" Length	\$4.70 EA
21" Length	\$5.50 EA
24" Length	\$5.80 EA
27" Length	\$6.25 EA
30" Length	\$6.75 EA
36" Length	\$7.65 EA
40" Length	\$8.30 EA

### 1-3/8" WIDTH

8" Length	\$3.90 EA
12" Length	\$4.65 EA
15" Length	\$5.15 EA
18" Length	\$5.65 EA
21" Length	\$6.45 EA
24" Length	\$7.15 EA
27" Length	\$7.65 EA
30" Length	\$8.25 EA
36" Length	\$9.85 EA
40" Length	\$10.10 EA

### 2" WIDTH

8" Length	\$5.50 EA
12" Length	\$6.30 EA
15" Length	\$6.90 EA
18" Length	\$8.10 EA
21" Length	\$9.10 EA
24" Length	\$10.25 EA
27" Length	\$11.50 EA
30" Length	\$12.30 EA
36" Length	\$14.40 EA
40" Length	\$15.45 EA

## RBS TAPERED E-GLASS BATTENS

These tapered battens are made from an RBS proprietary fiberglass called "E-Glass" that's extremely durable and virtually unbreakable. The flex taper allows these battens to conform to the shape of the sail without causing hard spots. Inner end cap comes pre-installed. Outer end caps are not needed. Can be shortened with a hacksaw.



### A 3/4" WIDTH BATTEN

For both compression and leech battens in mains and jibs for larger boats, 30 feet and over

31-1/2" Length Batten #120665 \$21.95 EA  
 35-1/2" Length Batten #120667 \$24.95 EA  
 43-1/4" Length Batten #120668 \$33.95 EA  
 47-1/4" Length Batten #120669 \$35.95 EA  
 63" Length Batten #120670 \$51.95 EA

### C 5/8" WIDTH BATTEN

For displacement boats from 18-30 feet

23-1/2" Length Batten #120622 \$13.95 EA  
 30" Length Batten #120662 \$16.95 EA  
 35-1/2" Length Batten #120663 \$18.95 EA  
 47-1/4" Length Batten #120664 \$27.95 EA

### B 3/8" WIDTH BATTEN

For Dinghies and smaller One Design classes, typically under 20-feet

12" Length Batten #120658 \$5.95 EA  
 18" Length Batten #120659 \$6.95 EA  
 23-1/2" Length Batten #120621 \$9.95 EA  
 30" Length Batten #120660 \$12.95 EA  
 35-1/2" Length Batten #120661 \$13.95 EA



## BATTEN POCKET END PROTECTORS

Keep batten ends from poking through the sail at the luff. Fits any flat batten like our pultruded or tapered battens. Heavy duty, slotted nylon protectors (#33331, #64822 & #42522) fit up to 1" webbing and allow sail slides to be webbed directly onto the protector to create less friction against the mast. Screws included.

USE WITH	PART #	PRICE
I 5/8" Battens (self-tapping screws)	#27204	\$1.45 EA
J Up to 1-1/2" Battens (machine screws)	#27205	\$2.20 EA
K Up to 1-1/4" Battens	#33331	\$4.60 EA
L Up to 1-5/8" Battens	#42522	\$9.10 EA

## PULTRUDED BATTENS & END CAPS

Pultruded, non-tapered, fiberglass-reinforced plastic battens. Heavy duty grade assures all sizes are adequate for the most demanding sail applications. Easily cut and sanded for variable flexibility. End caps protect the sail from delaminating fiberglass batten ends. Injection molded nylon.

Lengths greater than 8 feet will arrive coiled, please use caution when unpacking as they are under a great deal of pressure.

### 5/8" WIDTH (N)

LENGTH	PART #	PRICE
2' Length	#121156	\$4.95 EA
3' Length	#121157	\$6.95 EA
5' Length	#121158	\$11.95 EA
8' Length	#121159	\$18.95 EA
15' Length	#121180	\$33.95 EA

### 1" WIDTH (O)

LENGTH	PART #	PRICE
2' Length	#121146	\$5.95 EA
3' Length	#121147	\$8.95 EA
5' Length	#121148	\$14.95 EA
8' Length	#121149	\$22.95 EA
22' Length	#27116	\$62.95 EA

P 5/8" End Cap #27201 \$0.95 PK2

Q 1" End Cap (tight stretch fit) #27202 \$1.95 PK2



### CATAMARAN BATTEN END CAP

For 1" pultruded, non-tapered, fiberglass-reinforced plastic catamaran batten. Fits over ridge and has a hole and jam slot for tying in place.

#523211 \$5.95 PK2



### POCKET ELASTIC

Great for batten pockets and elastic webbing safety tethers. Sew on the front of batten pockets to increase tension and secure battens all the way aft, reducing the tendency of the leech to flutter.

1" White #22202 \$0.35 FT

2" White #68911 \$0.55 FT



# JIB SAIL ATTACHMENTS

Jibs can be secured to the wire forestay with either jib snaps or hanks. Jib snaps lock positively over the stay with a sliding piston that closes a hooked end. Often #2 spur grommets (p.196) are required for installation. Install the grommet just behind the luff reinforcement in the sail.

Hanks are simple and inexpensive but lack the strength or surety required for larger boats (can come off the stay when lowering sail). Used primarily on day sailing boats under 20 feet. Twist in place by turning sideways, pushing over the stay, and turning upright.

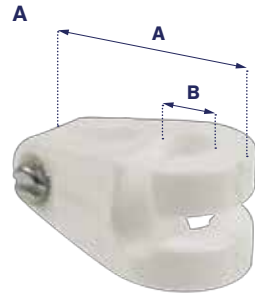

## A HOLT ALLEN NYLON SAIL HANKS

For boats under 20 feet. Install by inserting screw into the plastic 'ear' that fits over and behind the luff reinforcement. Includes screw (soap before installation to reduce breakage). Grommets not required.

A LENGTH	B WIRE DIA.	PART #	PRICE
1-1/4"	< 1/8"	#24101	\$0.80 EA
1-3/8"	< 3/16"	#24102	\$1.20 EA

## B RONSTAN NYLON PISTON SNAPS

Great for drifters! Install by inserting screws into plastic 'ears' that fit over and behind the luff reinforcement. Includes screws (soap before installation to reduce breakage). Grommets not required.

SIZE	A LENGTH	B WIRE DIA.	PART #	PRICE
#1	2"	< 1/4"	#45242	\$10.95 EA
#2	2-1/2"	< 5/16"	#23525	\$12.95 EA
#3	3"	< 7/16"	#24221	\$14.95 EA

## C PRESS-ON SWEDISH SNAPS

Use with spur grommet (match grommet size with snap size). Bend long arm into place gradually with a mallet to prevent breakage. Partner with a plastic insert to reduce wear on the sail. Inserts sold separately.

SIZE	A LENGTH	B WIRE DIA.	PART #	PRICE
#0	1-3/4"	< 1/4"	#24305	\$6.00 EA
#1	2-1/16"	< 5/16"	#24306	\$8.25 EA
#2	2-1/2"	< 7/16"	#24307	\$8.55 EA
#3	2-7/8"	< 5/8"	#24308	\$9.75 EA
D	Plastic Insert for #0 & #1 Snap		#100001	\$2.95 PK10
E	Plastic Insert for #2 Snap		#100206	\$2.95 PK10
F	Plastic Insert for #3 Snap		#100208	\$2.95 PK10

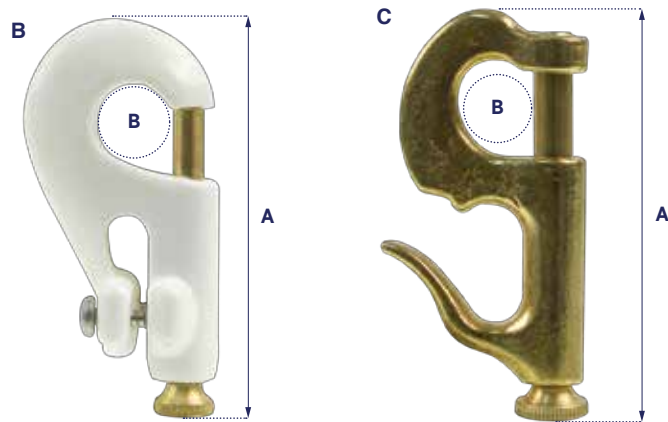

# THIMBLES

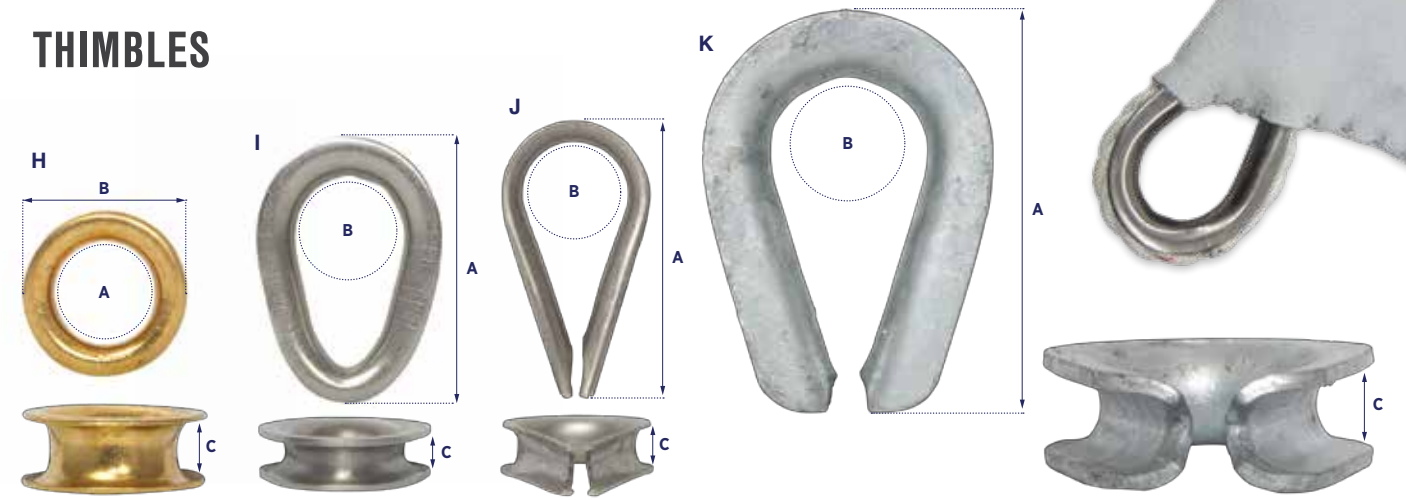

## H BRASS THIMBLES

Traditional grommet choice for inserting in a rope eye. Also used for jacklines.

A I.D.	B O.D.	C SCORE	PART #	PRICE
1/4"	1/2"	1/4"	#563	\$1.85 EA
3/8"	5/8"	1/4"	#609	\$2.05 EA
5/8"	1"	3/8"	#29405	\$3.80 EA
3/4"	1-1/4"	3/8"	#26106	\$4.45 EA

## I SOLID STAINLESS STEEL THIMBLES

Best used as inserts for rope/wire eyes to prevent thread from slipping through the throat when whipping to a sail corner. Heavy, well made, and able to take the high stress loads of a taut foresail luff.

A LENGTH	B I.D.	C WIRE DIA.	PART #	PRICE
1-7/16"	11/16"	3/16"	#100341	\$5.25 EA
1-7/8"	3/4"	1/4"	#100342	\$5.45 EA
2-1/4"	1"	5/16"	#100343	\$9.65 EA

## J SPLIT STAINLESS STEEL THIMBLES

Use as inserts for wire and rope eyes. Very heavy and well made.

A LENGTH	B I.D.	C WIRE DIA.	PART #	PRICE
1"	5/16"	1/16"-1/8"	#26201	\$0.60 EA
1-1/2"	1/2"	5/32"-3/16"	#26202	\$1.40 EA
2"	11/16"	7/32"-1/4"	#26203	\$1.65 EA

## K WIRE / ROPE THIMBLE

Hot dipped galvanized thimble for use in drogues.

A LENGTH	B I.D.	C WIRE DIA.	PART #	PRICE
3-1/4"	1-3/4"	5/8"	#3495	\$7.35 EA

## SISTER CLIP

Allows for fast and positive sheet attachment to a sail. Use on one-design or light air spinnakers. Stainless steel with ferrule. Length: 1-1/2".

#100366 \$8.95 EA



# SWAGE-IT RIGGING KIT

Prepare for emergency repairs on rigging and Nicopress sleeves on cables. To install sleeve, insert two parts of wire through the sleeve and squeeze together with the installation tool. Select sleeve size according to wire's outside diameter.

Nicopress Installation Tool: Strong, durable alloy steel 8 bolt tool. Heat treated for long life. Pre-lubed for working ease. Tighten bolt to close tool bars.

Cable cutters: Clean cuts with no frayed ends. Aircraft quality alloy steel. Heat treated for long life. Plated for maximum rust protection. Unique handle design for comfort.

Nicopress Sleeves: Hollow zinc-plated copper sleeves for making eye splices in wire.

## KIT INCLUDES:

#316 cable cutter I, #2 Nicopress installation tool (1/16", 3/32" and 1/8" sleeves) K, 1/2" combination wrench J, 10 - 1/16" sleeves, 10 - 3/32" sleeves, 5 - 1/8" sleeves, and clear plastic storage tube with vinyl caps.

Swage-It Rigging Kit #103103 \$78.95 KIT

## À LA CARTE

K Nicopress Installation Tool #19203 \$30.95 EA

L 1/16" Nicopress Sleeve #23101 \$0.20 EA

M 3/32" Nicopress Sleeve #23102 \$0.50 EA

N 1/8" Nicopress Sleeve #23103 \$1.00 EA



# NEW POLYFORM FENDERS & BUOYS

Protect your boat with high quality fenders and buoys from Polyform US. Find just the right size and style fender or buoy for rafting and docking your vessel. All Polyform fenders and buoys are constructed with even wall thicknesses for the maximum strength and durability. Polyform's unique valve system requires an Inflation Adapter (p.217) for inflation.



Pictured: Polyform HTM-4 #120999

## POLYFORM G SERIES FENDERS

Polyform's most popular utility fender! A standard fender on small boats, the G Series features molded-in ribs for strength and abrasion resistance. Reinforced rope holds. Hangs vertically or horizontally. Use for trailered boats and in permanent protected moorings. Ships partially inflated. Available in black, white and blue.

G-SERIES	MODEL	COLOR	LENGTH	DIA.	EYE DIA.	MAX CIRC.	VOLUME	WEIGHT	BOAT SIZE	PART#	PRICE
	G-3	Black	19"	5.5"	0.625"	17.3"	1.4 gal.	1.9 lb.	15'-20'	#121001	\$15.95 EA
	G-3	Blue	19"	5.5"	0.625"	17.3"	1.4 gal.	1.9 lb.	15'-20'	#121002	\$15.95 EA
	G-3	White	19"	5.5"	0.625"	17.3"	1.4 gal.	1.9 lb.	15'-20'	#120990	\$15.95 EA
	G-4	Black	22'	6.5"	0.75"	20.4"	2.2 gal.	2.6 lb.	20'-25'	#121004	\$23.95 EA
	G-4	Blue	22'	6.5"	0.75"	20.4"	2.2 gal.	2.6 lb.	20'-25'	#121006	\$23.95 EA
	G-4	White	22'	6.5"	0.75"	20.4"	2.2 gal.	2.6 lb.	20'-25'	#121003	\$23.95 EA
	G-5	Black	26.8"	8.8"	0.75"	27.7"	5.1 gal.	4.4 lb.	25'-35'	#121008	\$38.21 EA
	G-5	Blue	26.8"	8.8"	0.75"	27.7"	5.1 gal.	4.4 lb.	25'-35'	#121009	\$38.21 EA
	G-5	White	26.8"	8.8"	0.75"	27.7"	5.1 gal.	4.4 lb.	25'-35'	#121007	\$45.95 EA

## POLYFORM HTM SERIES FENDERS

The HTM series features a hole through the middle that allows fenders to hang vertically or horizontally. Classic tube design features molded-in ribs for extra protection. Tube ends are reinforced to prevent lines from pulling through. Designed for medium-duty use in both permanent protected and unprotected moorings. Also useful against pilings and other awkward docking situations. Ships partially inflated.

HTM SERIES	MODEL	COLOR	LENGTH	DIA.	TUBE DIA.	MAX CIRC.	VOLUME	WEIGHT	BOAT SIZE	PART#	PRICE
	HTM-2	Black	20.5"	8.5"	0.625"	26.7"	4.7 gal.	4.7 lb.	20'-30'	#120996	\$49.95 EA
	HTM-2	White	20.5"	8.5"	0.625"	26.7"	4.7 gal.	4.7 lb.	20'-30'	#120989	\$49.95 EA
	HTM-3	Black	27"	10.5"	0.625"	33"	9.2 gal.	7.7 lb.	30'-40'	#120998	\$80.95 EA
	HTM-3	White	27"	10.5"	0.625"	33"	9.2 gal.	7.7 lb.	30'-40'	#120997	\$80.95 EA
	HTM-4	Black	34.8"	13.5"	0.625"	42.4"	15.6 gal.	10.5 lb.	40'-50'	#121000	\$118.95 EA
	HTM-4	White	34.8"	13.5"	0.625"	42.4"	15.6 gal.	10.5 lb.	40'-50'	#120999	\$118.95 EA

## POLYFORM F SERIES FENDER

Polyform's best-selling heavy-duty fender. Unique, one-piece construction provides the best in durability and strength. Twin-eye design allows for hanging both vertically and horizontally. Ribbed reinforced rope holds. Designed for use in permanent unprotected moorings, pilings, locks and concrete walls. Ships deflated.

F-SERIES	MODEL	COLOR	LENGTH	DIA.	EYE DIA.	MAX CIRC.	VOLUME	WEIGHT	BOAT SIZE	PART#	PRICE
	F-7	Black	41"	15"	1"	47.1"	18.8 gal.	10.6 lb.	40'-60'	#120991	\$167.95 EA

## POLYFORM A SERIES BUOY

The #1 buoy in the world! Time-tested to hold up in the most extreme conditions. Commonly used as a marker or mooring buoy, but also a great choice as a rafting fender. Bright red for excellent visibility. Ships deflated.

A-SERIES	MODEL	COLOR	LENGTH	DIA.	EYE DIA.	MAX CIRC.	VOLUME	WEIGHT	BOAT SIZE	PART#	PRICE
	A-2	Red	19.5"	14.5"	1.125"	45.6"	8.2 gal.	4.4 lb.	20'-40'	#120988	\$45.95 EA
	A-3	Red	23"	17"	1.125"	53.4"	14.5 gal.	6.8 lb.	40'-50'	#120993	\$61.95 EA
	A-4	Red	27"	20.5"	1.125"	64.4"	22.5 gal.	9.5 lb.	50'-60'	#120994	\$81.95 EA

## NEW POLYFORM MINI PUMP FOR BUOYS AND FENDERS

Use this small hand pump with the Polyform Inflation Adapter (sold separately) to quickly and easily add air into Polyform buoys and fenders. Length: 6 inches.

**A #120987 \$8.95 EA**

## NEW POLYFORM INFLATION ADAPTER FOR BUOYS AND FENDERS

This inflation adapter is a necessity to properly inflate all Polyform buoys and fenders with valves. Adapter fits on any hand pump, small electric air compressor, or gas station air hose.

**B #120986 \$0.50 EA**







## NEW ENGLAND ROPES

Since 1967 New England Ropes, Inc. has built and maintained its reputation as the leading manufacturer of premium quality rope, proudly servicing more markets than any other rope company. Made in New England, it's the most innovative product available, woven from the finest first-class fibers and designed and tested in a place with some of the world's most notoriously harsh conditions. Not only do New England Ropes feel smoother, perform better, and last longer, they are guaranteed to be completely free of manufacturing defects.

FIBER TYPE	STRENGTH	STRETCH	UV RESISTANCE	COST
Nylon	High	High	Good	\$\$
Polyester	High	Low	Good	\$\$
HMPE	Very High	Very Low	Good	\$\$\$
Aramid	Very High	Very Low	Fair	\$\$\$
LCP	Very High	Very Low	Fair	\$\$\$
Polypropylene	Low	High	Poor	\$

### ROPE SIZE & SELECTION RECOMMENDATIONS p.250

Determine which rope material, size, and length is best for your boat.

### CHOOSING THE CORRECT LINE p.250

Determine the best line type and diameter for a given application.

### CONSTRUCTION:

- **Double Braid:** Strong, durable, easy-to-handle rope consisting of a braided core inside a braided cover. Ideal for running rigging and dock lines.
- **Parallel Core:** Patented unidirectional fiber core with braided cover that has significantly less stretch and greater strength than comparable double braid lines. Ideal for halyards, sheets, and guys where low stretch is required.
- **Single Braid:** Flexible, soft rope construction that absorbs twist and does not kink. Perfect for mainsheets, furling lines, and large dock lines.
- **3 Strand:** Durable, long-lasting, flexible, and easy-to-handle rope developed from a special stabilization process and 4-stage balanced construction. Ideal for anchor, dock, mooring and tow lines, and for running rigging on traditional cruising boats.

### MATERIALS:

- **NYLON:** Use for applications where strength and shock absorption are important, such as dock and anchor lines.
- **POLYESTER:** Use where strength, low stretch, and durability are key, like most running rigging applications.
- **HMPE, ARAMIDS & LCP** (Dyneema®, Kevlar® & Vectran®): Use where very high performance line with very high strength and extremely low stretch is needed, such as serious racing sailboats and larger yachts.
- **POLYPROPYLENE:** Use where lightweight or low cost is important, such as light air spinnaker sheets or barrier rope for swimming.

## STA-SET X™

The strongest and lowest stretch polyester line available! Patented parallel fiber core and braided cover made from a blend of spun and filament polyester. Good grip and easy handling. Fully spliceable. Use for rope halyards, sheets, after-guy, and other low stretch, high strength applications.



DIAMETER	COLOR	TENSILE (LB)	PART #	PRICE
1/4" (6 mm)	Red	2,700	#1439	\$0.70/FT
1/4" (6 mm)	Green	2,700	#1440	\$0.70/FT
1/4" (6 mm)	Blue	2,700	#1441	\$0.70/FT
5/16" (8 mm)	Red	4,400	#1442	\$0.95/FT
5/16" (8 mm)	Green	4,400	#1443	\$0.95/FT
5/16" (8 mm)	Blue	4,400	#1444	\$0.95/FT
3/8" (10 mm)	Red	5,500	#1445	\$1.15/FT
3/8" (10 mm)	Green	5,500	#1446	\$1.15/FT
3/8" (10 mm)	Blue	5,500	#1447	\$1.15/FT
7/16" (11mm)	Red	7,700	#120075	\$1.45/FT
7/16" (11mm)	Green	7,700	#120076	\$1.45/FT
7/16" (11mm)	Blue	7,700	#120077	\$1.45/FT
1/2" (12mm)	Red	9,700	#120078	\$1.90/FT
1/2" (12mm)	Green	9,700	#120079	\$1.90/FT
1/2" (12mm)	Blue	9,700	#120080	\$1.90/FT

## REGATTA BRAID™

Single braid 12-strand polyester. Soft, runs freely, and does not kink. Use for main sheets and furling lines. White with red tracer.



DIAMETER	COLOR	TENSILE (LB)	PART #	PRICE
1/4" (6 mm)	White	2,550	#103217	\$0.50/FT
5/16" (8 mm)	White	3,300	#239100	\$0.70/FT
3/8" (10 mm)	White	4,800	#240100	\$0.90/FT
7/16" (11mm)	White	6,500	#120071	\$1.10/FT

## REGATTA LITE™

Lightweight, braided polypropylene line. Perfect for flag halyards, small boat main sheets and control lines, and non-critical control lines on larger boats. Does not absorb water and floats indefinitely. Kink-free.



DIAMETER	COLOR	TENSILE (LB)	PART #	PRICE
1/4" (6 mm)	Teal	1,050	#21101	\$0.40/FT
3/8" (10 mm)	Yellow	3,200	#21103	\$0.70/FT

## #1 Double-Braided Line in America

## STA-SET™



Strong, extremely flexible, long-wearing double braided polyester line. Ideal for all types of running rigging like sail sheets, furling lines, etc. Special tension setting process removes residual elongation and adds dimensional stability. Easy to handle and splice (inner and outer core). Conforms to physical requirements of Mil-R-24677.

DIAMETER	COLOR	TENSILE (LB)	PART #	PRICE
3/16" (5 mm)	White	1,300	#290	\$0.40/FT
3/16" (5 mm)	White/Red	1,300	#1452	\$0.45/FT
3/16" (5 mm)	White/Blue	1,300	#1462	\$0.45/FT
3/16" (5 mm)	White/Green	1,300	#1457	\$0.45/FT
3/16" (5 mm)	Red	1,300	#1468	\$0.45/FT
3/16" (5 mm)	Blue	1,300	#1470	\$0.45/FT
3/16" (5 mm)	Green	1,300	#1469	\$0.45/FT
1/4" (6 mm)	White	2,500	#812	\$0.60/FT
1/4" (6 mm)	White/Red	2,500	#1453	\$0.65/FT
1/4" (6 mm)	White/Blue	2,500	#1463	\$0.65/FT
1/4" (6 mm)	White/Green	2,500	#1458	\$0.65/FT
1/4" (6 mm)	Red	2,500	#1472	\$0.70/FT
1/4" (6 mm)	Blue	2,500	#1474	\$0.70/FT
1/4" (6 mm)	Green	2,500	#1473	\$0.70/FT
5/16" (8 mm)	White	4,500	#815	\$0.80/FT
5/16" (8 mm)	White/Red	4,500	#1454	\$0.85/FT
5/16" (8 mm)	White/Blue	4,500	#1464	\$0.85/FT
5/16" (8 mm)	White/Green	4,500	#1459	\$0.85/FT
5/16" (8 mm)	Red	4,500	#1476	\$0.90/FT
5/16" (8 mm)	Blue	4,500	#1478	\$0.90/FT
3/8" (10 mm)	White	5,000	#833	\$1.00/FT
3/8" (10 mm)	White/Red	5,000	#1455	\$1.05/FT
3/8" (10 mm)	White/Blue	5,000	#1465	\$1.05/FT
3/8" (10 mm)	White/Green	5,000	#1460	\$1.05/FT
3/8" (10 mm)	Red	5,000	#1480	\$1.15/FT
3/8" (10 mm)	Blue	5,000	#1482	\$1.15/FT
3/8" (10 mm)	Green	5,000	#1481	\$1.15/FT
7/16" (11mm)	White	7,000	#120072	\$1.30/FT
7/16" (11mm)	White/Red	7,000	#120073	\$1.35/FT
7/16" (11mm)	Red	7,000	#120074	\$1.50/FT
1/2" (12 mm)	White	9,200	#1451	\$1.60/FT
1/2" (12 mm)	White/Red	9,200	#1456	\$1.70/FT
1/2" (12 mm)	Red	9,200	#1484	\$1.85/FT

## SALSA LINE™



STEEL GRAY (SG) SALSA RED (SR) GREEN (GN)

Ultra strong, ultra soft sheet line for larger one designs and keel boats. Made from Dyneema® SK75 fiber and blended with spun polyester. Easy to grip, easy to splice, and a proven kink-free mainsheet on the race course for boats that require a higher tensile strength such as J24s, Sonars, and Finns. Perfect for mainsheets, genoa sheets, traveler lines, and larger performance boats. Specify color when placing order.

DIAMETER	WEIGHT (LB/100/FT)	TENSILE (LB)	PART #	PRICE
1/4" (6 mm)	1.7	2,850	#103126	\$1.25/FT
5/16" (8 mm)	3.0	4,000	#103127	\$1.55/FT
3/8" (10 mm)	3.5	5,000	#103128	\$2.05/FT

## PREMIUM 3-STRAND NYLON



Long-wearing, flexible rope with superior strength and abrasion resistance to all other 3-strand nylon lines. High tenacity nylon with Marine Tech coating increases wet strength and improves fiber-to-fiber abrasion resistance. Easy to handle. Use for dock lines, anchor lines, and mooring lines.

DIAMETER	COLOR	TENSILE (LB)	PART #	PRICE
5/16" (8 mm)	White	2,950	#21202	\$0.40/FT
3/8" (10 mm)	White	4,100	#21203	\$0.50/FT
1/2" (12 mm)	White	7,500	#102369	\$0.85/FT
5/8" (16 mm)	White	11,650	#102370	\$1.35/FT
3/4" (18mm)	White	17,150	#102371	\$1.90/FT
7/8" (22 mm)	White	22,150	#102419	\$2.55/FT
1" (24mm)	White	27,700	#102420	\$3.35/FT

## NEW ENGLAND SPUN CLASSIC™



Relatively soft, easily worked spun polyester (Dacron) rope generally used along the luff and foot of mainsails and along the leading edge of "stretchy luffed" genoas and jibs. Softer loft lay than normal sheet line for easier working and splicing. Excellent longevity and stability. Many racers prefer Dacron polyester, although stretch is about half as much as nylon.

## SPYDERLINE™



BLACK (BK) RED (RD) PURPLE (PR)



MANGO (MG) LIME (LM)

Performance blend, lightweight dinghy control line with very high strength and low stretch. Flexible yet firm enough to be fed through small leads, micro blocks, and purchase systems. 100% polyester twill pattern cover with 100% Dyneema SK75 fiber core. Sizes over 1.8 mm have braided cores allowing for splicing and additional performance modifications. Use for dinghy and small one design cunninghams, vang systems, outhauls, halyards, traveler lines, trapeze lines, topping lifts, and twings. Specify color when placing order.

DIAMETER	WEIGHT (LB/100/FT)	TENSILE (LB)	PART #	PRICE
1/16" (1.8 mm)	0.2	350	#103129	\$0.30/FT
1/8" (2.8 mm)	0.4	1,250	#103130	\$0.60/FT
5/32" (3.8 mm)	0.8	1,860	#103131	\$0.90/FT
3/16" (4.8 mm)	1.3	3,000	#103132	\$1.25/FT

## NEW ENGLAND CLASSIC™



Traditional look and feel from this Dacron 3-strand rope, a replacement for woven wire rope. Very little stretch so sails can be hoisted tight without fear of overstressing, especially important at night or in a storm. Stretches a bit more than wire but will not corrode, fatigue, or snag. Great for halyards and cruising headsail luff reinforcement (storm jibs & drifters).

DIAMETER	COLOR	TENSILE (LB)	PART #	PRICE
3/16" (5 mm)	White	1,090	#21301	\$0.25/FT
1/4" (6 mm)	White	2,150	#21302	\$0.35/FT
5/16" (8 mm)	White	2,650	#21303	\$0.50/FT

DIAMETER	COLOR	TENSILE (LB)	PART #	PRICE
1/4" (6 mm)	White	1,240	#21204	\$0.35/FT
5/16" (8 mm)	White	2,200	#21205	\$0.50/FT
3/8" (10 mm)	White	2,800	#102368	\$0.65/FT

## T-900™



BLUE RED

Braided Technora (the strongest aramid fiber) and Dyneema creates a very low-stretch, highly abrasion and flexing fatigue resistant rope. Lightweight, firm line (softens over time) that holds well in clutches and does not hockle or develop meat hooks as wire does. Improves overall performance with easy handling, weight savings aloft, and extremely low stretch. Highly recommended for halyard replacements.

DIAMETER	COLOR	TENSILE (LB)	PART #	PRICE
1/4" (6 mm)	Red	4,700	#1433	\$1.55/FT
1/4" (6 mm)	Blue	4,700	#1434	\$1.55/FT
5/16" (8 mm)	Red	6,800	#1435	\$2.20/FT
5/16" (8 mm)	Blue	6,800	#1436	\$2.20/FT
3/8" (10 mm)	Red	11,000	#1437	\$3.15/FT
3/8" (10 mm)	Blue	11,000	#1438	\$3.15/FT
7/16" (11 mm)	Red	14,300	#120117	\$3.70/FT
1/2" (12 mm)	Blue	15,700	#120118	\$4.55/FT

## VPC™ HYBRID PERFORMANCE



WHITE RED GREEN BLUE

A high strength, low stretch alternative to a high tech line. VPC uses Hybrid Performance technology and features a blended Vectran® and polyolefin core with a durable polyester cover. This line fills the gap between performance polyester lines and ultra high performing lines. Use for mainsheets, halyards or jib sheets.

DIAMETER	COLOR	TENSILE (LB)	PART #	PRICE
1/4" (6mm)	White	3,200	#120083	\$0.90/FT
1/4" (6mm)	Red	3,200	#120084	\$0.90/FT
1/4" (6mm)	Green	3,200	#120085	\$0.90/FT
1/4" (6mm)	Blue	3,200	#120086	\$0.90/FT
5/16" (8mm)	White	5,500	#120087	\$1.30/FT
5/16" (8mm)	Red	5,500	#120088	\$1.30/FT
5/16" (8mm)	Green	5,500	#120089	\$1.30/FT
5/16" (8mm)	Blue	5,500	#120090	\$1.30/FT
3/8" (10mm)	White	6,500	#120091	\$1.70/FT
3/8" (10mm)	Red	6,500	#120092	\$1.70/FT
3/8" (10mm)	Green	6,500	#120093	\$1.70/FT
3/8" (10mm)	Blue	6,500	#120094	\$1.70/FT
7/16" (11mm)	White	8,500	#120095	\$2.20/FT
7/16" (11mm)	Red	8,500	#120096	\$2.20/FT
7/16" (11mm)	Green	8,500	#120098	\$2.20/FT
7/16" (11mm)	Blue	8,500	#120099	\$2.20/FT

## DOUBLE BRAID™ NYLON



WHITE/GOLD WHITE

Predictable strength, flexibility, and controlled elongation which helps balance the strain and stress on dock and anchor lines. Dimensionally stable and does not hockle. Use for drogue, dock, and mooring lines. Conforms to Mil-R-24050 B & C.

DIAMETER	COLOR	TENSILE (LB)	PART #	PRICE
3/8" (10mm)	White/Gold	4,800	#120081	\$0.85/FT
1/2" (12mm)	White/Gold	8,500	#120082	\$1.35/FT
5/8" (16 mm)	White/Gold	13,100	#1489	\$2.00/FT
3/4" (18 mm)	White/Gold	20,500	#688	\$2.70/FT
1" (25 mm)	White	32,750	#690	\$4.20/FT

## FLIGHT LINE DOUBLE BRAID



RED GREEN BLUE YELLOW

Strong, lightweight, flexible, low-stretch line perfect for tapering and great for smaller boats. Flight Line features a non-absorbent XLF cover and a 100% braided Dyneema® core. It's soft on the hands and gets softer with use! Use for light air spinnaker sheets, mainsheets, control lines and topping lifts.

DIAMETER	COLOR	TENSILE (LB)	PART #	PRICE
1/4" (6mm)	Red	2,500	#120100	\$1.20/FT
1/4" (6mm)	Green	2,500	#120101	\$1.20/FT
1/4" (6mm)	Blue	2,500	#120102	\$1.20/FT
1/4" (6mm)	Yellow	2,500	#120103	\$1.20/FT
5/16" (8mm)	Red	4,000	#120104	\$1.65/FT
5/16" (8mm)	Green	4,000	#120105	\$1.65/FT
5/16" (8mm)	Blue	4,000	#120106	\$1.65/FT
5/16" (8mm)	Yellow	4,000	#120107	\$1.65/FT
3/8" (9.5mm)	Red	4,700	#120108	\$2.25/FT
3/8" (9.5mm)	Green	4,700	#120109	\$2.25/FT
3/8" (9.5mm)	Blue	4,700	#120110	\$2.25/FT
3/8" (9.5mm)	Yellow	4,700	#120111	\$2.25/FT

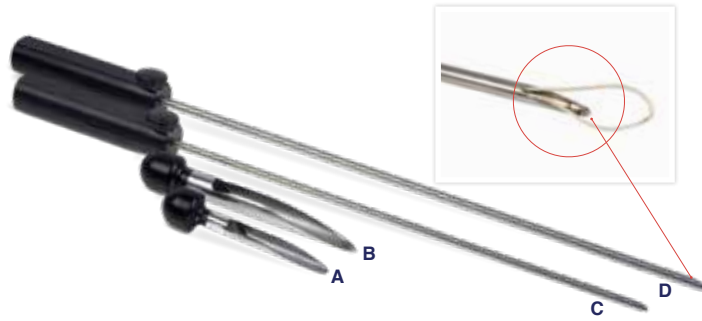

## ROPE SPLICING TOOLS

### POINT HUDSON PHID

Get smooth, fair splices without hockles or sliced yarn. Makes smaller holes than ordinary phids. Easy entrance even into hard-laid rope. Leave in rope to tuck strand with no yanking or dragging. Smooth edges prevent rope damage. Comfortable ball handle. Use with Mega-Braid and 3-Strand Rope. Includes instructions.

**A** SM (5/16"–5/8" rope) **#98746 \$49.95 EA**

**B** LG (3/4"–1-1/8" rope) **#28735 \$57.95 EA**

### BRION TOSS SPLICING WAND

Recommended by "Practical Sailor"

Splicing made easy! Slide into rope, grab the end to tuck, and pull out. Specially-shaped tip prevents snagging. Handle holds tube in place while working. Clamp in vise for two-handed rope work. No taping, untaping, or phid lengths to decipher. Requires very little physical effort. Includes instructions for double-braid eye splice.

**C** SM (3/16"–3/8" rope) **#59634 \$96.95 EA**

**D** MED (5/16"–1/2" rope) **#68634 \$96.95 EA**

LG (3/8"–3/4" rope) **#57634 \$114.95 EA**

### MICRO MARINE RATCHET WITH 1/8" ROPE 2 SS HOOKS

Lightweight and durable marine ratchet that allows you to quickly and easily secure your boat cover. Fits all 1/8" rope. Stainless steel components. Includes 1/8" Polyester Single Braid Cord. About 74" long. Working Load: 50 lb.

**E** **#105134 \$8.95 EA**



### LEECH LINE

Braided Dacron is used for lacing canvas panels and to secure lifeline netting. It is also used for flag halyards and in leech and foot hems on sails to control fluttering. More stretch and UV resistant than nylon.

5/32" White **#21210** 1-1,199 **\$0.25/FT** 1,200+ **\$0.20/FT**

1/8" White **#21209** 1-2,099 **\$0.15/FT** 2,100+ **\$0.12/FT**

1/8" Black **#212114** 1-2,099 **\$0.15/FT** 2,100+ **\$0.12/FT**

5/64" White **#21207** 1-999 **\$0.15/FT** 1,000+ **\$0.12/FT**

1/16" White **#21206** 1-999 **\$0.10/FT** 1,000+ **\$0.08/FT**



### TWISTED MANILA LINE

Easy-to-handle, general purpose 3-strand line with good resistance to internal and external wear. Low stretch and good knot holding ability. Manila has the greatest strength and abrasion resistance among natural fiber lines. Work load: 54 lb. limit. 1/4" (6 mm) diameter.

**#562911 \$0.20/FT**

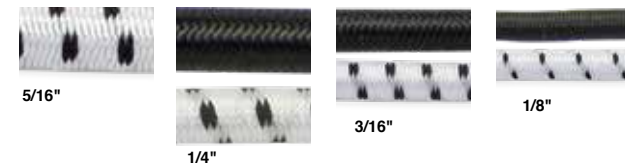

### SHOCK CORD

Great for tie downs, jiffy reefing ties, spinnaker turtle bag closures, and even luff reinforcement in smaller sails (where stretch allows for very effective draft control). Nylon cover increases durability.

DIAMETER	COLOR	PART #	1-499	500+
5/16"	White	#29300	\$0.45/FT	\$0.36/FT
1/4"	Black	#104326	\$0.35/FT	\$0.28/FT
3/16"	Black	#104328	\$0.20/FT	\$0.16/FT
3/16"	White	#29303	\$0.30/FT	\$0.24/FT
1/8"	Black	#104327	\$0.15/FT	\$0.12/FT

DIAMETER	COLOR	PART #	1-99	100+
1/4"	White	#29304	\$0.35/FT	\$0.30/FT
1/8"	White	#29302	\$0.20/FT	\$0.17/FT



**1/8" VINYL-COATED**

**3/32"**

### WIRE ROPE

Stainless steel 7 x 7 construction wire rope is great for lifelines or as a traditional low stretch luff reinforcement for headsail. Choose the vinyl-coated wire to prevent Dacron discoloration from corrosion or to secure as luff reinforcement with a sticking stitch (desirable with larger sails). Use the 1 x 19 wire rope for standing rigging or headsail furling wire on small boats. Other lifeline wire available on p.193.

### BY THE FOOT

DIAMETER	COATING	STRAND	PART #	PRICE
3/32"	-	7 x 7	#21305	\$0.40/FT
3/32"	-	1 x 19	#104302	\$0.40/FT
1/8" (1/4" coated)	Vinyl	7 x 7	#21306	\$0.95/FT
1/8"	-	7 x 7	#105433	\$0.60/FT

### NEW PRECUT COILS

DIAMETER	STRAND	PART #	LENGTH	PRICE
3/32"	1 x 19	#121107	25 FEET	\$13.65 EA
3/32"	1 x 19	#121108	50 FEET	\$26.60 EA
3/32"	7 x 7	#121106	25 FEET	\$12.75 EA
3/32"	7 x 7	#121109	50 FEET	\$24.70 EA
1/8"	7 x 7	#121038	100 FEET	\$62.40 EA
1/8"	7 x 7	#121039	200 FEET	\$114.00 EA



### AWNING ROPE

Vinyl Extruded Awning Rope

One-piece vinyl awning rope. Tail can be sewn to fabric. Excellent seal but hard to slide through awning track. Overall width: 1". Cord diameter: 3/8".

**A** White **#1371** 1-99 **\$0.75/FT** 100+ **\$0.68/FT**

**B** Black **#120148** 1-99 **\$0.75/FT** 100+ **\$0.68/FT**

### KEDER AWNING ROPE

Strong and designed to slide more smoothly in awning track. Heavy-duty coated polyester fabric welded to a hard, round PVC core material. Least likely to pull free from the track. Sew to fabric edge and slide into track. Overall width: 1-1/8". Cord diameter: 5/16".

**C** Black **#103299 \$1.45/FT**

**D** White **#102549 \$1.20/FT**

### E SPLINE CORDING

Designed for awnings and sling chairs. Hollow, low density polyethylene tubing will not rot, absorb water, shrink or unravel. Make a pocket in the fabric, insert cording, and slide into the extrusion. Outside diameter: 1/4".

**#103839** 1-999 **\$0.40/FT** 1,000+ **\$0.28/FT**

Attach awning rope to the edge of fabric and slide into awning track. Creates a strong, nearly waterproof attachment.

**F** Anodized aluminum track p.184

**G** Keder rail strip p.184





## CUSTOM SAIL KITS

*Get exactly what you want, when you need it*

Building your own sail kit is a rewarding and satisfying experience. There is a real sense of accomplishment that comes with hoisting a sail you built yourself. Plus, the skills acquired along the way will make you a more self-reliant sailor. Sailrite's customizable sail kits make the process easy and affordable.

### THE BENEFITS OF A SAILRITE SAIL KIT:

- **ONLY THE HIGHEST QUALITY MATERIALS**  
Get the same materials used by professional sailmakers at a fraction of the price!
- **CUSTOM DESIGNS FOR MAXIMIZED PERFORMANCE**  
Draft, twist, and entry and exit curves are all carefully calculated, controlled, and positioned on each sail.
- **STATE-OF-THE-ART TECHNOLOGY**  
Each sail kit is plotted using cutting edge programs and equipment. Panels are computer cut with pre-drawn seaming lines.
- **GUARANTEED QUOTES**  
Each sail kit includes all the materials you'll need to complete your sail.
- **EASY TO FOLLOW INSTRUCTIONS**  
Each kit comes complete with custom, illustrated instructions.
- **PERSONAL ASSISTANCE**  
Sailrite's expert staff is available every working day to answer questions and to help guide you through the ordering and construction process.

### READY-TO-ORDER POPULAR SAIL KITS

Ordering Your Sail Kit Is Just a Click Away

We now offer easy-to-order kits for hundreds of our most popular standard sails. These include sails for common home-built boat models as well as smaller high-production boats. Kits are computer cut in the Sailrite loft with hem and seam lines marked right on the cloth and come complete with all the materials you'll need.

Shop all popular sail kits at [Sailrite.com/Popular-Sail-Kits](https://www.sailrite.com/Popular-Sail-Kits).



▲ Jeff Frank, Sail Designer since 1991

### GET A QUOTE!

1. Go to:  
[Sailrite.com/sailmaking](https://www.sailrite.com/sailmaking)

2. Select Dinghy/One Design or Cruiser/Racer.

#### Dinghy/One Design:

Generally smaller boats. Dinghies typically have only one sail and One Design boats have class-defined specifications for each sail.

**Cruiser/Racer:** Generally larger boats with multiple combinations of sail types and sizes determined by boat rig dimensions.

3. Complete the appropriate form. Include your sail/boat specifications and contact information.

We'll send a quote after we receive your form! We may need to contact you to get a few additional details to complete your quote. Review your quote and if you like what you see, grab your estimate number and payment information and call, email, or chat with us! It's that simple!

# Learn the Art of Sailmaking

## SAILMAKER'S LIBRARY (5 BOOK SET)

by Jim Grant, 407 pgs. Soft cover.

Learn the essentials of sail construction with this comprehensive set of how-to manuals that feature step-by-step descriptions and illustrations of sail construction techniques. Gain a greater understanding of the importance of proper sail shape for given boats, conditions, and helmsman capabilities, and learn keys to broadseaming, luff round, foot and leech roaches, boltroping, and headboard and batten installation.

**BONUS!** Get 'Mathematics for Sailmakers' and 'Mylar Coated Sailcloth' inserts when you order the complete set!

**#36101A \$51.10 SET**

## MAINSAILS: DESIGN & CONSTRUCTION 86 pgs.

Bermuda mains (triangular sails often called mainsails or mizzen sails). Extensive appendices on lateen, gaff, and sprit rigged sails.

**#36201 \$11.95 EA**

## JIBSAILS: DESIGN & CONSTRUCTION 90 pgs.

Working jibs, traditional staysails, genoas, topsails, mule jibs, drifters and reachers - all triangular sails hoisted on a forestay with mainsail aft.

**#36301 \$6.95 EA**

## SPINNAKERS: DESIGN & CONSTRUCTION 107 pgs.

Running, reaching, storm, and cruising spinnakers, plus spankers and bloopers. Includes instructions for radial, tri-radial, and star cuts.

**#36203 \$8.95 EA**

## STORMSAILS: DESIGN & CONSTRUCTION 50 pgs.

Storm foresails, trysails, and Swedish mainsails. Focuses on sturdy construction, one of the most important characteristics of these sails.

**#36202 \$11.95 EA**

## STAYSAILS: DESIGN & CONSTRUCTION 62 pgs.

Genoa staysails, 150% staysails, spinnaker staysails, tallboys, and cheaters - special purpose sails used on modern sloops to increase performance in light to medium air while reaching or running.

**#36303 \$10.95 EA**



## SAIL COVER INSTRUCTION BOOKLET

A comprehensive instruction manual for 3 of the most common sail covers: Throated Sail Cover, Rectangular Sail Cover, & Sail Pack. Features step-by-step patterning, sewing, and installation instructions with drawings and helpful techniques. Included with all Sailrite Sail Cover Kits. 60 pgs.

**#104786 \$5.95 EA**



# SPINNAKER SOCK KITS

Popular for both cruising and racing sailors! Protect your valuable sail investment and make spinnaker setting and dousing easier. Sailrite's tapered spinnaker sock design is extremely effective and easy to make.

## FEATURES:

- White polyester mesh fabric allows sail to dry when stored.
- Reinforced wear points.
- Colorful exterior pocket visually indicates twists in sock.
- Stainless steel hoop holds bottom of sock open when raising or lowering.
- Control line attaches to rope harness which attaches to hoop.
- Harken block at top of sock allows line to run smoothly.
- Wire pennant with head swivel keeps sock from interfering with sail shape.
- Kink-free 3/8" control line.
- Exterior nylon pocket holds single continuous control line to eliminate fouling and keep the line out of contact with the sail.

**ORDERING:** For asymmetrical sails (cruising spinnakers), select sock size based on sail's leech stay length. For symmetrical sails (regular spinnakers), select a sock size that is 4-6 feet shorter than the sail's leech stay length. White sock with colored exterior pocket (color varies and may not be specified).

**KITS INCLUDE:** Ripstop, mesh, Dacron Sailcloth, basting tape, Regatta Light line, leech line, webbing, Dacron tape, Velcro, hoop, thread, twine, needle, Harken block, stop, and instructions.

*Sewing machine, scissors, and hotknife (soldering iron) are required for construction.*



LENGTH		LENGTH	
18'-21'	#100117 \$227.00 KIT	39'-42'	#100124 \$328.40 KIT
21'-24'	#100118 \$239.20 KIT	42'-45'	#100125 \$345.55 KIT
24'-27'	#100119 \$251.40 KIT	45'-48'	#100126 \$358.75 KIT
27'-30'	#100120 \$263.60 KIT	48'-51'	#100127 \$371.95 KIT
30'-33'	#100121 \$275.80 KIT	51'-54'	#100128 \$385.15 KIT
33'-36'	#100122 \$289.10 KIT	54'-57'	#100129 \$398.35 KIT
36'-39'	#100123 \$300.20 KIT	57'-60'	#100130 \$411.55 KIT



1

## PREPARE YOUR SAILS FOR FURLING AND REEFING

Modern furling/reefing units are very efficient and convenient additions for sail use. They are easy to install but most require continuous support tape along the leading edge of sails that can slide into a groove in the furler. All wire, rope, snaps, and grommets must be removed and cut away to convert this sail edge to continuous support tape. This is also a great time to shorten the luff as the drum and swivel of the furling unit reduces usable maximum sail hoist.



2

## PROTECT THEM FROM THE SUN!

Sails that are left furled on the forestay should have protection from sun and weather. One solution is to completely cover the furled sail by pulling a sock or sleeve up over the furled sail with a spare halyard. This is the best choice for boats under 30' and boats with older headsails that will soon be replaced and hoisted on the same furler. A sock is lightweight and can be used for multiple sails but does require a longer installation time.

Another solution is to sew a strip of sacrificial UV resistant fabric along the foot and leech edges of a sail. When the sail is furled, only the sacrificial fabric will be exposed to sunlight thereby protecting the actual sailcloth. This is common on cruising boats where ease of use and maximum (automatic) protection is the primary concern.

↳ Shown with sacrificial sun cover.



### LUFF TAPE CONVERSION KITS

Prepare your sail for a reefing/furling unit with continuous support tape installation and luff reduction. Measure the sail's luff (leading edge) to order the appropriate kit. Call to request a different tape size (#6 is standard).

**KITS INCLUDE:** Continuous support tape (#6), white thread, basting tape, blue draft tape, tubular webbing, 1-1/4" stainless steel rings, pre-waxed twine, hand needle, and instructions.



### SLEEVE (SOCK) FURLING COVER KITS

Make your own furling sleeve! Features Sur Last fabric and a series of finished zippers that close the sleeve as it is raised up over the sail. Includes up to three finished zippers to be installed and used in sequence for total length.

**ORDERING:** Sleeve size should be at least the length of the sail's luff (forward) edge.

**KITS INCLUDE:** Sur Last cover cloth (select color on p.29 or use pull down menu if ordering online), thread, white marine zipper(s), webbing, basting tape, and complete instructions.



LUFF	PART #	PRICE
15'-21'	#100321	\$74.75 KIT
22'-28'	#100323	\$90.50 KIT
29'-35'	#100326	\$106.25 KIT
36'-42'	#100328	\$122.00 KIT
43'-49'	#100331	\$138.25 KIT
50'-56'	#100333	\$154.00 KIT
57'-63'	#100334	\$169.75 KIT

LUFF	PART #	PRICE
15'-21'	#100240	\$100.30 KIT
22'-28'	#100241	\$124.05 KIT
29'-35'	#100242	\$146.85 KIT
36'-42'	#100243	\$166.25 KIT
43'-49'	#100244	\$208.60 KIT
50'-56'	#100245	\$231.40 KIT
57'-63'	#100246	\$254.15 KIT

### SACRIFICIAL SAIL SUN COVER KITS

Protect with the best! Choose Sunbrella, the most popular choice for unparalleled durability in sunlight, or 4 oz. Insignia UV Dacron, a lightweight fabric great for boats under 30 feet, to protect your sails. The width of the sacrificial strip should span the exposed edge of the sail when rolled onto the forestay (add 6" to allow for sloppy furling). Measure the exposed edging of your furled sail. If you can't measure the sail furled, use the chart below to determine the width. Note: the chart estimates are rounded "wide" since the only negative is slightly more weight.

**ORDERING:** Select kit size by adding the sail's leech and foot edge dimensions.

BOAT LOA	20'	25'	35'	45'	50'
FOOT WIDTH	10"	14"	14"	18"	20"
LEECH WIDTH	14"	18"	20"	24"	26"

🔥 Flammable (p.256)

### SUNBRELLA SUN COVER KITS

MAX LENGTH (Leech + Foot)	MAX. PANEL WIDTH	AVERAGE. BOAT LOA	PART #	PRICE
40'	12"	20'	#102880	\$114.60 KIT
50'	16"	25'	#102881	\$172.40 KIT
60'	18"	35'	#102882	\$206.30 KIT
70'	20"	40'	#102883	\$272.15 KIT
80'	20"	45'	#102884	\$289.10 KIT
90'	24"	50'	#102885	\$373.85 KIT

#### KITS INCLUDE:

Sunbrella 46" Marine Grade fabric (select color on p.14-18 or use pull down menu if ordering online), outdoor thread, basting tape, spray adhesive, and installation instructions.

### UV INSIGNIA SUN COVER KITS

MAX. LENGTH (Leech + Foot)	MAX. PANEL WIDTH	AVERAGE BOAT LOA	PART #	PRICE
30'	10"	20'	#102777	\$95.40 KIT
40'	14"	25'	#102778	\$153.70 KIT
50'	18"	30'	#102779	\$217.05 KIT

#### KITS INCLUDE:

Adhesive-backed white UV insignia, outdoor thread, basting tape, UV Dacron edge tape, and installation instructions. (Install UV Insignia on new or nearly new sails. Wrinkles make proper installation difficult.)

## THROATED SAIL COVERS

Cover and protect your mainsail when flaked. Fastens under the boom using Common Sense fasteners with snap buttons to provide a polished appearance and reduce chafe. Secures around the mast with a marine zipper. Features pre-patterned Sunbrella fabric and requires only a sewing machine and scissors to complete.

Approximate construction time: 4 hours.

**FREE** video online (#X-HT-300180) with complete project details.



## SAIL PACK KITS

A popular adaptation of a standard mainsail cover that makes the deployment and recovery of a mainsail quick and easy. Just drop the sail and zip it shut! Remains flat against the sail while sailing or can be removed.

Integrates with a lazy jack system (not included) to support top and guide sail into place. Features PVC pipe sleeve design, top zipper closure, and removable forward mast boot.

Works best on mainsails with slugs or slides along luff but also accommodates a boltrope. Full length battens encourage proper flaking, but this kit will work with sails that have standard battens.

Approximate construction time: 5 hours.

**FREE** video online (#X-HT-200598) with complete project details.



### KITS INCLUDE:

Sunbrella fabric (select color\* on p.14-18 or use pull down menu if ordering online), Common Sense fasteners, snap buttons, snap fastener tool, white marine zipper, white UVR thread, Dacron leech line, leather (for chafe protection and reinforcement), basting tape, and Sail Cover Instruction Booklet.

### LAZY JACK SLITS:

Throated Sail Cover Kit Instructions include directions for creating lazy jack slits. If required, order an extra 6 feet of 1" acrylic binding tape (p.141) and 3 Common Sense Fasteners (#777200 p.177) for EACH slit.



Zipper secures cover around mast.



Fastens under boom with Common Sense fasteners.



Boot top



### KITS INCLUDE:

Sunbrella fabric (select 60" color on p.14-18 or use pull down menu if ordering online), Common Sense fasteners with buttons, snap fastener installation tool, basting tape, thread, Dacron tape, white marine zippers, stainless steel zipper stops, d-rings, webbing, Dacron chafe protection material, and Sail Cover Instruction Booklet.

### ALSO REQUIRED (SOLD SEPARATELY):

Lazy Jack system (p.194), schedule 40 PVC 3/4" pipe, sewing machine, scissors, hot knife (p.136-137) or wood burning tool, and razor blade.

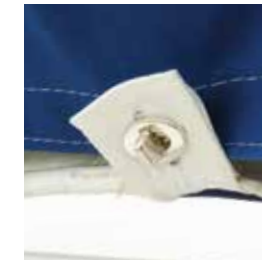

Secures under sail's foot edge with webbing straps and Common Sense fasteners.



Sleeve opening for PVC pipe to keep cover open when lowering sail.

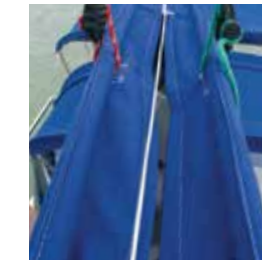

Zip closure along top of pack.

### ORDERING:

Determine the length of the boom measuring from the mast to the boom end (not including mast width) and choose the kit with length equal to or greater than the length of your boom.

MAX. BOOM LENGTH	MAX. SAIL STACK HEIGHT AT MAST	MAX. HEIGHT AT CLEW	PART #	PRICE
10'	31"	6"	#200295	\$209.95 KIT
13'	45"	12"	#200296	\$266.15 KIT
16'	45**	45"	#200297	\$329.95 KIT
19'	45**	45"	#200298	\$384.05 KIT

\*For sail stacks higher than 45 inches, use leftover fabric scraps or order additional fabric to make a "wedge" panel to cover the additional height. Order roughly one extra yard of fabric per 5 inches of additional height. Written instructions are included.

### ORDERING:

Measure the longest reach of the mainsail along the boom (not including the mast width) and choose the kit with length equal to or greater than the length of your boom.

KITS		
10' Boom Kit	#1151	\$150.55 KIT
13' Boom Kit	#1152	\$199.15 KIT
16' Boom Kit	#1153	\$239.90 KIT
19' Boom Kit	#1154	\$260.35 KIT

\* Choose from the 46" width Sunbrella Marine Grade fabrics for kit #1151. Choose from the 60" width Sunbrella Marine Grade fabrics for kits #1152, #1153 & #1154.

## BIMINI KITS

Build your own custom bimini to offer you protection from the sun and shelter from rain and spray. Sailrite kits are available in two parts; bimini frame kits and bimini skin kits. To order everything you need to build a bimini from start to finish, choose the appropriate frame kit and then add a skin kit, in the fabric color of your choice, to match.

Our Bimini Frame Kits are made with either marine grade 304 stainless steel or anodized aluminum tubing and contain 316 stainless steel fittings. Bimini Skin Kits come with Sunbrella Marine Grade fabrics in your choice of standard or premium colors. Other marine grade fabrics can be substituted in your kit upon request.

Add window material and/or extra zippers to your kit to make curtains, bridge panel attachments, backstay slits or a window for improved visibility.

Watch our streaming video instructions to learn how to build your frame and kit step-by-step at Sailrite.com.

**Main Image:** Shown with custom webbing extension and backstay slit. To modify with a backstay slit, add a #10 finished zipper, 1 extra pull slider and 3" vinyl tape. Instructions included.

The standard attachment method for webbing straps is a strap eye riveted to the bimini frame. (Included in bimini frame kits) ▶



## BIMINI BOW ASSEMBLY

Assembly is easy! The anodized aluminum or stainless steel tubing in Sailrite Bimini Kits are bent with our custom jig and cut just beyond the bow to keep shipping costs down and provide for on-site customization. Cut the crowned center tubing to make width adjustments, or cut the frame legs to make height adjustments. Insert splines into each end of the center tubing and rivet through the center tube and spline for a permanent joint. The result is an affordable, high-quality bow that is stronger and more affordable than custom welded bows or the uncut original.



2-Bow Frame



3-Bow Frame



4-Bow Frame



#121315



#121334

## BIMINI FRAME KITS

Everything you need to build a bimini frame! Includes all tubing (marine grade 304 stainless steel or anodized aluminum), and stainless steel fittings such as jaw slides, eye ends, and Universal Deck Hinges (all machine screw connections) as well as strap eyes and deck mounting screws to build a complete frame. Stainless steel rivets are also included for assembling the frame as well as filament strapping tape to aid in supporting the frame prior to installation. Tubing bows come pre-bent in three sections (2 curved, 1 crowned). Kits do not contain webbing support straps. Refer to chart for measurements (p.232). A drill, hacksaw, rivet tool and basic hand tools are required for installation.

2-Bow 7/8" Aluminum #121318 \$265.55 KIT

2-Bow 7/8" Stainless #121319 \$345.55 KIT

2-Bow 1" Stainless #121321 \$394.55 KIT

3-Bow 7/8" Aluminum #121313 \$361.70 KIT

3-Bow 7/8" Stainless #121314 \$481.70 KIT

3-Bow 1" Stainless #121315 \$555.70 KIT

4-Bow 7/8" Stainless #121316 \$667.85 KIT

4-Bow 1" Stainless #121317 \$765.85 KIT

## BIMINI SKIN KITS

Make your own fabric bimini top with our Bimini Skin Kits. These kits can be used in conjunction with our bimini frame kits or to add a new top to an existing bimini frame. Select according to the maximum width and spread (see frame sizing chart). Kits include: Sunbrella Marine Grade Fabric (46" wide in 2-bow kits, 60" in 3-bow and larger), binding, white thread, Sunbrella webbing for support straps, white marine zippers, patterning material, buckles, basting tape, snap hooks, filament strapping tape and written instructions. Does not include frame, frame fittings or strap eyes. Sewing machine, scissors and basic hand tools are required for construction.

Select your Sunbrella color on p.14-18 or use the pull down when ordering online. Premium colors are denoted with **P**.

2-Bow with Standard Sunbrella Color #121342 \$298.40 KIT

2-Bow with Premium Sunbrella Color #121341 \$314.90 KIT

3-Bow with Standard Sunbrella Color #121334 \$382.20 KIT

3-Bow with Premium Sunbrella Color #121333 \$403.20 KIT

4-Bow with Standard Sunbrella Color #121340 \$467.45 KIT

4-Bow with Premium Sunbrella Color #121339 \$495.20 KIT

## FRAME SIZING

Determine the desired width, height and spread (fore & aft) for your bimini. Use the chart below to select the proper frame kit size for your boat. Frames are designed to be cut down from their listed sizes. To cut the tubing, use a hacksaw with a blade with 24 teeth per inch. Adjustments to these measurements can also be made for your boat. Remember, as the height is increased above the nominal height, the maximum typical spread decreases.

For any bimini, but particularly 2-bow biminis, you can choose to install the frame on your deck or at your pushpit railing. Installation at the rail requires additional rail mount hardware (p. 88-89).

TYPE	MAX. WIDTH	LONGEST LEG LENGTH	NOMINAL HEIGHT AT TYPICAL SPREAD*	MAX. SPREAD (FORE & AFT)	MAX. BETWEEN BOWS	BOW ANGLE TO WATERLINE
2-Bow Bimini	106"	63"	60"	42"	42"	70°
3-Bow Bimini	106"	63"	44"	84"	42"	45°
4-Bow Bimini**	106"	71"	51"	98"	42"	45°

\*Before crown and frame fittings (add approximately 3")

\*\*A maximum spread of 126" can be achieved with this frame with a reduced height of 35" before fittings and crown



Learn how to make your own custom bimini online at Sailrite.com with our free step-by-step instructional videos. Search the part number of the kit you're interested in and scroll down to the bottom of the item page for the video instructions.



## New & Improved! WEBBING STRAP KIT

Adjust the tension on boat tops and covers with a single pull. Finished webbing strap can adjust between 2-6 ft. Kit results in straps, as shown in main image on page 232, that do not require strap eyes to be riveted to the frame.

**KITS INCLUDE:**

1" Sunbrella Webbing Natural, webbing slider, loop loc, snap hook, thread, and instructions.

#121359 \$22.30 KIT



## DODGER KITS

Build a dodger to protect you from the sun and offer shelter from rain and spray. Customize the perfect dodger for your boat at an affordable price when you do-it-yourself. Sailrite kits are available in two parts; a dodger frame kit and dodger skin kit. To order everything you need to build a dodger from start to finish, purchase the frame kit and then add a skin kit in the fabric color of your choice.

Dodger frames are made of 1" marine grade 304 stainless steel tubing and include 316 stainless steel fittings. Dodger Skin Kits come with Sunbrella Marine Grade fabric in your choice of standard or premium colors. Other marine grade fabrics can be added to kits upon request.

Skin kits come with our Make Your Own Dodger DVD that includes video and written PDF instructions to make construction easy. Visit [Sailrite.com](http://Sailrite.com) for more information.

Customize with optional support struts that run forward (sold separately, p.200) or optional grab rails (sold separately, p.200). ▶



▼ CUSTOMIZE WITH AN OPTIONAL FRONT ROLL-UP WINDOW.  
Additional materials required: 2 - #10 double pull locking finished zippers (3" longer than window height), 2 cloth-to-cloth snap fasteners (complete set), and 20 ft. 3/4" binding.



## DODGER FRAME KIT

Everything you need to build a dodger frame! Kit includes: 1" stainless steel tubing and stainless steel eye ends, jaw slides, Universal Deck Hinges (all machine screw connections), strap eyes and deck mounting screws. Filament strapping tape is included to aid in supporting the frame prior to installation. Tubing bows come pre-bent in three sections (2 curved, 1 crowned). Stainless steel rivets are included for building the frame. Does NOT include webbing support straps, DVD video or fabric. Refer to frame sizing chart for measurements (p.234)

2-Bow 1" Stainless **#121345 \$383.85 KIT**



## FRAME SIZING

Determine the desired width, height and spread (fore & aft) for your dodger. Compare with the chart below to be sure our frame will adequately fit your boat. The given sizes are maximum dimensions for a frame with a normal set, with primary bows set at roughly a 45-degree angle to the waterline and the secondary bow at less than 90-degrees from the primary. Orientation can be adjusted—for example, the height can be increased, but it will decrease the spread. Frame kits can be cut down from listed sizes in both height and width. To cut the tubing, use a hacksaw with a blade with 24 teeth per inch.

TYPE	MAX. WIDTH	LONGEST LEG LENGTH	NOMINAL HEIGHT AT MAX. SPREAD*	MAX. SPREAD** (FORE & AFT)	MAX. BETWEEN BOWS
2-Bow	84"	46"	33"	70"	40"

\*Before crown and frame fittings (add approximately 3")  
\*\*Includes front sloping panel.



## DODGER SKIN KITS

The fabric portion of a dodger, our skin kits are sized to fit our Dodger Frame Kit. Skin-only kits can also be used to refresh the fabric on an existing dodger frame. Kits fit a maximum frame width of 84" and a maximum spread of 40" with a length fore and aft of up to 70", including the front dodger panel.

Kits include: 46" Sunbrella fabric (in color of your choosing), 30 gauge O'Sea window material, binding, white thread, patterning material, Sunbrella webbing for support straps, white marine zippers, patterning material, buckles, basting tape, snap hooks, hook and loop, leather twine, hand needle, fasteners, filament strapping tape and a DVD with video and written PDF instructions. Does not include frame, frame fittings or strap eyes. A sewing machine, scissors and basic hand tools are required for construction.

Select your Sunbrella color on p.14-18 or use the pull down if ordering online. Premium colors are denoted with **P**.

2-Bow with Standard Sunbrella Fabric **#121343 \$506.50 KIT**  
2-Bow with Premium Sunbrella Fabric **#121346 \$525.75 KIT**

## DODGER BOW ASSEMBLY

Assembly is easy! The polished marine grade 304 stainless steel tubing in Sailrite's Dodger Frame Kits is bent with our custom jig and cut just beyond the bow to keep shipping costs down and provide for on-site customization. Cut the crowned center tubing to make width adjustments, or cut the frame legs to make height adjustments. Insert splines into each end of the center tubing and rivet through the center tube and spline for a permanent joint. The result is an affordable, high-quality bow that is stronger and more affordable than custom welded bows or the uncut original.



1-Bow Frame



2-Bow Frame

## 1-BOW FRAMES

Order a single bow to replace a worn-out bow on an existing bimini or dodger or to further customize your design. Single bows are pre-bent at Sailrite and come in three pieces (2 curved, 1 crowned). Bows include connection splines and stainless steel rivets. Max width: 106"

**TALL** (Longest leg length: 71")

1-Bow for 7/8" Stainless (No Fittings) **#106399 \$178.50 EA**

1-Bow for 1" Stainless (No Fittings) **#106400 \$199.50 EA**

**STANDARD** (Longest leg length: 63")

1-Bow 7/8" Alum. (No Fittings) **#100423 \$133.30 EA**

1-Bow 7/8" Stainless (No Fittings) **#100424 \$173.30 EA**

1-Bow 1" Stainless (No Fittings) **#100425 \$194.30 EA**

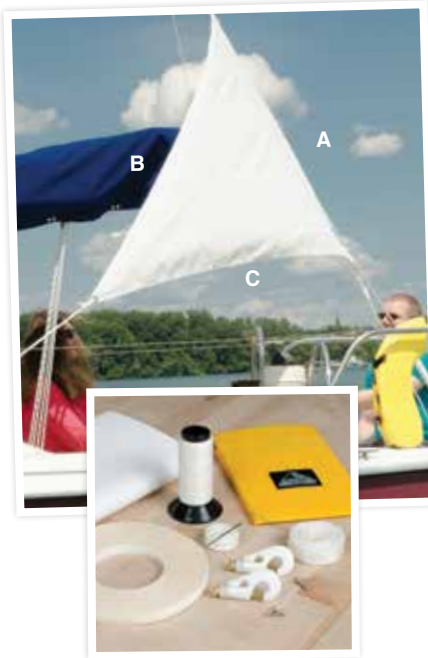

## ANCHOR RIDING SAILS

Keep your boat pointed in one direction instead of swinging side to side while anchored. Hank onto the backstay and sheet forward to one side (preferably to a toe rail). Also a great way to try your hand at sailmaking! Complete on any home sewing machine with no other special tools required. Features UV and chafe resistant white 11 oz. Top Gun material.

DIMENSIONS	SMALL	LARGE
LUFF (A)	4'10"	7'3"
LEECH (B)	6'3"	6'9"
FOOT (C)	6'0"	7'3"

### SMALL SAIL (12.5 SQ. FT.)

For boats up to 35 feet.

#### KITS INCLUDE:

1 precut Top Gun fabric panel, UVR thread, #2 Ronstan Snaps (for 5/16" wire), webbing, basting tape, hand needle, twine, instructions, and finished sail bag.

**KIT #90011A \$105.55 KIT**

### LARGE SAIL (20.25 SQ. FT.)

For boats up to 50 feet.

#### KITS INCLUDE:

2 precut Top Gun fabric panels, UVR thread, #3 Ronstan Snaps (for 7/16" wire), webbing, basting tape, hand needle, twine, instructions, and finished sail bag.

**KIT #90012A \$128.55 KIT**



## HATCH CANOPY KIT

Protect an open hatch from sun and rain while allowing air to flow down into the cabin. Provides excellent shade protection over the hatch. Features Sur Last fabric, a tough 100% solution-dyed polyester, for excellent weather and abrasion resistance with good breathability.

**MAXIMUM WIDTH: 56"**  
**MAXIMUM LENGTH: 67"**

Easily adjust the front edge of the canopy to either maximize air flow or block inclement weather. Attach with stabilizing lines around the forestay wire, furled sail, or bow pulpit in the front and stanchions or shrouds in the back. Use the adjustable webbing strap to attach around a furled sail. Roll-up to store.

#### KITS INCLUDE:

Sur Last fabric (select color on p.14-18 or use pull down menu if ordering online), thread, basting tape, webbing, double side release buckle, batten, aluminum tubing, nylon inside eye ends, spring ball, rope, leech line, and online streaming video instructions. Recommended (not included): Micro Marine Ratchet (p.222) for quick line tension adjustments.

**#103626 \$94.15 KIT**

#### MORE ON SAILRITE.COM

Learn how to make a hatch canopy and anchor riding sail online at [Sailrite.com](http://Sailrite.com) with our **FREE** instructional videos #X-HT-200482 and #X-HT-200115



## BINNACLE WHEEL COVER KITS

Protect your boat's compass and wheel! This easy and affordable canvas cover features breathable and UV resistant Sunbrella Marine fabric for a long-lasting, durable cover that will not promote condensation around your important instruments.

Also features a zippered opening for quick installation and removal and an elasticized bottom hem for secure positioning.

#### KITS INCLUDE:

Sunbrella fabric (select color\* on p.14-18 or use pull down menu if ordering online), patterning material, strapping tape, basting tape, white marine zipper and slider, shock cord, thread, and the Make Your Own Binnacle Cover DVD.

MAX. HEIGHT	MAX. WHEEL DIA.	PART #	PRICE
48"	28"	#103516	\$94.30 KIT
60"	40"	#103517	\$132.10 KIT
72"	54"	#103518	\$171.20 KIT

\* Choose from the 46" width Sunbrella Marine Grade fabrics for kits #103516 & #103517. Choose from the 60" width Sunbrella Marine Grade fabrics for kit #103518.



## FOREDECK BAGS

Protect your sails and free up room in the sail locker with headsail storage on the deck. Features Sunbrella fabric with Dacron sailcloth reinforcements at upper and lower openings. Front edge zipper closure offers complete weather protection and secure attachment to forestay wire. Attach halyard to aft end webbing loop to lift bag off the deck.

Approximate construction time: 2 hours.

#### KITS INCLUDE:

Pre-patterned Sunbrella 46" fabric (select color on p.14-18 or use pull downs when ordering online), Dacron tape, white marine zipper, thread, webbing, and instructions.

#### MAX. SAIL SIZE RECOMMENDATION (SQ. FT.)

BOAT LENGTH	DIMENSIONS	WORKING AIR	MEDIUM AIR	LIGHT AIR	PART #	PRICE
20'	22"H x 35"L x 13" Dia.	100	175	250	#111F2	\$58.80 KIT
30'	30"H x 45"L x 18" Dia.	200	275	350	#111F3	\$77.25 KIT
40'	38"H x 45"L x 23" Dia.	300	400	500	#111F4	\$78.80 KIT
50'	45"H x 45"L x 28" Dia.	400	500	600	#111F5	\$95.75 KIT
60'	54"H x 45"L x 33" Dia.	450	550	650	#111F6	\$113.45 KIT



## RECTANGULAR SAIL COVERS

Popularized by J Boats for sails that come completely out of the track at the mast (no mast slugs or slides). Easy to build and quick to install. Features long-lasting Sunbrella fabric that lays over the boom and secures with Common Sense fasteners. Hang down length can be reduced.

#### KITS INCLUDE:

Sunbrella 46" fabric (select color on p.14-18 or use pull down menu if ordering online), Common Sense fasteners, snap fastener installation tool, thread, binding tape and Sail Cover Instruction Booklet.



#### RECTANGULAR SAIL COVER KIT #50310 \$143.25 KIT

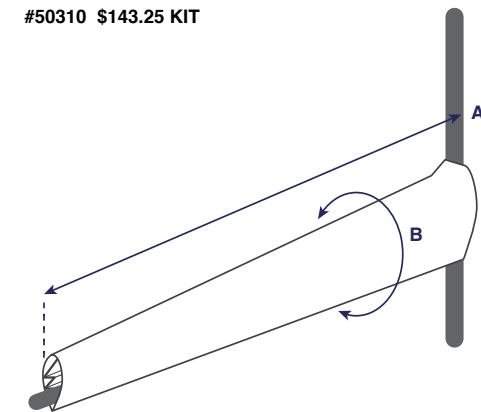

**Maximum length A:** 16 feet  
**Maximum circumference B:** 40 inches  
**A** Front of mast to aft edge of flaked sail  
**B** Circumference at forward end of flaked sail

# DO-IT-YOURSELF BAG KITS



## A SHEET BAG KIT

Organize, air out, and keep sheets or other items up out of the way. Phifertex mesh (p.77) front pocket with elastic top keeps items secure. Durable Sunbrella backing and adhesive-backed YKK SNAD fastener attachment to boat. Bag size: 21"W x 17"H. Kit makes 4 sheet bags.

**Kits Include:** Sunbrella (select color on p.14-18 or use pull down menu if ordering online), white Phifertex, binding, thread, elastic, snap fastener sockets and buttons, YKK adhesive-backed SNADs, snap fastener installation tool, and instructions.  
#103505 \$79.25 KIT



## SAIL DUFFEL BAG KITS

Store your sails safely out of the way. Features durable 8 oz. nylon and traditional drawstring closure.

**Kits Include:** 8 oz. nylon (select color on p.80 or use pull down menu if ordering online), leech line, hembobs, barrel lock closure, and instructions.

- C Small (22"W x 26"H) #103506 \$16.20 KIT
- D Medium (22"W x 46"H) #103507 \$26.15 KIT
- E Large (25"W x 58"H) #103508 \$36.70 KIT



## F CARRY-ALL TOTE BAG KIT

Perfect for hauling supplies to the boat or shopping trips at your favorite ports. Features side pockets for additional storage. Finished bag size: 13"W x 13.5"H.

**Kits Include:** Sunbrella (select color on p.14-18 or use pull down menu if ordering online), thread, webbing, binding, and instructions.  
#103511 \$26.25 KIT



## G DITTY BAG KIT

Learn various hand sewing techniques used in traditional sailmaking while constructing this bag. Great way to hold small items and sewing notions.

**Kits Include:** Cotton duck, twine, thread, manila twisted rope, thimble, composition wax, hand sewing needle, and marking pencil. Instructions not included but can be found in *The Sailmaker's Apprentice* (#3142, p.239).  
#5628A \$48.15 KIT

## B TOTE BAG KITS

Great for weekend cruises! Large enough to hold several sets of clothing, yet collapsible and easy to store. Features zipper closure and storage pocket. Available with Sunbrella (select color from p.14-18) or 4 oz. nylon material (select color from p.80). Finished size: 26.5" L x 11" Dia.

**Kits Include:** Selected fabric, webbing, white continuous zipper and slider, hook and loop, hembobs, and instructions.

Sunbrella Kit #103509 \$33.00 KIT

4 oz. Nylon Kit #23.00 KIT

Blue #107170 White #107174

Red #107173 Black #107172

Orange #107171

+ Shoulder Strap Kit (1" nylon webbing)  
#131298 \$9.25 KIT

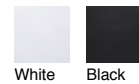

## SPINNAKER LAUNCHING BAG KITS

Hoist your spinnaker quickly and easily. Hoop keeps the mouth of the bag open for easy loading and launching. Shock cord secured lid keeps bag tightly closed until halyard is pulled to launch the spinnaker. Attaches to the foredeck with two nylon snaps.

### KITS INCLUDE:

4 oz. nylon (select color below or use pull down when ordering online), hoop, thread, shock cord, snap pistons, webbing, basting tape, hand needle, twine, and instructions.



SPINNAKER SIZE (SQ. FT.)	DIAMETER	HEIGHT (MAX.)	PART #	PRICE
100-300	12"	30"	#320400	\$62.25 KIT
300-700	16"	37"	#320410	\$64.25 KIT
700-1000	20"	37"	#320420	\$73.45 KIT
> 1000	24"	37"	#320430	\$87.65 KIT



## SHROUD TURNBUCKLE COVER KITS

Protect sails and skin against abrasion from turnbuckles and cotter pins with a traditional leather cover. Assembly time: 10 minutes.

**KITS INCLUDE:** Sailmaker's leather, hook and loop, leech line, hembobs, and instructions.  
Small - 4" x 4.5" x 12" #6451A \$16.50 KIT  
Medium - 5" x 5.5" x 17" #6452A \$16.95 KIT  
Large - 6" x 7" x 21" #6453A \$27.90 KIT

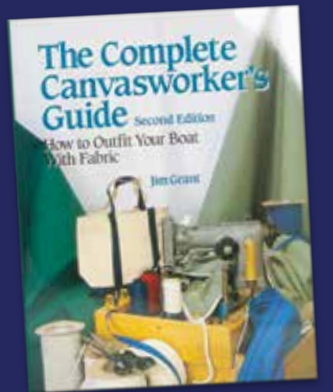

## THE COMPLETE CANVASWORKER'S GUIDE

by Jim Grant, 186 pp. Soft cover.

Great ideas and thorough step-by-step instructions to make canvas projects easy and enjoyable. This edition features polished, tested techniques with detailed illustrations.

**Topics Include:** Principles of canvaswork, sea anchors, awnings, enclosures, bags, biminis, boat covers, bosun's chairs, cushions, dodgers, flags, pennants, harnesses, sail covers, small covers, spinnaker socks, weathercloths, and wind scoops.

#35101 \$19.95 EA

## THE SAILMAKER'S APPRENTICE

by Emiliano Marino, 494 pp. Soft cover.

Techniques and tips for traditional sail design, construction, repair, and improvement. Also covers rigs and sail types. Serves as an excellent foundation and includes 700 great illustrations. Perfect for anyone wanting to cruise with self-reliance.  
#3142 \$27.95 EA

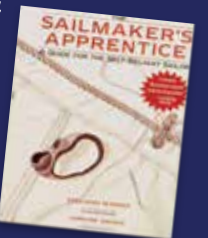

## THE BIG BOOK OF BOAT CANVAS

by Karen Lips, 242 pp. Soft cover.

Complete, comprehensive guide to boat canvas combining two popular volumes, *Boat Canvas Cover to Cover & More Boat Canvas*, into one. Step-by-step instructions on 36 projects ranging from sail covers, dodgers, and duffel bags to interior cushions, privacy curtains, and hanging lockers. Includes over 300 illustrations.  
#37308 \$19.95 EA





## TILLER COVER KIT

Sew your own Sunbrella® tiller cover with drawstring and barrel lock opening. Pre-patterned for 36", 48", or 55" sizes but can easily be adjusted to fit your exact tiller length. Max. circumference: 11.5" (tapers to 8" end). Assembly time: 30 min.

**KIT INCLUDES:** Sunbrella fabric (select 60" color p.12-16 or use the pull down menu if ordering online), thread, leech line, barrel lock closure, and instructions.

#6459 \$32.60 KIT



## BOSUN'S CHAIR KIT

Construct a padded bosun's chair large enough to support up to 250 lb! Extremely safe, very comfortable, and flexible. Connect the completed bosun's chair to a halyard and use a winch to hoist up mast. Use with a Sailrite Safety Harness (p. 244) connected to a separate halyard as a secondary safety line. Features a side pocket for storage, tool loops, and a D-Ring that could be used to direct the chair from the deck.

### KIT INCLUDES:

Sunbrella fabric (select color on p.14-18 or use pull down menu if ordering online), binding, stainless hardware, Ensolite closed-cell foam pad, webbing, thread, Velcro, and instructions.  
#323024 \$87.55 KIT

## HARKEN BOSUN'S CHAIR

Safe, reliable bosun's chair for sailors that is both high-strength and lightweight. Wide seat provides secure platform and low halyard attachment gives sailors more room to work on the boat. Heavy-duty polyester canvas with a 1" foam padding ply seat. Includes adjustable safety belt and two wide mouthed pockets and d-rings for tools. Carrying case included.

### FEATURES:

- Extra wide padded seat: 18"W x 12"L
- Adjustable back support
- High-strength webbing (3,000 lb per inch)
- Ballistic nylon construction
- Stainless steel triangle attachments
- Two webbing attachment points per side
- Downhaul attachment on bottom of chair
- Made in the USA

**Note:** This item cannot be sold outside the United States.

#103231 MSRP-\$207.40 \$182.99 EA



## ATN MASTCLIMBER

Safely and quickly hoist yourself up the mast using only leg muscles even when the boat is heeled. The ATN Mastclimber is a hard seat with back rest and one-way jammer and leg straps with foot loops and one-way jammer. Features anodized aluminum and stainless steel mast ascenders that fit OVER a taught 3/8"-5/8" halyard line. No need for knots, static lines, or unattaching shackles. Simply fit over the line, twist, and secure with the pin.

To use, stand up on the two leg straps, slide up the one-way jammer of the chair seat, sit down, and slide up the one-way jammer of the leg strap. Repeat until the desired height is reached. Reverse the procedure to descend the mast. From start to finish, the Mastclimber makes ascending the mast easier than ever and you can do it alone! Max waist size: 50".

#101610 MSRP-\$450.00 \$399.00 EA



## WINCH COVER KIT

Protect your winch from rain, dust, and other damaging elements. Features Sunbrella fabric and elastic cord for a secure fit. Also great as compass covers. Enough fabric to make 4 - 7" Dia x 9" H or 8 - 5" x 6" winch covers.

**KIT INCLUDES:** Sunbrella 60" fabric (select color on p.14-18 or use pull down menu if ordering online), UV thread, shock cord, and instructions to make any winch cover size.

#103504 \$30.90 KIT

## FENDER COVER KIT

Tough enough for a fender cover but soft enough to be near the sides of your boat. Solution-dyed polyester Boat Blanket (p.87) features excellent resistance to sun rot, chemicals, and mildew while staying colorfast, soft, and resilient. Build 4 large fender covers (34" Cir x 36"L) OR 6 medium fender covers (34" x 24") OR 16 small fender covers (16" x 18") with one kit! Great to use for other protective covers.

**KIT INCLUDES:** 72" x 72" Boat Blanket fabric (select color on p.87 or use pull down menu if ordering online), thread, Velcro (hook side only), and instructions.

#103503 \$49.85 KIT

# SERIES DROGUE ESSENTIAL TO BOAT SAFETY

The Series Drogue, as conceived by Don Jordan, was designed in collaboration with U.S. Coast Guard researchers after tests showed conventional sea anchors were subject to fatigue failure as the single large fabric parachute would fill with water and then collapse under the strains generated by storm waves.

The Series Drogue looks like a parade of jellyfish in single file, but is really 100 or more 5" diameter nylon sailcloth cones attached every 20 inches along a long rope. The design ensures the cones will fill and grab hold of water keeping the boat properly positioned for the next wave strike (best capsizes prevention for breaking waves). Proper boat position is "stern to" or running with oncoming waves, lessening the relative speed of the on-rushing walls of water.

The design is steadier and ensures that boat fittings are under a more-constant load and less likely to get destroyed. In simulated fatigue testing, the drogue was subjected to 15,000 cycles (the equivalent of a giant hurricane) without a failure. A 15–50 lb anchor attached to the end of the line keeps the drogue from popping out of the water, a common problem with conventional sea anchors.

Deployment and retrieval from the water is easy and in most cases can be done hand-over-hand. A winch can be used for retrieval in extremely difficult storm conditions (drogues can compress around winch without damage).

The U.S. Coast Guard development team hopes that boaters will add this easily made and stored device to their boat's inventory of safety equipment.



## Now With Heavier Fabric! SERIES DROGUE KITS

### A SERIES DROGUE CONE KIT

Cones are computer plotted and precut for easy sewing and construction. Includes 3.3 oz. White Nylon Sailcloth precut cones, 3/4" nylon tape, thread, basting tape, latch hook, and instructions. Refer to the chart on p.243 to determine quantity of cones required based on boat displacement.

#### \*Items needed (sold separately):

Nylon double braid line (refer to USCG recommendations), splicing tool (for eye splices in line - Sailrite recommends Brion Toss splicing tools p.222), thimble (p.215), bridle, and anchor (not available at Sailrite).



### B SERIES DROGUE COMPLETE KIT

This expansion of the Cone Kit also includes line (quantity in chart) and a thimble (#3495, p.215) for the end of the Drogue.

#### \*Items needed (sold separately):

Bridle, splicing tool (for eye splices in line - Sailrite recommends Brion Toss splicing tools p.222), and anchor (not available at Sailrite).



### C DROGUE DEPLOYMENT BAG KIT

Quickly and safely get a drogue in the water during a storm! Roll-up bag design with elastic loops keep the drogue well organized and tangle-free. To deploy drogues, secure bag to the boat and throw the drogue anchor overboard! Roll up and secure with line ties for easy storage.

**Kits Include:** Pre-patterned Sunbrella 46" Marine Grade fabric (select color p.14-18 or use pull down menu if ordering online), thread, basting tape, tubular webbing, elastic, leech line, and instructions. Elastic placement marked during pre-patterning.

Up to 135 Cones **#102330 \$84.90 KIT**

Up to 170 Cones **#102334 \$103.40 KIT**

Up to 215 Cones **#102338 \$104.25 KIT**



## COAST GUARD RECOMMENDATIONS

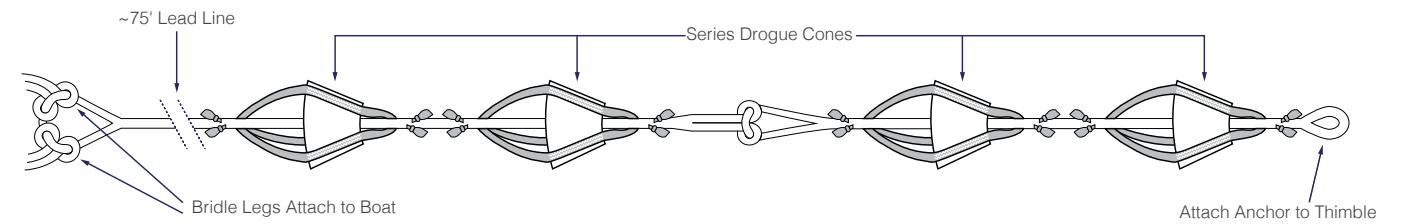

### LINE DIAMETER

Line size may be decreased near the end of the drogue due to diminishing stress. If more than one size is used, make each section equal in length.

### BRIDLE SPECIFICATIONS

Make from 3-strand line, double-braided line, or wire. Each bridle leg should be: 2.5 x Transom Width + 2 ft. (allowance for splicing and attachment to boat). Often the bridle is a different color so it can be located quickly. Line for bridle should match the strength of the largest line used in the drogue.

### ANCHOR SPECIFICATIONS

Use lead shot, chain, or scuba weights in lieu of traditional mushroom anchors. See anchor weight recommendations in chart.

## SERIES DROGUE SPECIFICATIONS

Based on Coast Guard Recommendations

### MONOHULL

DISPLACEMENT	CONES	LINE LENGTH <sup>3</sup>	LINE DIAMETER <sup>2</sup>	ANCHOR WEIGHT	A CONE KIT ONLY		B COMPLETE KIT	
N/A	10	-	-	-	#102174 <sup>1</sup>	\$36.25 KIT	-	-
10,000 lb.	100	246 ft.	5/8"	15 lb.	#8600	\$355.90 KIT	#8613	\$855.25 KIT
15,000 lb.	107	258 ft.	5/8"	15 lb.	#8601	\$378.65 KIT	#8614	\$911.95 KIT
20,000 lb.	116	139 / 139 ft.	3/4", 5/8"	15 lb.	#8602	\$407.90 KIT	#8615	\$1,078.50 KIT
25,000 lb.	124	145 / 146 ft.	3/4", 5/8"	25 lb.	#8603	\$433.90 KIT	#8616	\$1,137.40 KIT
30,000 lb.	132	152 / 152 ft.	3/4", 5/8"	25 lb.	#8604	\$469.85 KIT	#8617	\$1,191.60 KIT
35,000 lb.	139	158 / 158 ft.	3/4", 5/8"	25 lb.	#8605	\$492.60 KIT	#8618	\$1,242.55 KIT
40,000 lb.	147	111 / 111 / 112 ft.	1", 3/4", 5/8"	30 lb.	#8606	\$518.60 KIT	#8619	\$1,515.85 KIT
45,000 lb.	156	116 / 116 / 117 ft.	1", 3/4", 5/8"	40 lb.	#8607	\$547.85 KIT	#8620	\$1,593.55 KIT
50,000 lb.	164	121 / 121 / 121 ft.	1", 3/4", 5/8"	50 lb.	#8608	\$573.85 KIT	#8621	\$1,662.05 KIT

### MULTIHULL

DISPLACEMENT	CONES	LINE LENGTH <sup>3</sup>	LINE DIAMETER <sup>2</sup>	ANCHOR WEIGHT	A CONE KIT ONLY		B COMPLETE KIT	
6,000 lb.	130	296 ft.	5/8"	15 lb.	#8609	\$463.35 KIT	#8622	\$1,062.70 KIT
12,000 lb.	140	312 ft.	5/8"	15 lb.	#8610	\$495.85 KIT	#8623	\$1,127.20 KIT
18,000 lb.	150	167 / 167 ft.	3/4", 5/8"	15 lb.	#8611	\$528.35 KIT	#8624	\$1,324.55 KIT

<sup>1</sup> 10 cone kit does not include latch hook, splicing tool, thread, or basting tape. Items sold separately.

<sup>2</sup> See Coast Guard Recommendations.

<sup>3</sup> Line length includes approximately 75 ft. lead line. Lines are not pre-spliced. Bridle line is not included in chart (refer to USCG recommendations).

\*Complete USCG Series Drogue Findings & Recommendations available online under any Sailrite drogue kit or call The National Technical Information Service, US Dept. of Commerce (1-888-584-8332) to request Document #ADA 188 598.

### SAILRITE SUGGESTION

We recommend reinforcing the mouth of the drogue cones with Black Nylon Tape 3/4" (p.152). Tape for reinforcing is sold separately. See Sailrite.com for the exact amount needed for your kit.



## SAFETY TETHER KITS

Increase safety while moving about onboard. Hook your harness directly to the boat with this expandable tether design. Tether features tubular webbing and elastic for a design that stretches up to 2 meters and retracts when not under tension to keep from being underfoot.

**Kits Include:** 2" tubular webbing, Suncor hardware, thread, elastic, and instructions.

### SINGLE TETHER

One length of webbing with hooks on both ends.

**A Single Tether Kit #850100 \$45.95 KIT**

### DOUBLE TETHER

Stay attached at all times! Lengths of webbing with hooks on all three legs. Always keep short leg attached to your harness and use the other two expandable legs to leapfrog from one location to another.

**B Double Tether Kit #849100 \$72.45 KIT**

### SAILRITE SAFETY HARNESS KIT

Everything you need to build a safe and comfortable safety harness! What we believe to be the best safety harness available, this harness is easy to adjust for different size sailors. Use with safety tethers. Add a webbing tab for attaching a whistle, EPIRB, or knife.

**Kits Include:** 2" tubular webbing, non-magnetic stainless hardware, buckles, hembobs, 1" tubular webbing (indicator tab), and instructions.

**C #54389A \$35.85 KIT**



◀ Download **FREE** instructions (#X-HT-200291) to make your own jackline at [Sailrite.com](http://Sailrite.com)



### INTERNATIONAL SIGNAL FLAG KIT

A fun and economical way to make 40 international signal flags including complete alphabet, numbers, repeaters, and answering pennants. Features pre-patterned nylon flag material (red, white, blue, black, and yellow), webbing reinforcements along hoist edge, and loops for corner attachment. Finished flag size: 24"L x 18"W.

**Kits Include:** 4 oz. nylon flag cloth, thread, webbing, basting tape, and instructions.

**#421A \$135.80 KIT**

### FLAG CONSTRUCTION TAPE

Add strength and reinforcement for grommets. Use along hoist edge (or all edges). Pre-folded with finished edges. Sandwich over flag edge and sew. Cotton duck / polyester blend. White.

1.5" width (folded) **#510134**

1-149 **\$0.40/FT** 150+ **\$0.36/FT**

2" width (folded) **#100260**

1-149 **\$0.50/FT** 150+ **\$0.45/FT**



### SNAP CLIP FOR FLAGS

Attach to line and snap onto webbing at top and bottom of flag. All the characteristics of metal snaps with the advantages of thermoplastic material. Nylon. Black. Attachment hole: 3/8".

**#93825 \$2.80 PK10**

## CARIBBEAN SIGNAL & COURTESY FLAGS BOOK

by *Bonnie Ladell & Matthew Grant*

Sailrite's exclusive "Make Your Own Signal & Courtesy Flags" book offers patterns and instructions on how to make and fly all 28 Caribbean courtesy flags, as well as 40 international signal flags. Includes complete alphabet, numbers, repeaters, and answering pennant patterns with easy to follow construction techniques. Spiral bound for flat and easy patterning. 64 pp.

**#39056 \$19.95 EA**

*Materials needed to make all Caribbean Courtesy flags in this book:*

**60" NYLON FLAG CLOTH 4 OZ.** (p.80)

- Red (#1002) - 3 yd.
- Blue (#1003) - 3 yd.
- White (#1001) - 3 yd.
- Yellow (#1005) - 2 yd.
- Black (#10001) - 1 yd.
- Green (#1004) - 1 yd.
- Light Blue (#103049) - 1 yd.

**54" ADHESIVE-BACKED INSIGNIA** (p.83)

- Red (#943) - 1 yd.
- White (#945) - 1 yd.

**1" NYLON WEBBING** (p.148)

- White (#22303) - 30 ft

**DIE SET & PLAIN GROMMET** (p.198)

- #1 (#26301) - 1 set

**PLAIN GROMMET BRASS** (p.196)

- #1 (#26304) - 3 packs

**V-46 THREAD** (p.130)

- White 1 oz. (#20202) - 1 cone

See the International Signal Flag Kit (#421A) at [Sailrite.com](http://Sailrite.com) for signal flag materials.



# THREAD & NEEDLE RECOMMENDATIONS

	HOME MACHINE								INDUSTRIAL MACHINE													
	NEEDLE POINT	NEEDLE SIZE	V-30 POLY	V-46 POLY	V-69 POLY	V-69 UV NYLON	TENARA*	PROFLEN® PTFE*	MONOFILAMENT	NEEDLE SIZE	V-30 POLY	V-46 POLY	V-69 POLY	V-69 UV NYLON	V-92 POLY	V-92 UV NYLON	V-138 POLY	TENARA*	HEAVY TENARA*	PROFLEN PTFE*	MONOFILAMENT	
Allsport Vinyl	Sharp	#18			✓					#18					✓	✓						
Bag/Flag Nylon	Sharp	#14		✓						#14		✓										
Bag Mesh	Sharp	#16			✓					#16					✓							
Boat Blanket	Sharp	#18			✓		✓	✓		#20					✓		✓	✓			✓	
Brun-Tuff Camo Vinyl	Sharp	#16			✓		✓	✓		#18					✓			✓			✓	
HullBlanket Headliner Hull Liner	Sharp	#18			✓					#20					✓							
Channeling Fabric	Sharp	#18			✓		✓	✓		#18					✓			✓			✓	
Chilewich	Sharp	N/A								#20					✓							
Cordura	Sharp	#16				✓	✓	✓		#16				✓				✓			✓	
Cotton Duck (Marine Finished)	Sharp	#18				✓				#18					✓							
Cotton Duck (#8)	Sharp	#20			✓					#20					✓							
Cushion Underlining	Sharp	#18			✓	✓		✓		#18-20		✓	✓	✓	✓	✓						✓
Dacron (4 oz)	Sharp	#16			✓		✓	✓		#16		✓						✓			✓	
Dacron (4.4-10.4 oz.)	S,DI,SD1	#16, 18			✓		✓	✓		#18-22					✓			✓			✓	
Dry Leather & Sailmaker's Leather	DI	N/A								#18-23					✓	✓	✓					
Evolution	Sharp	#16			✓					#16			✓									
Fiberglass Mesh	Sharp	#16			✓					#18-20					✓			✓			✓	
Geobella	Sharp	#16			✓	✓				#16			✓	✓		✓						
Headliner	Sharp	#18			✓			✓		#18			✓									✓
Herculite Riviera	Sharp	#18			✓		✓	✓		#20					✓			✓			✓	
Infinity	Sharp	N/A								#20					✓							
Marine Topping	Sharp	#18			✓		✓	✓		#20					✓			✓			✓	
Morbern Shock & Hexx	Sharp	#18			✓		✓	✓		#20					✓			✓			✓	
Mosquito Netting	Ball	#14	✓							#14	✓											
Naugahyde	Sharp	#18			✓		✓	✓		#20					✓			✓			✓	
Nauga Soft	Sharp	#18			✓	✓				#18			✓	✓								
Odyssey	Sharp	#18			✓		✓	✓		#18					✓			✓			✓	
Phifertex & Plus	Sharp	#18			✓		✓	✓		#20					✓			✓			✓	
Polyester Mesh	Sharp	#14		✓						#14		✓										
Seabrook	Sharp	#18			✓		✓	✓		#20					✓			✓			✓	
SeaMark™	Sharp	#18			✓		✓	✓		#18					✓			✓	✓	✓	✓	
Shelter-Rite	Sharp	#18			✓		✓	✓		#20					✓		✓	✓	✓	✓	✓	
Softouch	Sharp	#18			✓		✓	✓		#18					✓			✓			✓	
Spinnaker Cloth (0.5-.75 oz.)	Sharp	#12	✓							#12	✓											
Spinnaker Cloth (1.5 oz. & Over)	Sharp	#16		✓						#16		✓										
Stamoid®	Sharp	#18			✓		✓	✓		#20					✓			✓			✓	
Sunbrella® Marine, Awning/Shade	Sharp	#18			✓		✓	✓		#20					✓			✓	✓	✓	✓	
Sunbrella® Upholstery Fabric	Sharp	#16			✓	✓				#16			✓	✓								
Sunforger® Car Cover Flannel	Sharp	#18			✓	✓				#18			✓	✓								
Sur Last™	Sharp	#18			✓		✓	✓		#18					✓			✓			✓	
Targa Premium Canopy	Sharp	#18			✓		✓	✓		#18					✓			✓			✓	
Tramp Mesh	S, DI	#20			✓		✓	✓		#20					✓		✓	✓	✓	✓	✓	
Top Gun	Sharp	#18			✓		✓	✓		#20					✓			✓	✓	✓	✓	
Top Gun 1S	Sharp	#18			✓		✓	✓		#20					✓			✓	✓	✓	✓	
Top Notch 9	Sharp	#18			✓		✓	✓		#20					✓			✓	✓	✓	✓	
Ultraleather™	Sharp	#18				✓			✓	#18				✓								✓
Ultrasuede HP	Ball	#18				✓		✓		#18				✓								✓
Weblon Regatta	Sharp	#16			✓		✓	✓		#18					✓	✓		✓			✓	
Window Material 12 & 20 Gauge	Sharp	#16			✓					#18-20			✓									
Window Material 30 & 40 Gauge	Sharp	#18			✓		✓	✓		#20					✓			✓			✓	

## TYPES OF THREAD:

### BONDED UVR POLYESTER:

The industry standard with high strength, controlled stretch, stability in sunlight, and resistance to needle heat, abrasion, salt-water and mildew. Seldom frays at the needle eye. Bonded finish increases consistency and reduces machine tension adjustments.

### BONDED UV NYLON:

Designed for medium to heavy upholstery fabric, plastic, tarpaulin, and leather. High tensile strength and abrasion resistance. Not recommended for outdoor use.

### PTFE LIFETIME THREAD:

Proven to be unaffected by exposure to UV radiation, cleaning agents, pollution, saltwater, air, rain and snow. Worth the extra expense if working in warmer climates or leaving canvas projects outside year round. Sailrite offers Tenara® & Profilen® and recommends using a #14 or #16 needle with regular Tenara & Profilen thread or a #19 or #20 with Heavy Tenara thread.

### MONOFILAMENT:

Used primarily in upholstery work. Very strong and sews well (easy to set upper thread tension and tension remains consistent). Clear to blend in with fabric.

Ball = Ballpoint

DI = Diamond Point

S = Sharp

SD1 = Cutting/Sharp

\*Use a #14 or #16 needle with Tenara thread or a #19 or #20 with Heavy Tenara thread. Profilen works best with a #18 or #20 needle.

# RECOMMENDED THREAD COLORS FOR SUNBRELLA® MARINE FABRIC

These 15 Sunbrella Marine Fabric colors have a Sunstop thread that is an exact color match.

SUNBRELLA® FABRIC		V-69 POLYESTER		V-92 POLYESTER		TENARA®		PROFILEN®	
COLOR	ITEM #	COLOR	ITEM #	COLOR	ITEM #	COLOR	ITEM #	COLOR	ITEM #
Black	#4608, #6008, #8408	Black	#105425	Black	#100071	Black	#104123, #103317	Black	#107130, #107131
Cadet Grey	#4630, #6030, #8430	Cadet Grey	#106141	Cadet Grey	#106388	Clear	#16211, #103320	Clear	#107128, #107129
Beige	#4620, #6020	Beige	#106015	Beige	#106390	Clear	#16211, #103320	Clear	#107128, #107129
True Brown	#4621, #6021	True Brown	#106018	True Brown	#106391	Clear	#16211, #103320	Clear	#107128, #107129
Linen	#4633, #6033	Linen	#106144	Linen	#105430	Clear	#16211, #103320	Clear	#107128, #107129
Natural	#4604, #6004, #8404	Natural	#106135	Natural	#106386	White	#10011, #103315	Clear	#107128, #107129
Silver	#4651, #6051	Silver	#106138	Silver	#106387	Clear	#16211, #103320	Clear	#107128, #107129
Toast	#4628, #6028, #8428	Toast	#106147	Toast	#106389	Sandstone	#104985	Clear	#107128, #107129
Captain Navy	#4646, #6046, #8446	Captain Navy	#105999	Captain Navy	#106394	Navy Blue	#121215	Clear	#107128, #107129
Navy	#4626, #6026	Navy	#106002	Navy	#100073	Navy Blue	#121215	Clear	#107128, #107129
Pacific Blue	#4601, #6001, #8401	Pacific Blue	#106030	Pacific Blue	#106393	Pacific Blue	#100292	Clear	#107128, #107129
Forest Green	#4637, #6037, #8437	Forest Green	#106021	Forest Green	#105427	Forest Green	#121216	Clear	#107128, #107129
Burgundy	#4631, #6031, #8431	Burgundy	#106027	Burgundy	#105429	Clear	#16211, #103320	Clear	#107128, #107129
Jockey Red	#4603, #6003, #8403	Jockey Red	#105428	Jockey Red	#105447	Clear	#16211, #103320	Clear	#107128, #107129
Logo Red	#4666, #6066	Logo Red	#106024	Logo Red	#106392	Red	#121217	Clear	#107128, #107129

For the remainder of the fabrics, we have made thread color suggestions. White thread is always a good choice for any color. Remember that colored polyester thread, other than black, will fade over time.

SUNBRELLA® FABRIC		V-69 POLYESTER		V-92 POLYESTER		TENARA®		PROFILEN®	
COLOR	ITEM #	COLOR	ITEM #	COLOR	ITEM #	COLOR	ITEM #	COLOR	ITEM #
Charcoal Grey	#4644, #6044	Cadet Grey	#106141	Cadet Grey	#106388	Clear	#16211, #103320	Clear	#107128, #107129
Charcoal Tweed	#4607, #6007	Black	#105425	Black	#100071	Black	#104123, #103317	Black	#107130, #107131
Crest Ash	#4662	Cadet Grey	#106141	Cadet Grey	#106388	Clear	#16211, #103320	Clear	#107128, #107129
Silica Charcoal	#4897	Cadet Grey	#106141	Cadet Grey	#106388	Grey	#121218	Clear	#107128, #107129
Silica Stone	#4861	Cadet Grey	#106141	Cadet Grey	#106388	Clear	#16211, #103320	Clear	#107128, #107129
Slate	#4684	Black	#105425	Black	#100071	Black	#104123, #103317	Black	#107130, #107131
Smoke	#4615	Black	#105425	Black	#100071	Black	#104123, #103317	Black	#107130, #107131
Storm	#4636	Cadet Grey	#106141	Cadet Grey	#106388	Clear	#16211, #103320	Clear	#107128, #107129
Silica Gravel	#4833	Cadet Grey	#106141	Cadet Grey	#106388	Clear	#16211, #103320	Clear	#107128, #107129
Cocoa	#4676	Beige	#106015	Beige	#106390	Clear	#16211, #103320	Clear	#107128, #107129
Heather Beige	#4672, #6072	Beige	#106015	Beige	#106390	Clear	#16211, #103320	Clear	#107128, #107129
Linen Tweed	#4654, #6054	Seal Brown	#104338	Beige	#106390	Clear	#16211, #103320	Clear	#107128, #107129
Mocha Tweed	#4616	Toast	#106147	Toast	#106389	Clear	#16211, #103320	Clear	#107128, #107129
Silica Barley	#4858	Toast	#106147	Toast	#106389	Clear	#16211, #103320	Clear	#107128, #107129
Silica Sesame	#4860	Beige	#106015	Beige	#106390	Sandstone	#104985	Clear	#107128, #107129
Tan	#4614	Toast	#106147	Toast	#106389	Clear	#16211, #103320	Clear	#107128, #107129
Taupe	#4648, #6048	Cadet Grey	#106141	Cadet Grey	#106388	Clear	#16211, #103320	Clear	#107128, #107129
Tresco Birch	#4696	Seal Brown	#104338	Beige	#106390	Sandstone	#104985	Clear	#107128, #107129
Tresco Brass	#4658	Toast	#106147	Beige	#106390	Sandstone	#104985	Clear	#107128, #107129
Tresco Linen	#4695, #6095	Linen	#106144	Linen	#105430	Sandstone	#104985	Clear	#107128, #107129
Walnut Brown Tweed	#4618	True Brown	#106018	True Brown	#106391	Clear	#16211, #103320	Clear	#107128, #107129
Ember	#4659	True Brown	#106018	True Brown	#106391	Black	#104123, #103317	Black	#107130, #107131
White	#4634, #6034	White	#20235	White	#100079	White	#10011, #103315	Clear	#107128, #107129

SUNBRELLA® FABRIC		V-69 POLYESTER		V-92 POLYESTER		TENARA®		PROFILEN®	
COLOR	ITEM #	COLOR	ITEM #	COLOR	ITEM #	COLOR	ITEM #	COLOR	ITEM #
Crest Birch	#4660	Linen	#106144	Linen	#105430	Clear	#16211, #103320	Clear	#107128, #107129
Oyster	#4642, #6042, #8442	Silver	#106138	Silver	#106387	Clear	#16211, #103320	Clear	#107128, #107129
Parchment	#4683, #6083	Natural	#106135	Natural	#106386	Clear	#16211, #103320	Clear	#107128, #107129
Silica Dune	#4859	Linen	#106144	Natural	#106386	Clear	#16211, #103320	Clear	#107128, #107129
Silica Silver	#4862	Silver	#106138	Silver	#106387	Clear	#16211, #103320	Clear	#107128, #107129
Wheat	#4674, #6074	Toast	#106147	Toast	#106389	Clear	#16211, #103320	Clear	#107128, #107129
Capri	#4675, #6075	White	#20235	Blue Wave	#103030	Clear	#16211, #103320	Clear	#107128, #107129
Marine Blue	#4678, #6078	Derby Navy	#103795	Navy	#100073	Navy Blue	#121215	Clear	#107128, #107129
Mediterranean Blue	#4652, #6052	Derby Navy	#103795	Blue	#103033	Pacific Blue	#100292	Clear	#107128, #107129
Mediterranean Tweed	#4653, #6053	Navy	#106002	Blue	#103033	Navy Blue	#121215	Clear	#107128, #107129
Ocean Blue	#4679, #6079, #8479	Derby Navy	#103795	Blue	#103033	Clear	#16211, #103320	Clear	#107128, #107129
Royal Blue Tweed	#4617, #6017, #8417	Pacific Blue	#106030	Pacific Blue	#106393	Pacific Blue	#100292	Clear	#107128, #107129
Sapphire Blue	#4641	White	#20235	Blue Wave	#103030	Clear	#16211, #103320	Clear	#107128, #107129
Sky Blue	#4624, #6024	White	#20235	Blue Wave	#103030	Clear	#16211, #103320	Clear	#107128, #107129
Sea	#4664	White	#20235	White	#100079	Clear	#16211, #103320	Clear	#107128, #107129
Spa	#4673, #6073	White	#20235	White	#100079	Clear	#16211, #103320	Clear	#107128, #107129
Azure	#4669, #6069	Pacific Blue	#106030	Blue Wave	#103030	Clear	#16211, #103320	Clear	#107128, #107129
Silica Caribbean	#4831	Pacific Blue	#106030	Pacific Blue	#106393	Pacific Blue	#100292	Clear	#107128, #107129
Aruba	#4612, #6012	White	#20235	Scarab	#103035	Clear	#16211, #103320	Clear	#107128, #107129
Aquamarine	#4623, #6023, #8423	White	#20235	Scarab	#103035	Clear	#16211, #103320	Clear	#107128, #107129
Aspen	#4668	White	#20235	White	#100079	Clear	#16211, #103320	Clear	#107128, #107129
Basil	#4688	White	#20235	White	#100079	Clear	#16211, #103320	Clear	#107128, #107129
Erin Green	#4600	Spruce Green	#103321	White	#100079	Clear	#16211, #103320	Clear	#107128, #107129
Fern	#4671	Spruce Green	#103321	White	#100079	Clear	#16211, #103320	Clear	#107128, #107129
Ginkgo	#4685	White	#20235	White	#100079	Clear	#16211, #103320	Clear	#107128, #107129
Hemlock Tweed	#4605, #6005	Forest Green	#106021	Forest Green	#105427	Black	#104123, #103317	Black	#107130, #107131
Ivy	#4632, #6032	Forest Green	#106021	Forest Green	#105427	Black	#104123, #103317	Clear	#107128, #107129
Persian Green	#4643, #6043, #8443	White	#20235	Scarab	#103035	Clear	#16211, #103320	Clear	#107128, #107129
Seagrass Green	#4645	Spruce Green	#103321	White	#100079	Clear	#16211, #103320	Clear	#107128, #107129
Silica Sage	#4896	White	#20235	White	#100079	Clear	#16211, #103320	Clear	#107128, #107129
Turquoise	#4610, #6010	White	#20235	White	#100079	Clear	#16211, #103320	Clear	#107128, #107129
Buttercup	#4635	White	#20235	Sunflower	#103029	Clear	#16211, #103320	Clear	#107128, #107129
Sunflower Yellow	#4602, #6002	White	#20235	Sunflower	#103029	Clear	#16211, #103320	Clear	#107128, #107129
Orange	#4609	White	#20235	White	#100079	Clear	#16211, #103320	Clear	#107128, #107129
Rust	#4689	White	#20235	White	#100079	Clear	#16211, #103320	Clear	#107128, #107129
Tuscan	#4677	White	#20235	White	#100079	Clear	#16211, #103320	Clear	#107128, #107129
Black Cherry	#4640	Black	#105425	Black	#100071	Clear	#16211, #103320	Clear	#107128, #107129
Dubonnet Tweed	#4606, #6006, #8406	Black	#105425	Black	#100071	Black	#104123, #103317	Black	#107130, #107131
Mahogany	#4667	Burgundy	#106027	Burgundy	#105429	Clear	#16211, #103320	Clear	#107128, #107129
Terracotta	#4622, #6022	White	#20235	White	#100079	Clear	#16211, #103320	Clear	#107128, #107129
Tresco Brick	#4699	Burgundy	#106027	Burgundy	#105429	Clear	#16211, #103320	Clear	#107128, #107129
Tresco Clay	#4698	White	#20235	White	#100079	Clear	#16211, #103320	Clear	#107128, #107129
Concord	#4665, #6065	White	#20235	Concord	#103028	Clear	#16211, #103320	Clear	#107128, #107129



# FASTENER TOOL SELECTION GUIDE

STEP 1: CHOOSE A FASTENER		STEP 2: SELECT AN INSTALLATION TOOL (CHOOSE ONLY ONE TOOL PER FASTENER)			
KEY	NAME	PART #	PRES-N-SNAP #109011 p.175	SNAPRITE #104500 p.171	OTHER INSTALLATION TOOLS Mallet #68563 and rubber cutting block #378100 recommended for use with hole cutters and anvils
A	DOT® Snap Fastener Button Silver 11/64" Barrel	#333777	#931012*		#100949 + #102235 or #25204 + #102235 (p.167, 197)
A	DOT® Snap Fastener Button (colored), 3/16" Barrel	Chart p.169	#931012*		#100949 + #102235 or #25204 + #102235 (p.167, 197)
A	DOT® Snap Fastener Button Silver, 1/4" Barrel	#333010	#931012*		#100949 + #102235 or #25204 + #102235 (p.167, 197)
A	DOT® Snap Fastener Button Silver 5/16" Barrel	#333012	#931012*		#100949 + #102235 or #25204 + #102235 (p.167, 197)
B	DOT® Snap Fastener Normal Action Socket	#333050	#931022*	#104232*	#100949 or #25204 (p.167)
B	DOT® Snap Fastener Hard Action Socket	#333058	#931022*	#104232*	#100949 or #25204 (p.167)
C	DOT® Snap Fastener Standard Stud	#333100	#931037*	#104235* + #103754	#100949 or #25204 (p.167)
D	DOT® Snap Fastener & Pull The Dot Eyelet 1/4"	#333555	#931041*	#104226*	#100949 + #102235 or #25204 + #102235 (p.167, 197)
D	DOT® Snap & Pull The Dot Eyelet 5/16"	#333558	#931041*	#104226*	#100949 + #102235 or #25204 + #102235 (p.167, 197)
E	DOT® Snap Fastener Screw Stud 3/8", 8-15 Self-Tap	#333105	—	—	Phillips Screwdriver
F	DOT® Snap Fastener Screw Stud 5/8", 8-15 Self-Tap	#333110	—	—	Phillips Screwdriver
G	3/8" Machine Screw (10-32)	#333115	—	—	Phillips Screwdriver
G	5/8" Machine Screw (10-32)	#333118	—	—	Phillips Screwdriver
H	3/8" Machine Screw (8-32)	#333120	—	—	Phillips Screwdriver
I	5/8" Machine Screw (8-32)	#333125	—	—	Phillips Screwdriver
J	DOT® Snap Fasteners Gypsy Stud 3/16" Barrel	#333130	#100899	—	#100949 + #102235 or #25204 + #102235 (p.167, 197)
K	3/4" Windshield Clip	#333135	—	—	No Tool Needed
K	7/8" Windshield Clip	#333138	—	—	No Tool Needed
L	DOT® Lift The Dot 2 Prong Stud	#888005	—	—	#100972 (p.177) + #120445 (p.174)
M	DOT® Lift The Dot Washer	#888010	—	—	Flathead Screwdriver
N	DOT® Lift The Dot Socket (Standard Legs)	#888015	—	—	#110012 (p.173) or #100695 (p.173) + #120445 (p.174)
N	DOT® Lift The Dot Socket (Extended Legs)	#888017	—	—	#110012 (p.173) or #100695 (p.173) + #120445 (p.174)
O	DOT® Lift The Dot Backplate	#888020	—	—	Flathead Screwdriver
P	DOT® Lift The Dot Screw Stud 1/2"	#888025	—	—	Wrench
Q	DOT® Lift The Dot Machine Screw Stud 3/8"	#888030	—	—	Wrench
Q	DOT® Lift The Dot Machine Screw Stud 5/8"	#888035	—	—	Wrench
R	DOT® Pull The Dot (One Way) Snaps - Button	#555777	#931012*	—	#100949 + #102235 or #25204 + #102235 (p.167, 197)
S	DOT® Pull The Dot (One Way) Snap - Socket	#555050	#586325	#104232*	#100949 + #25204 (p.167)
T	DOT® Pull The Dot (One Way) Snap	#555100	#931037*	#104235*	#100949 + #102235 or #25204 + #102235 (p.167, 197)
V	DOT® Pull The Dot (One Way) Snap - Screw Stud 3/8"	#555105	—	—	Phillips Screwdriver
W	DOT® Common Sense Barrel Stud	#104803	#104993	—	—
X	DOT® Common Sense Backplate For Barrel Stud	#104804	#104993	—	—
Y	DOT® Lift The Dot Eyelet-Type Base Stud	#888050	#106397	—	—
Y	DOT® Lift The Dot Long Eyelet-Type Base Stud	#888055	#106397	—	—
Z	DOT® Lift The Dot Eyelet-Type Base Washer	#888060	#106397	—	—
AA	DOT® Common Sense Fastener Eyelet	#777005	—	—	#108001 (p.177) or #100696 (sailrite.com) + #120445 (p.174)
AA	DOT® Common Sense Fastener Eyelet (Extended Legs)	#777006	—	—	#108001 (p.177) or #100696 (sailrite.com) + #120445 (p.174)
BB	DOT® Common Sense Washer	#777010	—	—	Flathead Screwdriver

\* Included with tool kit  
 \*\* Only sold in kits, not individual sale  
 \*\*\* Loxx® is compatible with the German TENAX® version and it not compatible with the English TENAX® products.

Cloth-To-Cloth (C-C) | Cloth-To-Surface (C-S)

KEY	NAME	PART #	PRES-N-SNAP #109011 p.175	SNAPRITE #104500 p.171	OTHER INSTALLATION TOOLS Mallet #68563 and rubber cutting block #378100 recommended for use with hole cutters and anvils
CC	DOT® Common Sense 2 Prong Stud	#777015	—	—	#100972 (p.177) + #120445 (p.174)
DD	DOT® Common Sense Fastener Clinch Plate	#777020	—	—	—
EE	DOT® Common Sense Fastener 5/8" Screw Stud	#777025	—	—	#120751 (174), #100135 (p.177) or Wrench
FF	DOT® Common Sense Fastener 2 Screw Stud	#777030	—	#104477	#102235 (p.197) or #104482 (p.197) + #100949 (C-C) (p.167) or #25204 (C-C) (p.167) or Phillips Screwdriver (C-S) or #103543 (C-C) (p.177)
GG	DOT® Common Sense 2 Screw Stud Double High	#777035	—	#104477	#102235 (p.197) or #104482 (p.197) + #100949 (C-C) (p.167) or #25204 (C-C) (p.167) or Phillips Screwdriver (C-S) or #103543 (C-C) (p.177)
II	Screw Flat Head 6 x 1/2"	#777040	—	—	Phillips Screwdriver
JJ	DOT® Common Sense Oversized Washer	#777045	—	—	No tool Needed
KK	DOT® Common Sense Plastic Reinforced Washer	#777050	—	—	No Tool Needed
LL	Loxx® Pull It Up Fastener Upper Head with Regular Washer***	#121356	—	—	#18211 + #121357 (p.179) or #121358 (p.179)
MM	Loxx® Pull It Up Fastener Upper Head with Long Washer***	#121355	—	—	#18211 + #121357 (p.179) or #121358 (p.179)
NN	Loxx® Pull It Up Fastener Lower Stud with Regular Washer***	#121349	—	—	#18211 + #121357 (p.179) or #121358 (p.179)
OO	Loxx® Pull It Up Fastener Lower Stud with Long Washer***	#121348	—	—	#18211 + #121357 (p.179) or #121358 (p.179)
PP	Loxx® Pull It Up Fastener 5/8" Self-Tapping Screw Stud***	#121353	—	—	Wrench
QQ	Loxx® Pull It Up Fastener 1/2" Self-Tapping Screw Stud***	#121354	—	—	Wrench
RR	Loxx® Pull It Up Fastener 1-3/8" Oval Plate Stud***	#121350	—	—	Screwdriver
SS	Loxx® Pull It Up Fastener 1" Oval Plate Stud***	#121351	—	—	Screwdriver
TT	Loxx® Pull It Up Fastener 3/8" Machine Screw Stud***	#121352	—	—	Wrench
UU	Nut Stainless Steel***	#121360	—	—	Wrench
VV	DOT® Lift The Dot Double Height Machine Screw Stud	#888075	—	—	Wrench
WW	DOT® Lift The Dot Double Height Stud Two Hole Base	#888070	—	—	Screwdriver
XX	Lift The Dot Fastener Standard Height Stud Two Hole Base	#888065	—	—	Screwdriver
SRA	SnapRite® Snap Fastener Button Silver 11/64" Barrel	#104151	#931012*	#104229*	#100949 + #102235 or #25204 + #102235 (p.167, 197)
SRA	SnapRite® Snap Fastener Button Silver 1/4" Barrel	#104154	#931012*	#104229*	#100949 + #102235 or #25204 + #102235 (p.167, 197)
SRA	SnapRite® Snap Fastener Button Silver 11/64" Barrel	#104151	#931012*	#104229*	#100949 + #102235 or #25204 + #102235 (p.167, 197)
SRG	SnapRite® Snap Fastener Button Silver 5/32" Barrel	#104153	#931012*	#104229*	#100949 (p.167) + #102235 (p.197)
SRG	SnapRite® Snap Fastener Button Silver 1/4" Barrel	#444004	#931012*	#104229*	#100949 (p.167) + #102235 (p.197)
SRJ	SnapRite® Gypsy Stud 3/16" Barrel	#104236	#100899	#104235*	#100949 + #102235 or #25204 + #102235 (p.167, 197)
SRR	SnapRite® Pull The Dot (One Way) Snap Button 1/4" Barrel	#104299	#931012*	#104229*	#100949 + #102235 or #25204 + #102235 (p.167, 197)
SSA	DOT® Snap Fastener Button 11/64"	#444777	#931012*	—	#100949 (p.167) + #102235 (p.197)
SSA	DOT® Snap Fastener Button 1/4" Barrel	#444888	#931012*	—	#100949 (p.167) + #102235 (p.197)
SSB	DOT® Snap Fastener Normal Action Socket (Stainless)	#444050	#931022*	#104232*	#100949 (p.167)
SSC	DOT® Snap Fastener Stud Cloth-to-Cloth (Stainless)	#444100	#931037*	#104235* + #103754	#100949 (p.167)
SSD	DOT® Snap Fastener Eyelet (Stainless)	#444555	#931041*	#104226*	#100949 (p.167) + #102235 (p.197)
SSE	DOT® Snap Fastener Screw Stud 3/8" (Stainless)	#444105	—	—	Phillips Screwdriver
SSF	DOT® Snap Fastener Screw Stud 5/8" (Stainless)	#444110	—	—	Phillips Screwdriver
SSG	Twist Lock Fastener Eyelet (Stainless)**	Kit	—	—	#120445 or Flathead Screwdriver
SSH	Twist Lock Fastener 2 Hole Base (Stainless)**	#777600 or #777500	—	#104477	#102235 (p.197) or #104482 (p.197) + #100949 (C-C) (p.167) or Phillips Screwdriver (C-S) or #103543 (C-C) (p.177)
SSI	Twist Lock Fastener Clinch Plate (Stainless)**	Kit	—	—	—

\* Included with tool kit  
 \*\* Only sold in kits, not individual sale  
 \*\*\* Loxx® is compatible with the German TENAX® version and it not compatible with the English TENAX® products.

Cloth-To-Cloth (C-C) | Cloth-To-Surface (C-S)

# ROPE SIZE & SELECTION RECOMMENDATIONS

## WHAT SIZE LINE?

Line size and type depends on a number of factors including length of boat. Use the Line Size Recommendations table as a guide only (docking in open water, strong winds, or tides may require larger or additional lines).

Heavier lines may be needed for heavy, well-ballasted cruising boats or increased wind exposure due to greater freeboard and top hamper. Make sure all cleats are able to handle the line diameter. Double a 3/8" or 1/2" line rather than cleat a 5/8" or 3/4" line on too small a cleat.

## HOW MUCH LINE?

Genoa sheets are generally 1.5 times the length of a boat. For non-overlapping jibs, one boat length is usually enough. Spinnaker sheets are usually twice the length of a boat. We recommend measuring all other running rigging.

## TENSILE STRENGTH & LOADS

Tensile strength is the breaking load of new rope tested under laboratory conditions. Rope strength is averaged for new rope tested under ASTM test method D-6268. Estimate minimum tensile strength (new rope) by reducing the approx. average by 20%. Age, usage, and knots used will significantly lower tensile strengths.

Safe working load is minimum tensile strength divided by safety factor (5–12 for non-critical uses). Working load is a guideline for rope in good condition used in non-critical applications. Reduce load when life, limb, or valuable property are involved or where exceptional shock, sustained loading, or severe vibration may be experienced.

## WIRE HALYARD REPLACEMENT

Rope halyards are easier to handle and significantly lighter than wire halyards. Sta-Set X is an ideal replacement for wire halyards on cruising yachts and T-900 for race boats and large cruising yachts.

LINE SIZE RECOMMENDATIONS			
BOAT LENGTH	DOCK LINES	ANCHOR LINES	MOORING PENDANT
0'–20'	3/8"	3/8"	1/2"
20'–30'	1/2"	1/2"	5/8"
30'–35'	1/2"	1/2"	3/4"
35'–40'	1/2"	5/8"	7/8"
40'–45'	5/8"	3/4"	1"
45'–55'	5/8"	7/8"	1"
55'–65'	3/4"	1"	1-1/4"

WIRE HALYARD REPLACEMENT GUIDE					
7 x 19 Wire	1/8"	5/32"	3/16"	7/32"	1/4"
Sta-Set X	5/16"	3/8"	7/16"	1/2"	9/16"
T-900	1/4"	1/4"	5/16"	3/8"	7/16"

# CHOOSING THE CORRECT LINE

## STEP #1

Choose application.

## STEP #2

Choose type of sailing.

## STEP #3

Select boat size.

## STEP #4

Match color code for the best selection and diameter of line for given application.

To upgrade, modify "Type of Sailing." In most cases, choosing a better performing line will substantially lower the stretch and allow you to reduce diameter by 10–15%. The net result will be a lightweight, low-stretch line that will control sail shape more precisely.

- Sta-Set
- Sta-Set X
- ▶ Regatta Braid
- T-900
- ★ Spyderline
- Flight Line
- ✖ VPC

APPLICATION	TYPE OF SAILING	BOAT SIZE (FEET)							
		0–15	15–20	20–25	25–30	30–35	35–40	40–45	45–50
MAINSHEET	Cruising	▶ 5/16"	▶ 5/16"	▶ 3/8"	▶ 3/8"	▶ 7/16"	▶ 7/16"	● 1/2"	● 1/2"
	Club Racing	● 5/16"	● 5/16"	● 3/8"	● 3/8"	✖ 3/8"	✖ 3/8"	✖ 7/16"	✖ 7/16"
JIB SHEET	Cruising	● 1/4"	● 5/16"	● 5/16"	● 3/8"	● 3/8"	● 7/16"	● 7/16"	● 1/2"
	Club Racing	● 1/4"	✖ 5/16"	✖ 5/16"	✖ 3/8"	✖ 3/8"	✖ 3/8"	✖ 7/16"	✖ 7/16"
SPIN SHEET	Cruising	● 1/4"	● 1/4"	● 5/16"	● 5/16"	● 3/8"	■ 3/8"	■ 7/16"	■ 7/16"
	Club Racing	● 1/4"	● 1/4"	● 5/16"	● 5/16"	● 3/8"	● 3/8"	● 3/8"	■ 5/16"
LIGHT AIR SPIN SHEETS	Cruising	★ 3/16"	★ 3/16"	● 1/4"	● 1/4"	● 1/4"	● 5/16"	● 3/8"	● 3/8"
	Club Racing	★ 3/16"	★ 3/16"	● 1/4"	● 1/4"	● 1/4"	● 5/16"	● 3/8"	● 3/8"
TRAVELLER	Cruising	● 1/4"	● 1/4"	● 5/16"	● 5/16"	● 5/16"	● 3/8"	● 3/8"	● 3/8"
	Club Racing	● 1/4"	● 1/4"	● 5/16"	● 5/16"	● 5/16"	● 3/8"	● 3/8"	● 3/8"
AFTER GUY	Cruising	N/A	N/A	N/A	N/A	■ 5/16"	■ 3/8"	■ 7/16"	■ 1/2"
	Club Racing	N/A	N/A	N/A	N/A	■ 5/16"	■ 3/8"	■ 7/16"	■ 1/2"
MAIN HALYARD	Cruising	■ 1/4"	■ 5/16"	■ 5/16"	■ 3/8"	■ 3/8"	■ 7/16"	■ 7/16"	■ 1/2"
	Club Racing	■ 1/4"	■ 1/4"	■ 5/16"	■ 5/16"	■ 3/8"	■ 3/8"	■ 7/16"	■ 7/16"
JIB HALYARD	Cruising	■ 1/4"	■ 5/16"	■ 5/16"	■ 3/8"	■ 3/8"	■ 7/16"	■ 7/16"	■ 1/2"
	Club Racing	■ 1/4"	■ 1/4"	■ 1/4"	■ 5/16"	■ 5/16"	■ 3/8"	■ 3/8"	■ 7/16"
SPIN HALYARD	Cruising	● 1/4"	● 1/4"	● 5/16"	● 5/16"	● 5/16"	● 3/8"	● 3/8"	● 7/16"
	Club Racing	✖ 1/4"	✖ 1/4"	✖ 1/4"	✖ 1/4"	✖ 5/16"	✖ 5/16"	✖ 3/8"	✖ 7/16"
SPINNAKER TOPPING LIFT	Cruising	● 3/16"	● 3/16"	● 1/4"	● 5/16"	● 5/16"	● 3/8"	● 3/8"	● 7/16"
	Club Racing	■ 3/16"	■ 3/16"	■ 1/4"	■ 1/4"	■ 5/16"	■ 5/16"	■ 5/16"	■ 3/8"
FORE GUY	Cruising	● 3/16"	● 3/16"	● 1/4"	● 3/8"	● 3/8"	● 3/8"	● 3/8"	● 7/16"
	Club Racing	■ 3/16"	■ 3/16"	■ 1/4"	■ 1/4"	■ 5/16"	■ 3/8"	■ 3/8"	■ 7/16"

# SAIL HARDWARE COMPATIBILITY CHART

Each slug and slide was tested on a sail with 5/16" boltrope and a #2 spur grommet (#24105 without grommet) installed just behind the boltrope. Use this chart to determine which slugs and slides are compatible with each shackle. All slugs and slides can also be webbed in place without the use of shackles.

## POSITIONING SLUGS & SLIDES

### LUFF:

Position the top slug right below the headboard or in the headboard slots designed for slug attachment with webbing. Work down along the luff installing slugs approximately every 26". Avoid placing a slug too close to a reef grommet, rather position the slug at least as high above the grommet as the distance from the slug stop to the tack hook at the gooseneck. The bottom slug should, at the very least, be high enough to sit above the slug stop when the sail is raised.

### FOOT:

Position slugs or slides equally spaced about 15" apart along the foot of the sail.

SHACKLES	SLUGS								
	Screw-on Stainless Steel 3/4 x 1/2" #100043	Screw-on Stainless Steel 3/4 x 3/8" #100049	Screw-on Stainless Steel 1-1/16" #100047	Snap-in Plastic 7/8" #727	Snap-in Plastic 1-1/8" #728	Screw-on Plastic 3/4" #103037	Screw-on Plastic 15/16" #24106	Screw-on Plastic 1-1/8" #137	Screw-on Plastic 5/8" #24105
Stainless Steel Welded 5/16" #1390	✓	✓	✓	✓	✓	✓	✓	✓	✓
Stainless Steel Welded 7/16" #1391	✓	✓	✓	✓	✓	✓	✓	✓	✓
Allslip Slug 5/16" #1138			✓			✓			
Allslip Slug 3/8" #6981			✓			✓			
Allslip Slug 1/2" #1140			✓			✓			
All Nylon Round 5/16" #23307			✓	✓	✓	✓	✓	✓	✓
All Nylon Round 3/8" #23319			✓	✓	✓	✓	✓	✓	✓
All Nylon Round 1/2" #23308			✓	✓	✓	✓	✓	✓	✓
Stainless Bail Sail 5/16" #23312	✓	✓	✓		✓	✓	✓	✓	✓
Stainless Bail Sail 13/32" #23313	✓	✓	✓	✓	✓	✓	✓	✓	✓
Stainless Bail Sail 7/16" #23314	✓	✓	✓	✓	✓	✓	✓	✓	✓
Stainless Bail Sail 3/8" #67311	✓	✓	✓	✓	✓	✓	✓	✓	✓
Stainless Bail Sail 1/2" #67511	✓	✓	✓	✓	✓	✓	✓	✓	✓
SLIDES									
Selden Mast Plastic 7/16" #103038			✓	✓		✓	✓		
Selden Mast Plastic 9/16" #103039			✓	✓	✓	✓	✓		
Selden Mast Plastic 5/8" #103040			✓			✓		✓	
Allslip Slide 5/8" #1131			✓			✓			
Allslip Slide 3/4" #1132			✓			✓			
Allslip Slide 7/8" #1137			✓			✓			
All Nylon Internal Flat 5/8" #23309			✓	✓	✓	✓	✓		✓
All Nylon Internal Flat 3/4" #23310			✓	✓	✓	✓	✓	✓	✓
All Nylon Internal Flat 7/8" #23311			✓		✓	✓		✓	
Ronstan Internal Track Flat 7/8" #4524			✓						
Stainless Flat Internal Track 5/8" #1379			✓	✓	✓	✓	✓	✓	✓
Stainless Flat Internal Track 3/4" #1900			✓	✓	✓	✓	✓	✓	✓
Stainless Flat Internal Track 7/8" #1380			✓	✓	✓	✓	✓	✓	✓
External Sail Slide 5/8" #23301	✓	✓	✓				✓		✓
External Sail Slide 7/8" #23303	✓	✓	✓				✓		✓

# INDEX

## SYMBOLS

### 3M

Fast Cure 5200 Adhesive **163**  
Filament Strapping Tape **86**  
General Purpose Adhesive Cleaner **165**  
General Trim Adhesive **163**  
Marine Mildew Resistant Silicone **163**  
Silane Glass Treatment **181**  
Super 77 Spray Adhesive **163**  
Super Seam Tape **139**  
Super Trim Adhesive **163**  
Tape Primer 94 Adhesive Promoter **163**

3-Strand Rope **220**

3-Way Rail Corner **188**

#8 Cotton Duck **26**

303 Aerospace Protectant **165**

303 Fabric Guard **162**

303 Multi-Surface Cleaner **162**

## A

AAT-390 Marine & Exterior Adhesive **163**  
Accessory Carrying Case **171**

Acrylic Binding & Facing **140–141**

Acrylic Braid Soft Binding **140**

Acrylic Ruler **134**

Add-a-Cleat **195**

Adhesive-Backed Insignia Material **83**

Adhesive-Backed Nylon Velcro **151**

Adhesive-Backed Tapes **152**

Adhesive-Backed UV Dacron **152**

Adhesive Promoter **163**

Adhesives **163**

Adjustable Eye End **189**

Adjustable Palm **126**

Adjustable Strap Buckles **181**

Aerospace Protectant, 303 **165**

Air-Flow Tels **201**

Airx 700 Premium Spinnaker Cloth **82**

All Nylon Flat Sail Slides **202**

All Nylon Round Sail Slugs **202**

Allslip Slugs & Slides **204**

Allsport 4-Way Stretch Vinyl **38**

Anchor Riding Sail Kits **236**

Anefit Nylon Upholstery Thread **128**

Anodized Aluminum Headboards **198**

Anodized Aluminum Track **184**

Anti-Microbial Foam **93**

Anti-Wick Nylon Tape **145**

Antitwick Thread **128**

Aquaguard Zippers **159**

AquaGuard Zipper Sliders **159**

Aqua-Tite Green **162**

Assembled Collapsible Struts **200**

Asymmetrical Wire Lever Harness Clip **183**

ATN Mastclimber **241**

Awning Rope **223**

Awning Track **184**

Awning Track Mounting Clip **187**

## B

Bag Cloth **80**

Bag Kits **238**

Bags

Sew What! Book **43**

Balance Wheel, Monster II **105**

Balance Wheels **121**

Ball Point Needles **124**

Barrel Lock Closures **180**

Basting Tape **139**

Batten End Caps **212–213**

Batten Pocket End Protectors **213**

Battens **212–213**

Batting **94**

Beaclip Panel Mounting System **182**

Belt Covers **121**

Belts, Sewing Machine **118**

Bench Hook, Swivel **135**

Bendable I-Beam Curtain Track **185**

Big Book of Boat Canvas **239**

Bimini Kits **232–233**

Binder, 1" Swing **106, 123**

Binders **123**

Binding **140–143**

Binding Tape Maker **145**

Binding Tape Polyester **143**

Binnacle Wheel Cover Kits **236**

Blade Foam Cutter **91**

Blind Rivets **191**

Blocks **205–207**

Boat Blanket **87**

Boat Care Kits **164**

Boat Cushions DVD **43**

Boat Hardware **191**

Boat Vent **191**

Bobbin Box **135**

Bobbin Cases **120**

Bobbins **120**

Boeshield RUST FREE **162**

Boeshield T-9 Rust & Corrosion Protection **162**

Boltrope **153**

Books **43, 226, 239, 244**

Bosun's Chair Kit **241**

Brass Thimbles **215**

Brion Toss Splicing Wand **222**

Brun-Tuff Vinyl **26**

Buckles **183**

Bullet Blocks **206, 207**

Buoys **216**

Button Carrier, Curtain **187**

Button Forms **94**

Butyl Tape **163**

## C

Cable Cutters **215**

Cam Buckles **183**

Cam Cleats **208–209**

Cam-Lock Support Poles **191**

Cam-Matic Ball-Bearing Cleats **209**

Cam-Matic Kits **208**

Canvas Care & Cleaner **162**

Canvas Repair Kit **138**

Canvasworker's Guide **239**

Canvasworkers Tool Kit **199**

Captive Halyard Shackle **211**

Caribbean Signal & Courtesy Flags Book **244**

Carpet Binding **143**

Carry-All Tote Bag Kit **238**

Carrying Case **136, 171**

Carrying Case, Industrial **106**

Catamaran Batten End Cap **213**

Catamaran Clew Plate **198**

CDI Deck Hardware & Furling Line **194**

CDI Flexible Furlers **194**

Ceiling Bracket, RECMAR **185**

Ceiling Mount Curtain Track **187**

Hardware **187**

Ceiling Splicer, RECMAR **185**

Centerfold Acrylic Binding **140**

Chalk, Marking **134**

Channeling Fabric **33**

Chilewich Floor Covering **78**

Choosing the Correct Line **250**

Clamcleat **209**

Clear Acrylic Ruler **134**

Clear Twist Pins **135**

Clear Vinyl **88–89**

Cleats **208–209**

Clew Plate **198**

Clips **183**

Closed Cell Foam **93**

Closed Clamcleat **209**

Coated Outhaul Slugs **203**

Coats UVR Polyester Thread **130**

Cogged Flywheel Belts **118**

Coil Continuous Zippers **158**

Coil Finished Zippers **158**

Coil Zipper Sliders **160**

Collapsible Struts **200**

Collapsible Table **107**

Common Sense Eyelet Hole Cutter **177**

Common Sense Fasteners **176–177**

Common Sense Hand Punch **177**

Common Sense Stud Single Screw Driver **177**

Complete Canvasworker's Guide **239**

Composition Wax Cup **127**

Computer Eights **83**

Continuous Coil Zippers **158**

Continuous Support Tape **153**

Cording Feet **119**

Cording Foot for Large Welting **106**

Cordura 1000 Nylon **26**

Cotton Duck, #8 **26**

Cotton Duck - Marine Finished **26**

Courtesy Flags Book **244**

Cover Clips **180**

Cover Hook & Eyelet Set **182**

Cruiser's Spares for Ultrafeeds **106**

Crystal Clear **88–89**

Curtain Ball Carrier **185**

Curtain Hardware **185–187**

Curtain Track **185–187**

Curtain Track End Stop **185, 187**

Curved Hand Needle Assortment **126**

Curved Side Release Buckles **183**

Cushions DVD **43**

Cushion Underlining **94**

Cushion Wrap Silk Film **94**

Custom Sail Kits **225**

Cutting Block **173, 177, 197**

Cutting Foot **136, 137**

Cutting Mat **132**

## D

Dacron, All-Purpose **81**

Dacron Repair Tape **152**

Dacron Sail Tape **153**

Dacron, Supercruise **81**

Dacron Tape, Non-Adhesive **152**

Dacron Tramp Mesh **84**

Dacron, UV Coated **81**

Deck Hardware & Furling Line, CDI **194**

Deck Hinge **189**

Deck Mate Tool **167**

Deck Mount Plates **189**

Decorative Fringe **146**

Decorative Piping & Trim **146**

Deluxe Magnetic Sewing Guide **104**

Deluxe Seam Ripper **132**

Deluxe Shower Curtain Kit **185**

Die Sets **197**

DI Leather Needle **124**

Dinghy Blocks **207**

Ditty Bag Kit **238**

Dodger Kits **234–235**

DOT Durable Snap Fasteners **168–169**

Double Adjustable Side Release Buckles **183**

Double Braid Nylon Rope **221**

Double Pin Swivel Shackles **211**

Double Tether Kits **244**

Downhaul Hook **193**

Draft Tape **152**

Drapery Hooks **186**

Drapery Weights **186**

Drill Steady Tubing Tool **191**

D-Rings **183, 201**

Dritz Assorted Needles **126**

Dritz Start-to-Sew Kit **135**

Drogue Deployment Bag Kit **242**

Drogue Kits **242–243**

Dry-Fast Open Cell Foam **93**

Duffle Bag Kits **238**

Duplex Outlet & Wiring **120**

Dura Skrim Patterning Material **86**

DVD

Make Your Own Cushions DVD V.II **43**

Make Your Own Pillows, Shams & Bed Skirt DVD **43**

Re-Upholster Your Own Chair DVD **43**

Dyneema Webbing **149**

## E

Easy Action Bent Scissors **133**

Easy Install Turn Fasteners **180**

EasyKlip Midi **201**

E-Glass Battens **212**

Elbow Connector **188**

Electric Winch Handle **195**

Electronic Foot Controls **120**

End Stop, Curtain **185, 187**

Engel Hotknife **136**

Ergonomic Thread Snips **132**

Evolution Block-It **90**

Exit Blocks **207**

Extend-A-Snap **174**

External Headboards **198**

External Slides **204**

Extra Heavy Weight Nylon Webbing **149**

Eye Ends **189**

Eye & Jaw Swivel **211**

Eyelet Carriers **186**

Eyelet Die Sets **197**

Eyelet Grommets & Rings **196**

Eyestraps **207**

EZE TC-08 Long Nose Staple Gun **192**

EZE TC-08 Short Nose Staple Gun **192**

E-Z Lace Supreme **150**

EZ Set Stitch Length Plate **104**

E-Z Snap Zipper & Snap Lubricant **165**

## F

Fabric

Airx 700 Premium Spinnaker Cloth **82**

Allsport Stretch Vinyl **38**

Bag Cloth **80**

Batting **94**

Boat Blanket **87**

Brun-Tuff Vinyl **26**

Channeling Fabric **33**

Chilewich **78**

Clear Vinyl **88–89**

Cordura 1000 Nylon **26**

Cotton Duck, #8 **26**

Cotton Duck, Marine **26**

Crystal Clear **89**

Cushion Underlining **94**

Dacron, All Purpose

Leather Presser Feet **119**  
Leather, Sailmaker's **82**  
LED Light **104**  
Leechline **222**  
Leechline Cleat **209**  
Left Roping Zipper Foot **106**  
Lifeline Base **189**  
Lifeline Hook **182**  
Lifeline Kits **193**  
Lifeline Wire **193**  
Lift-The-Dot Deluxe Lever Hand Punch Tool **173**  
Lift-the-DOT Fasteners **173**  
Lift-the-DOT Hand Punch **173**  
Lift-the-DOT Hole Cutter **173**  
Lightweight Bent Trimmers **133**  
Long Arm Sewing Machines **114–116**  
Long Upholstery Hand Needle Assortment **126**  
Loop Loc **181**  
Loxx Locking Key **179**  
Loxx Locking Tool **179**  
Loxx Pull-It-Up Fasteners **178**  
Lubricant **118**  
Luff Reinforcement **153**  
Luff Tape **153**  
Luff Tape Conversion Kits **228**

## M

Magnetic Bobbin Holder **135**  
Magnetic Sewing Guides **136**  
Magnetic Thread Oiler **118**  
Mainsail Cover Kits **230–231**  
Mainsails: Design & Construction **226**  
Make Your Own Caribbean Signal & Courtesy Flags **244**  
Make Your Own Cushions DVD **43**  
Make Your Own Pillows, Shams & Bed Skirt DVD **43**  
Mallet **197, 198**  
Manila Line **222**  
Marine Hook & Loop **151**  
Marine Mildew Resistant Silicone **163**  
Marine Topping **26**  
Marine Ultra Seal **154**  
Marine V-Seal **154**  
Marking Chalk **134**  
Marking Pencil **134**  
Mastclimber **241**  
Matching Thread Colors to Sunbrella **246–247**  
Maxi Round Ring With Bar **201**  
McLube Sailkote **165**  
Medium Weight Nylon Webbing **149**  
Mesh & Netting  
Fiberglass Mesh **85**  
Mosquito Netting **85**  
Phifertex, Phifertex Plus **74–77**  
Polyester Mesh **85**  
Trampoline Mesh **84**

Metal Bobbins **120**  
Metal Clamcleat **209**  
Metal Polish **162**  
Micro Blocks **205**  
Mold & Mildew Stain Remover **165**  
Monofilament Thread **128**  
Monofilm **89**  
Monster II Balance Wheel **105**  
Morbern Hexx & Shock **37**  
Morbern Seabrook Channeling Fabric **33**  
Mosquito Netting **85**  
Motor Pulleys **121**  
Motors, Sewing Machine **118**  
Mylar Basting Tape **139**

## N

Naugahyde All-American **35**  
Naugahyde Nauga Soft **39**  
Naugahyde Universal **34**  
Naugahyde Welting/Piping **147**  
Needle Assortment Pack **106, 125**  
Needle Plates **121**  
Needles **124**  
Needle Threader **126**  
Netting **85–86**  
New England Classic Rope **220**  
New England Ropes **218–221**  
New England Spun Classic Rope **220**  
Nicopress Installation Tool **215**  
Nicopress Sleeves **215**  
Non-Adhesive Dacron Tape **152**  
Nu-Foam, Poly-Fil **93**  
Numbers **83**  
Nylon Bag & Flag Cloth **80**  
Nylon Block Carrier **185**  
Nylon Flat Sail Slides **202**  
Nylon Headboards **198**  
Nylon Piston Snaps **214**  
Nylon Round Sail Slugs **202**  
Nylon Tape/Ribbon **152**  
Nylon Webbing **148–149**  
Nylon Wheel Carrier **185**

## O

Odyssey **28**  
Oil, Sewing Machine **118**  
One-Way Fasteners **178**  
Ordering & Payment Information **256**  
Presser Feet **119**  
Press-On Swedish Snaps **214**  
Pre-wound Bobbins **131**  
Professional Long Arm Sewing Machines **114–116**  
Professional Rivet Tool **171, 191**  
Professional Sewing Machines **114–116**  
Prong Bending Tool **174**  
Pulleys **121**  
Pull Tabs **159**  
Pull-the-DOT Fasteners **178**  
Pultruded Battens **213**  
Punch Set **197**  
Permalock Non-Metal Fasteners **180**

## P

Phifer Geobella Fabric **66–73**  
Phifertex, Phifertex Plus **74–77**  
Pillow Forms **95**  
Pillow Protector Fabric **95**  
Pillows, Shams & Bed Skirt DVD **43**  
Pinking Shears **133**  
Pin-On Drapery Hooks **186**  
Pins **135**  
Piping Cord **147**  
Piston Snaps **214**  
Plain Grommets **196**  
Plastic Cover Hook & Eyelet Set **182**  
Plastic Inserts **203, 214**  
Plastic Slides **203**  
Plastipane **88–89**  
Pocket Elastic **213**  
Point Hudson Phid **222**  
Pole Base **191**  
Polyester Batting **94**  
Polyester Binding Tape **143**  
Polyester Carpet Binding **143**  
Polyester Fiberfill **93**  
Polyester Mesh **85**  
Polyester Thread **130–131**  
Polyester Twine **127**  
Polyester Webbing **148**  
Polyform  
Fenders & Buoys **216**  
Inflation Adapter **217**  
Mini Pump **217**  
Poly Grip Harness Clip **183**  
Polypropylene Webbing **149**  
Polyurethane Foam, Fabric Backed **93**  
Posi-Pin **121**  
Positraction Belts **118**  
Power Twist V-Belt **118**  
Pre-Cut Sail Numbers **83**  
Prefabricated Mainsail Boltrope **153**  
Premium 3-Strand Nylon Rope **220**  
Premium Cutting Blocks **197**  
Pres-N-Snap Bench Mount **175**  
Pres-N-Snap Dies **175**  
Pres-N-Snap Installation Tool **175**  
Presser Feet **119**  
Press-On Swedish Snaps **214**  
Pre-wound Bobbins **131**  
Professional Long Arm Sewing Machines **114–116**  
Professional Rivet Tool **171, 191**  
Professional Sewing Machines **114–116**  
Prong Bending Tool **174**  
Pulleys **121**  
Pull Tabs **159**  
Pull-the-DOT Fasteners **178**  
Pultruded Battens **213**  
Punch Set **197**  
Push Pins **135**

## Q

Quick Attach Hardware **193**  
Quick-Fit Kit **174**  
Quick Pins **193**  
Quick Release Deck Hinge **189**  
Quick Release Pin **188**  
Quick Release Pin Frame Fittings **188**

## R

Ratchet, Micro Marine **222**  
R Blade **136, 137**  
RECMAR  
Bendable I-Beam Curtain Track **185**  
Curtain Ball Carrier **185**  
Curtain Track End Stop **185**  
I-Beam Ceiling Bracket **185**  
I-Beam Track Ceiling Splicer **185**  
I-Beam Track Wall Bracket **185**  
I-Beam Track Wall Splicer **185**  
Nylon Block Carrier **185**  
Nylon Wheel Carrier **185**  
Plastream Sail Battens **212**  
Shower Curtain Kit **185**  
Snap-In Retainer Catch **185**  
Stainless Steel J Hook **185**  
Wrinkle Band Hooks **185**  
Wrinkle Band Tape **185**

Rectangle Base **188**  
Rectangular Sail Cover Kits **237**  
Reflex Biocide Foam **93**  
Regalite **88–89**  
Regatta Braid Rope **219**  
Regatta Lite Rope **219**  
Repair Kits **138**  
Repair Tapes **152**  
Retaining Ring **121**  
Re-Upholster Your Own Chair DVD **43**  
Revolving Punch & Replacement Tubes **197**  
Rheostat Carbon Pile Foot Control **120**  
Rigging Kit **215**  
Rigging Shackles **210**  
Rigging Tape **152**  
Rigid Support Strut Kit **200**  
Rings **201**  
Ripstop Spinnaker Cloth **80**  
Rivets **171, 191, 198**  
Rivet Tool **171, 191**  
Roller Furling Bail **195**  
Roller Furling Fairlead **195**  
Ronstan  
Cleat **209**  
Fairlead Dead Eye **195**  
Saddle **195**  
Swivel Shackles **211**  
Track Slide **204**  
Track Slug **204**

Rope **218–221**  
Rope Size & Selection Recommendations **250**  
Rope Splicing Tools **222**  
Rope Thimble **215**  
Roping Presser Foot **119**  
Rotary Center Release Buckles **183**  
Rotary Cutters **132**  
Rotary & Shuttle Hooks **120**  
Round Point (Sharp) Needle **124**  
Round Ring **201**  
Rubber Cutting Block **173, 177**  
Ruler **134**  
Ruler, Patterning **134**  
Rust & Corrosion Protection **162**

## S

Sacrificial Sail Sun Cover Kits **229**  
Saddle **195**  
Safe-T-Solve, Iosso **165**  
Safety Harness Kit **244**  
Safety Tether Kits **244**  
Sail Battens **212–213**  
Sailcloth **80, 81, 82**  
Sail Cover Instruction Booklet **226**  
Sail Cover Kits **230–231**  
Sail Duffle Bag Kits **238**  
Sail Hanks **214**  
Sail Hardware Compatibility Chart **251**  
Sail Kits **225**  
Sailkote **165**  
Sail Line Cleat **209**  
Sailmaker's Apprentice **239**  
Sailmaker's Leather **82**  
Sailmaker's Library **226**  
Sailmakers Tool Kit **199**  
Sail Numbers **83**  
Sail Pack Kits **231**  
Sail Repair Kit **138**  
Sail Repair Manual **153**  
Sailrite Blade Foam Cutter **91**  
Sailrite Canvas Patterning Ruler **134**  
Sailrite Edge Hotknife **137**  
Sailrite Fabricator Sewing Machine **110**  
Sailrite Flex20 LED Light **104**  
Sailrite Professional Sewing Machines **114–116**  
Sailrite Safety Harness Kit **244**  
Sailrite Ultrafeed Sewing Machine Accessories **104–106**  
Sailrite Workhorse Servo Motor **109**  
Sail Snaps **214**  
Sail Tape **153**  
Sail Tie Kit **150**  
Sail Track Stops **204**  
Salsa Line Rope **220**  
Scissors **133**  
Scratch Awl **192**  
Screw-On Plastic Shackles **203**

Screw Stop **187**  
Scribe-All Marking Pencil **134**  
SD1 Needles **124**  
Seabrook Vinyl **36**  
Seabrook Welting/Piping **147**  
Sea Mark **22**  
Seam Ripper **132**  
Seam Sealer **162**  
Selden Mast Plastic Slides **203**  
Self-Centering Punch Set **197**  
Self-Healing Cutting Mat **132**  
Series Drogue Kits **242–243**  
Serv7 Needles **124**  
Servo Motor, Workhorse **109**  
Sewable D-Ring **201**  
Sewer's Aid Lubricant **118**  
Sewing Awl Kit **127**  
Sewing Fence **136**  
Sewing Gauge Ruler **134**  
Sewing Guide, Deluxe Magnetic **104**  
Sewing Guides **136**  
Sewing Kits **135**  
Sewing Machine Belts **118**  
Sewing Machine Motors **118**  
Sewing Machine Needles **124**  
Sewing Machine Oil **118**  
Sewing Machines  
Sailrite Fabricator **110**  
Sailrite Professional Series **114–116**  
Sailrite Ultrafeed **96–105**  
Sewing Palm **126**  
Sew-On Tabs **186**  
Sew-On Tab Tape **186**  
Sew What! Bags **43**  
Shackles **202–203, 210–211**  
Shears **133**  
Sheet Bag Kit **238**  
Shelter-Rite **31**  
Shelter-Rite Tape **152**  
Shirring Tape **185**  
Shock Cord **222**  
Shock Cord Cover Clips **180**  
Shock Cord Hooks **180**  
Shock Cord Lacing Knobs **180**  
Shoulder Pad **181**  
Shower Curtain Kit **185**  
Shroud Turnbuckle Cover Kits **239**  
Shuttle Hooks **120**  
Side Mounts **189**  
Side Release Buckles **183**  
Signal Flag Kit **244**  
Silicone **163**  
Silk Film **94**  
Single Tether Kits **244**  
Sister Clip **215**  
Sleeve Furling Cover Kits **228**  
Slides **202–204**

Sliding Side Mount **189**  
Slugs **202–204**  
Small Plastic Closed Clamcleat **209**  
SNAD Adhesive-Backed Fasteners **181**  
Snap Clip for Flags **244**  
Snap Clips **183**  
Snap Extender **174**  
Snap Fastener Installation Tool **167**  
Snap Fastener Kit **167**  
Snap Fasteners **166–179**  
Snap Fastener Starter Kit **174**  
Snap Hook **183**  
Snap Hook Swivel **183**  
Snap-In Plastic Shackles **203**  
Snap-In Retainer Catch **185**  
Snap Lubricant **165**  
Snap-On Carrier **187**  
Snap-On Tape **187**  
Snap-On Windlace **145**  
SnapRite Dies **171, 172**  
SnapRite Mandrels **172**  
Snaprite Starter Fastener Kit **172**  
SnapRite Surface Mount Stud Die **171**  
SnapRite System **170–171**  
SnapRite Twist-Lock Stud Die **172**  
Snaps, Jib/Genoa **214**  
Snap Together Button Forms **94**  
Snap Together Grommets **196**  
Soapstone Pencil **134**  
Softouch **30**  
Soft Touch Pillow Forms **95**  
Soldering Iron, Weller **136**  
Solid Stainless Steel Thimbles **215**  
Spectra Webbing **149**  
Speedy Stitcher Sewing Awl Kit **127**  
Spinnaker Cloth **80–81**  
Spinnaker Hoops **201**  
Spinnaker Launching Bag Kits **239**  
Spinnakers: Design & Construction **226**  
Spinnaker Sock Kits **227**  
Splicing Tools **222**  
Spline Cording **223**  
Split Side Mount **189**  
Split Stainless Steel Thimbles **215**  
Spreader Boot Kits **239**  
Spring Ball **191**  
Spring Clamps **86**  
Spring Clip **183**  
Spring Snap **183**  
Spur Grommet Die Sets **197**  
Spur Grommets **196**  
SpyderLine Rope **220**  
Stainless Bail Sail Slugs **202**  
Stainless Flat Track Slides **203**  
Stainless Screw Shackles **203**

Stainless Steel Thimbles **215**  
Stainless Steel Welded Slugs **202**  
Stamoid **24**  
Stamoid Binding **142**  
STAMOID Marine Protective Cream **164**  
STAMOID Marine Protective Spray **164**  
Stanchion Base **189**  
Stanchion Eye **189**  
Stanchion Hardware **189**  
Stanchion Sleeve with Eye **189**  
Staple Gun **192**  
Staple Remover **192**  
Staples **192**  
Star Webbing Adjuster **181**  
Sta-Set Rope **219**  
Sta-Set X Rope **219**  
Stationary Binder **123**  
Stayput Fasteners **180**  
Stayput Spin Cut Tool **197**  
Stayput Tent Wall Hook **182**  
Staysails: Design & Construction **226**  
Stormsails: Design & Construction **226**  
Strap Eye **182**  
Strataglass **88–89**  
Strataglass Protective Cleaner **164**  
Strataglass Protective Polish **164**  
Stretch Vinyl **38**  
Struts **200**  
Sun-Blocker Clips **200**  
Sunbrella  
Acrylic Binding & Facing **141**  
Acrylic Braid Soft Binding **140**  
Centerfold Acrylic Binding **140**  
Decorative Fringe **146**  
Decorative Piping & Trim **146**  
Facing **141**  
Marine Grade Fabric **14**  
Plus **19**  
Supreme **20**  
Unity **20**  
Upholstery Fabric **40–61**  
Webbing **148**  
Sunbrella Sun Cover Kits **229**  
Suncor  
Adjustable Webbing Sliders **181**  
Asymmetrical Wire Lever Harness Clip **183**  
Double Pin Swivel Shackles **211**  
Eye & Jaw Swivel **211**  
Fixed Eye Snap Shackles **211**  
Flat Webbing Hook **182**  
Footman's Loop **182**  
Lifeline Kits **193**  
Lifeline Wire **193**  
Poly Grip Harness Clip **183**  
Quick Attach Hardware **193**

Spring Clip **183**  
Star Webbing Adjuster **181**  
Strap Eye **182**  
Swivel Web Clip **183**  
Sun Cover Kits **229**  
Sunguard UVR Polyester Thread **130**  
Sunstop Polyester Thread **130**  
Super 77 Spray Adhesive **163**  
Supercruise Dacron **81**  
Super Seam Tape **139**  
Super Tramp **84**  
Super Trim Adhesive **163**  
Support Poles **191**  
Support Strut Kit **200**  
Support Tape **153**  
Supreme Poly-fil Pillow Forms **95**  
Surface Mount Curtain Track **187**  
Surface Mount Disk Hook **151**  
Sur Last **29**  
Surlast Binding **143**  
Swage-It Rigging Kit **215**  
Swedish Snaps **214**  
Swing-Away Binder **123**  
Swing Gauge **136**  
Swivel Bench Hook **135**  
Swivel Shackles **211**  
Swivel Web Clip **183**

## T

T-9 Rust & Corrosion Protection **162**  
T-900 Rope **221**  
Table  
Ultrafeed Collapsible Sewing Table **107**  
Ultrafeed Industrial Sewing Table **108**  
Tack Plates **198**  
Tailors Chalk **134**  
Take-Up Springs **120**  
Tape Maker **145**  
Tape Measure **134**  
Tapered Battens **212**  
Tapes **152**  
Targa Premium Canopy **82**  
Teak Cleaner **165**  
Teak Oil **165**  
Webbing **148**  
TEAR AID **152**  
Tear Mender **163**  
Tell-Tales **201**  
Tension Assembly **120**  
Tether Kits **244**  
Thermozite Thermal-Acoustic Insulation **90**  
Thimbles **215**  
Thread **130–133**  
Antiwick **128**  
Gore Tenara **129**  
Monofilament **128**  
Profilen **129**  
PTFE **129**  
Upholstery **128**

Thread Assortment Pack **106**  
Thread Clippers **132**  
Thread & Needle Recommendations **245**  
Thread Nippers **132**  
Thread Oiler **118**  
Thread, Polyester **130**  
Thread Snips **132**  
Thread Stand, Integrated **105, 122**  
Thread Stands **122**  
Throated Sail Cover Kits **230**  
Throated Sail Covers **230**  
Thumb Knob **200**  
Tiller Cover Kit **240**  
Tonneau Cover **90**  
Tool Kits  
Canvasworkers Tool Kit **199**  
Sailmakers Tool Kit **199**  
Top Gun **25**  
Top Gun 1S **27**  
Top Notch 9 **21**  
Top Notch 9 Binding **144**  
Top-Snapper **167**  
Tote Bag Kits **238**  
T-Pins **135**  
Track, Awning **184**  
Track, Curtain **186**  
Track Stops **204**  
Trampoline Mesh **84**  
Trimmable Butyl Tape **163**  
Trim Tapes **152**  
Trunkliner **90**  
Tube Cutting Tool **191**  
Tubing **190**  
Tubing Connectors **188**  
Tubular Webbing **148**  
Turnbuckle Cover Kits **239**  
Twine, Polyester **127**  
Twisted Manila Line **222**  
Twist Lock Driver Installation Tool **174**  
Twist Pins **135**  
Twist Shackles **210**  
Tylaska Dual Cavity Installation Die **177**

## U

Ultrafeed Collapsible Sewing Table **107**  
Ultrafeed Industrial Carrying Case **106**  
Ultrafeed Industrial Sewing Table **108**  
Ultrafeed Sewing Machine **96–105**  
Accessories **104–106**  
Ultrafeed Sewing Machine Motors **118**  
Ultrafeed Wooden Base **106**  
Ultrasuede HP **73**  
Universal Deck Hinge **189**  
Universal Tee **188**

Upholstery Hand Needle Assortment **126**  
 Upholstery Thread **128**  
 UV Dacron Sail Tape **153**  
 UV Insignia Sun Cover Kits **229**  
 UVR Polyester Thread **130–131**

**V**  
 Velcro **151**  
 Velcro, Adhesive-Backed **151**  
 VELCRO Cement **151**  
 VELCRO Circles **151**  
 Vent Grommet Die Set **197**  
 Vent Grommets **196**  
 Vertical Clamcleat **209**  
 Vertical Mount Curtain Track **187**  
 Vinyl Care **164**  
 Vinyl Welting/Piping **147**  
 Vislon Continuous Zippers **156**  
 Vislon Finished Zippers **156, 157**  
 Vislon Zipper Sliders **160**  
 Vislon Zipper Stops **160**  
 VPC Hybrid Performance Rope **221**

**W**  
 W-1 Hand Press **72**  
 Wall Bracket, RECMAR **185**  
 Wall Splicer, RECMAR **185**  
 Washable Blue Wonder Marker **134**  
 Wax Cup **127**

Weather Stripping **154**  
 Webbing **148–149**  
 Webbing Hardware **183**  
 Webbing Sliders **181**  
 Webbing Strap Kit **150, 233**  
 Weblon Binding **142**  
 Weblon Regatta **23**  
 Weller Hotknife Tip **136**  
 Weller Soldering Iron **136**  
 Wheel Cover Kits **236**  
 Whipping Twine **127**  
 White Plastic Hoops **203**  
 Winch Cover Kit **240**  
 WinchRite Cordless Winch Handle **195**  
 Windlace **145**  
 Window Kit **89**  
 Window Material **88–89**  
 Wire Cover Hooks **182**  
 Wire Rope **222**  
 Wire / Rope Thimble **215**  
 Wm & Smith Co. Hand Needles **126**  
 Workhorse Servo Motor **109**  
 Wrinkle Band Hooks **185**  
 Wrinkle Band Tape **185**

**X**  
 Xtreme Seal **154**

**Y**  
 Yachtsman Sail Repair Kit **138**  
 Yacht Soap Concentrate **164**

**YKK**  
 Adjustable Strap Buckles **181**  
 Aquaguard Zippers **159**  
 Barrel Lock Closures **180**  
 Coil Zippers **158**  
 Curved Side Release Buckles **183**  
 Double Adjustable Side Release Buckles **183**  
 D-Rings **183**  
 Ladderlock Buckle **181**  
 Loop Loc **181**  
 Rotary Center Release Buckles **183**  
 Side Release Buckles **183**  
 SNAD Adhesive-Backed Fasteners **181**  
 Snap Hook Swivel **183**  
 Tri-Bar Adjustable Webbing Sliders **181**  
 Vislon Zippers **156**  
 Zipper Sliders **160–161**  
 Zipper Stops **158, 160**

**Z**  
 Zigzag Roller Presser Foot **119**  
 Zipper Lubricant **165**  
 Zipper Presser Foot **106, 119**  
 Zipper Pull Tabs **159**  
 Zippers **155–159**  
 Zipper Sliders **160–161**  
 Zipper Stops **158, 160–161**  
 Zipper Cool Kit **165**

## SHIPPING

### SHIPPING OPTIONS

Orders are typically shipped within 1 to 2 days of receipt excluding weekends and holidays. For air shipments (FedEx 2Day or Overnight), the order cutoff time is 12 noon EST for guaranteed departure that day. Air services count only business days (Monday-Friday), so if you place an order on Thursday before 12 noon EST and choose 2nd day air, your order will arrive Monday.

#### United States:

- FedEx Ground (to businesses): 1–5 business days (most locations)
- FedEx Home Delivery (to residential): 1–5 business days (most locations)
- FedEx 2Day Air: 2 business days (most locations)
- FedEx Overnight Air: End of next business day (most locations)
- U.S. Postal Service (Priority Mail): 3–10 days (excluding Sundays). PO boxes and APO/FPO addresses accepted. Limited tracking.

#### International:

- FedEx International Economy: 2–5 business days (excluding customs)
- FedEx International Priority: 1–3 business days (excluding customs)
- Post Office: Typically 7–14 days. Size and weight restrictions vary by country. No surface mail.

### SHIPPING CHARGES

The easiest way to see available shipping methods and charges is in the shopping cart. Add the items to your shopping cart and click "shipping estimates". Select your country and zip code/postal code (if required), then click "calculate".

Sailrite does not offer third party billing or COD.

#### International Shipping:

Our FedEx International Economy and Priority rates include FedEx brokerage fees. Any duties, taxes or additional fees (often categorized under brokerage fees) assessed by your country cannot be quoted and are your responsibility. Sailrite will provide adequate clearance documents to the carrier/broker. Should you be contacted by the carrier with a request for further documentation, please contact Sailrite immediately for supporting documentation. It is your responsibility to determine whether an import license is required based on the items purchased.

Sailrite is not responsible for any fees, charges, delays or problems caused by shippers, customs, or paperwork once the shipment leaves our dock.

### REFUSED OR UNDELIVERABLE SHIPMENT:

If for any reason you refuse a shipment or it is returned undeliverable, you will be responsible for delivery both ways.

### SHIPPING RESTRICTIONS

Flammable items can ONLY be shipped FedEx Ground or Home Delivery to the 48 contiguous United States.

#### FedEx

Max. Product Length (shipped): 96" (8 ft)  
 Max. Length & Girth (combined): 130"  
 No APO/FPO or PO Box addresses.

#### U.S. Postal Service (US shipments)

Max. Product Length (shipped): 92"  
 Max. Length & Girth (combined): 108"  
 Ships to APO/FPO or PO Box addresses.

# Didn't see what you were looking for?

We have even more fabric, supplies and tools online at [Sailrite.com](http://Sailrite.com).

## PAYMENT METHODS

We accept credit cards (Visa, MasterCard, Discover and American Express), checks, money orders, and wire transfers (for orders over \$500) in U.S. funds. Orders paid by check will be held for 10 days or until the check clears. In the event your check is dishonored or returned for any reason, you authorize us to electronically (or by paper draft) re-present the check to your bank account for collection of the amount on the check, plus a \$25.00 fee as permitted by state law.

We do not ship cash on delivery (COD).

## RETURNS

Items may be returned within 30 days for a full refund less delivery. If a package is refused, or returned as undeliverable, return shipping will be deducted from the amount refunded. The item being returned must be in the same condition as it was sent, including all original packaging and tags. A return authorization (RA) number is required to be printed on the outside of all packaging—call or email Customer Service with your CS# or INV# for an RA. All returns must be received within 30 days of original ship date. Returns after 30 days are not accepted.

**INTERNATIONAL RETURNS:** If you are returning an order internationally, you are responsible for shipping, duties, taxes and brokerage fees. Sometimes these charges are invoiced by the carrier well after returns have been processed. We reserve the right to bill these fees even after credits for merchandise are made.

Packages that are refused at delivery outside of the United States will not be accepted by Sailrite. If arrangements for payment and delivery are not made within the carrier's allotted timeframe (often just a few days), such packages are deemed abandoned and are destroyed by customs. If you refuse a package you will not receive the goods and no refund will be made by Sailrite. If you wish to return the goods, you must receive the package and then start the return process with a Return Merchandise Authorization (RMA).

**ITEMS THAT MAY NOT BE RETURNED:** Special orders, sail kits, custom-made items, custom cut items, Ultraleather, Brisa, Brisa Outdoor, Ultrasuede, Chilewich, Infinity, 1 yard fabric orders, foam, guidebooks, samples, DVDs, gift certificates or any item that has been altered in any way (e.g. cut, sewn, marked on, or laminated).

**DAMAGES / DEFECTS:** In the event of a product defect, call Sailrite within 7 days. If damage is incurred due to shipping, contact the carrier directly or call us within 7 days. Save all packaging! The carrier will not process your claim without the packaging. No claims will be processed after 30 days.

## ORDER TRACKING

Packages shipped by FedEx® are trackable. If a valid e-mail address is provided, a shipping confirmation with tracking number will be sent when the order is shipped. Visit [www.fedex.com](http://www.fedex.com) to enter the tracking number and check the progress of your shipment. Customize your delivery (ie. leave delivery instructions, change delivery address, receive status updates, sign for a package, etc.) by signing up for FedEx Delivery Manager® at [www.fedex.com/delivery](http://www.fedex.com/delivery).

USPS offers limited tracking information. Packages are only scanned when received and delivered. Visit [www.usps.com](http://www.usps.com) and enter the tracking number to check the progress of your shipment. Samples sent by First Class Mail cannot be tracked.

If you have not received a shipping confirmation, your order has not been shipped, the email address provided was invalid, or the email was blocked by your spam filter.

## SAILRITE POLICIES

**WARRANTIES:** Warranties are the sole responsibility of the manufacturer. We will do all we can to expedite warranty claims but final determination of warranty claims rest with the manufacturer of the product. Sailrite's liability is limited to the value of the goods purchased.

**GUARANTEE:** We do our best to satisfy every order and request accurately and completely. If you are not satisfied with your order, please give us a call and we will make it right.

**PRICES:** All prices are in U.S. dollars. Prices listed do not include shipping, handling, taxes, and/or duties. Sailrite reserves the right to change prices if necessary due to price increases from original manufacturers.

If after placing an order from Sailrite.com, you see that Sailrite has a current mark down on the price of any of the items in your order, we will gladly offer a price adjustment within ten days of the date on which you placed your order. Price adjustments are only available on items originally purchased at full retail price where no promo codes were used (including free shipping promotions). Price adjustments are not available for Trade Program customers. Each item purchased is only eligible for one price adjustment. To request a price adjustment, contact Customer Service at [support@sailrite.com](mailto:support@sailrite.com) and include your order details and the item(s) you believe are eligible for a price adjustment.

Visit [Sailrite.com](http://Sailrite.com) for current pricing. Sunbrella® Marine Grade & Plus fabrics have a required Minimum Advertised Internet Price displayed online. Place these items in your shopping cart online to view lowest pricing.

**COLORS:** We have made every effort to display the colors and textures of our products as accurately as possible, but we cannot guarantee 100% accuracy. We recommend ordering a fabric sample to verify the color before final purchase. Our samples are pre-cut and not guaranteed to be from the same bolt or dye lot as your fabric. Samples may not show all the colors or pattern of a fabric, to see a full color sampling, order a full yard.

**PRODUCT AVAILABILITY:** We try our best to make sure everything you see in this catalog is continuously for sale. However, due to the nature of the textiles industry, we cannot guarantee that fabrics displayed won't be discontinued.

**FABRIC DEFECTS:** We only sell first quality fabrics, but even first quality fabrics can have flaws. We will make every effort to avoid sending a flaw with fabric cuts under 5 yards. If longer cuts are required, we recommend ordering additional fabric to compensate for the occasional flaw. Manufacturer flaw tags can be found on the edge of the fabric so the flaws can be avoided or inconspicuously placed.

**PERSONAL PHOTOS:** Any photos or letters we receive may be used in our catalog, website, or advertising unless otherwise informed.

**PRIVACY:** Sailrite does not sell or trade our mailing list, nor do we offer any personal information to outside groups about our customers.

**RECYCLE:** Sailrite plastic bag packaging is recyclable (#4 plastic).

**WARNING:** Some products may be fabricated from materials which may contain chemicals known to the State of California to cause cancer, birth defects or other reproductive harm.

**FABRIC PACKAGING:** Most fabric orders will be rolled for shipment. However, 1- and 2-yard orders may be folded. Orders of Cotton Duck, Polyester Batting, Dust Cover, Minky, Soft Tramp Mesh (5 yards or less), Boat Blanket (6 yards or less), Polytex (10 yards or less), Nylon Bag & Flag Cloth, Bag Mesh, Pillow Protector Fabric, Softline (30 yards or less), Mosquito Netting and Patterning Material (50 yards or less) will always be folded.

## BACKORDER POLICY

**U.S. ORDERS:** Orders will be held up to 5 days to ship everything complete. If the backorder is expected to take longer, all in-stock items will be shipped and any backorder item(s) will ship separately upon arrival (no additional delivery charges if a backorder is sent separately) unless otherwise specified by the customer.

**INTERNATIONAL ORDERS:** Orders will be held up to 7 days to ship everything complete. Should an item on the order take longer to receive, we can (1) continue to hold the order until the backordered item(s) arrive, (2) delete the item(s) from the order, or (3) suggest a product substitution (when possible). You will be notified of your options via email.

# ORDERING & PAYMENT INFORMATION

Shop Online:

**Sailrite.com**

or Call:

**800.348.2769  
260.244.4647**

fax: 260.818.2005

## Store Location & Hours:

Sailrite Enterprises, Inc.  
2390 East 100 South  
Columbia City, IN 46725  
USA

Monday–Friday:  
8AM–5PM EST

On-site pickup is available, but because we are a warehouse facility we are not set-up to accommodate walk-in, retail customers. If you would like a tour of our facility, please call and schedule one in advance of your visit.

## Questions or Comments?

Email: [info@sailrite.com](mailto:info@sailrite.com)

## Special Orders:

If you think we may be able to get an item that is not in our catalog, please ask! We accept special orders, but they may not be returned.

## Sailrite Accepts:



## Sailrite Ships:





**Sailrite Enterprises, Inc.**

2390 East 100 South  
Columbia City, IN 46725  
Sailrite.com

PRSRT STD  
U.S. Postage  
**PAID**  
Columbia City, IN  
Permit #238

Current Resident or:



**ADD A  
LITTLE DIY  
TO YOUR  
FEED** 



Share your latest projects, repairs, workroom photos and more using **#SewSailrite** and we might feature your photo!



**We're now sharing snapshots from our DIY lifestyle on Instagram!**

Follow us to see behind the scenes views of our projects here at Sailrite, meet our DIY crew, be inspired by new products and see what other DIYers like you are creating.



123\*1

©2018 All rights reserved